



US00D448250B1

(12) **United States Design Patent**
Brangle et al.

(10) **Patent No.:** **US D448,250 S**

(45) **Date of Patent:** **** Sep. 25, 2001**

(54) **COOLER**

(76) Inventors: **Patrick J. Brangle**, 1123 Sanford Ave.;
Michael C. Polizzi, 9659 Chamberlin
Dr., both of St. Louis, MO (US) 63139

(**) Term: **14 Years**

(21) Appl. No.: **29/119,431**

(22) Filed: **Feb. 29, 2000**

(51) **LOC (7) Cl.** **07-01**

(52) **U.S. Cl.** **D7/606**

(58) **Field of Search** D7/604-606, 607;
D3/202, 232, 270, 271, 246; 62/457.1,
457.7, 371, 372, 430; 383/109-110

(56) **References Cited**

U.S. PATENT DOCUMENTS

D. 96,520	*	8/1935	Thucaky	D3/246
D. 101,792	*	11/1936	Resnick	D3/246
D. 351,320	*	10/1994	Minor	D7/606

* cited by examiner

Primary Examiner—Terry A. Wallace

(57) **CLAIM**

The ornamental design for a cooler, as shown and described.

DESCRIPTION

FIG. 1 is a perspective view of a cooler showing our new design;
 FIG. 2 is a top view thereof
 FIG. 3 is a bottom view thereof
 FIG. 4 is a front view thereof
 FIG. 5 is a back view thereof
 FIG. 6 is a right side view thereof
 FIG. 7 is a left side view thereof
 FIG. 8 is a perspective view of an alternate embodiment of FIG. 1;
 FIG. 9 is a front view thereof
 FIG. 10 is a back view thereof
 FIG. 11 is a top view thereof
 FIG. 12 is a bottom view thereof
 FIG. 13 is a right side view thereof
 FIG. 14 is a left side view thereof
 FIG. 15 is a perspective view of an alternate embodiment of FIG. 1;
 FIG. 16 is a top view thereof
 FIG. 17 is a bottom view thereof
 FIG. 18 is a front view thereof
 FIG. 19 is a back view thereof
 FIG. 20 is a right side view thereof
 FIG. 21 is a left side view thereof
 FIG. 22 is a perspective view of an alternate embodiment of FIG. 1;
 FIG. 23 is a front view thereof
 FIG. 24 is a back view thereof
 FIG. 25 is a top view thereof
 FIG. 26 is a bottom view thereof
 FIG. 27 is a right side view thereof; and,
 FIG. 28 is a left side view thereof.

1 Claim, 4 Drawing Sheets

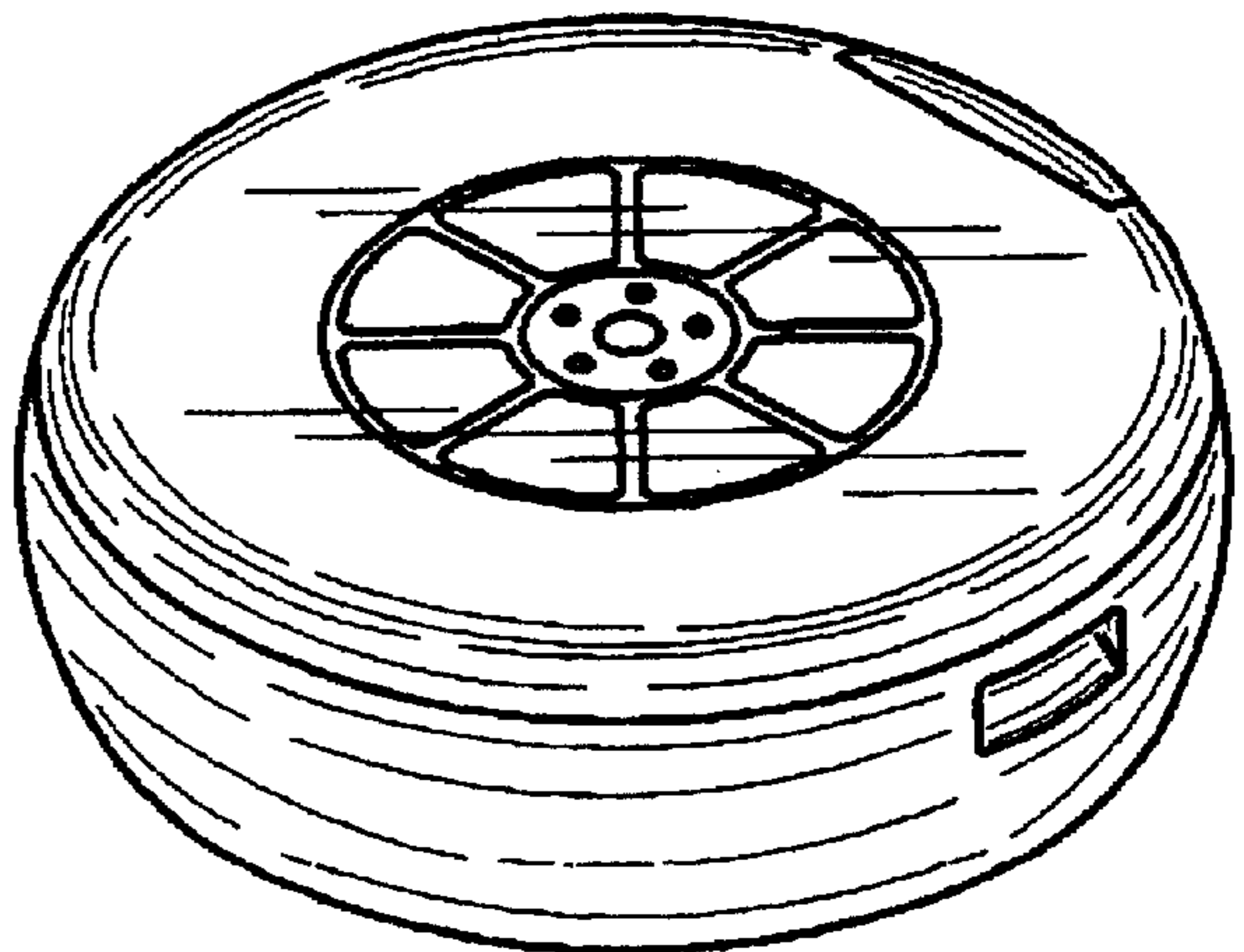
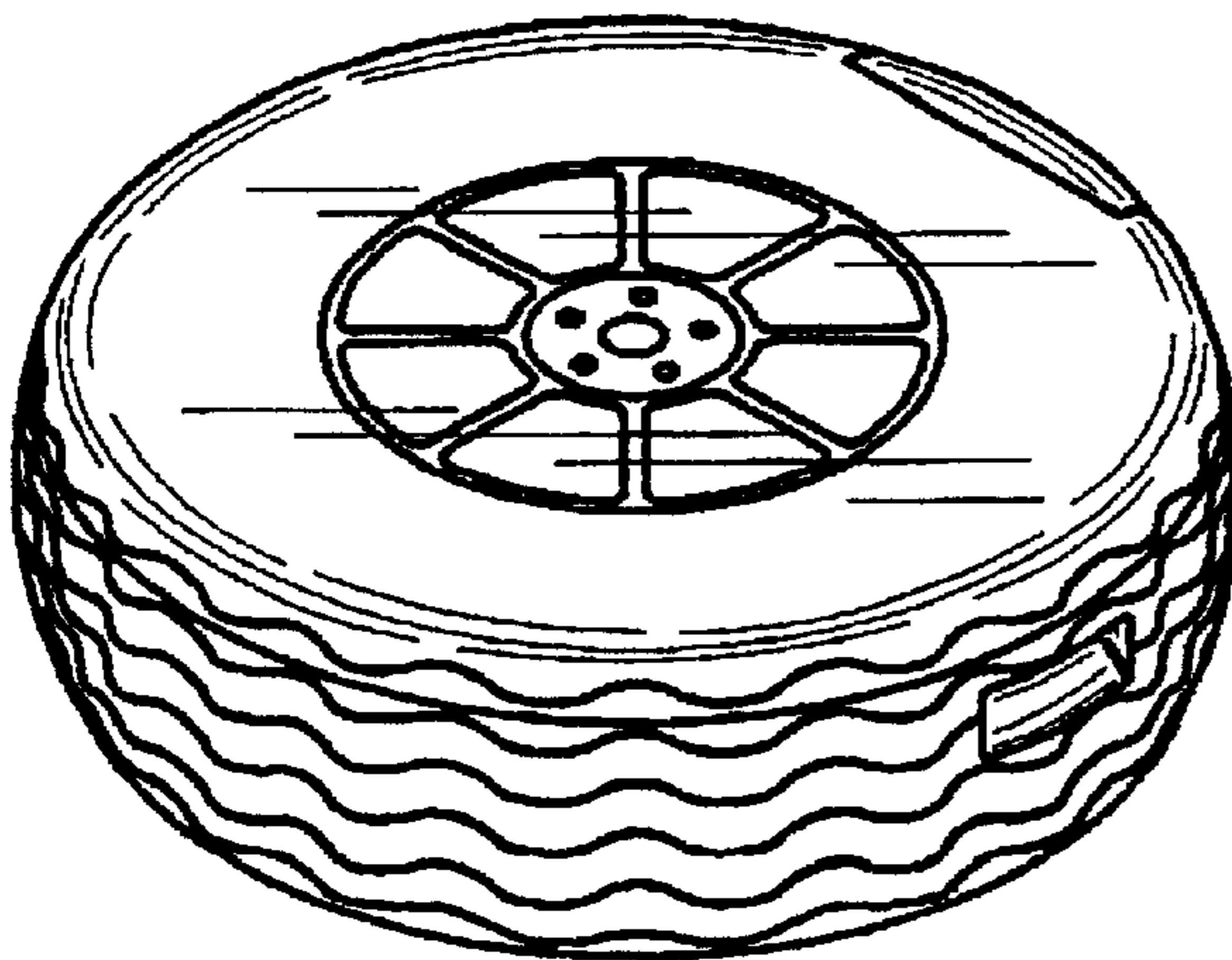

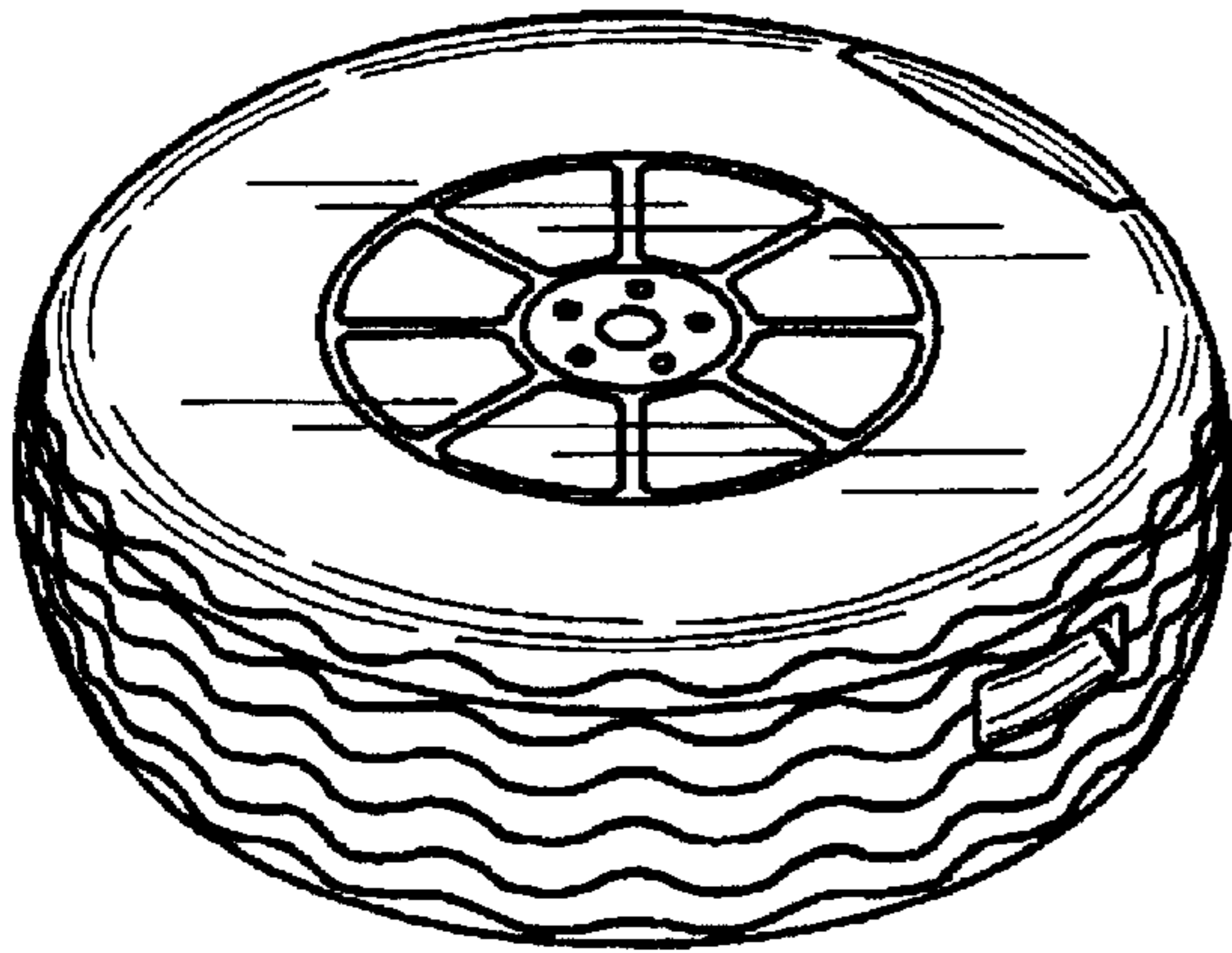

FIG. 1

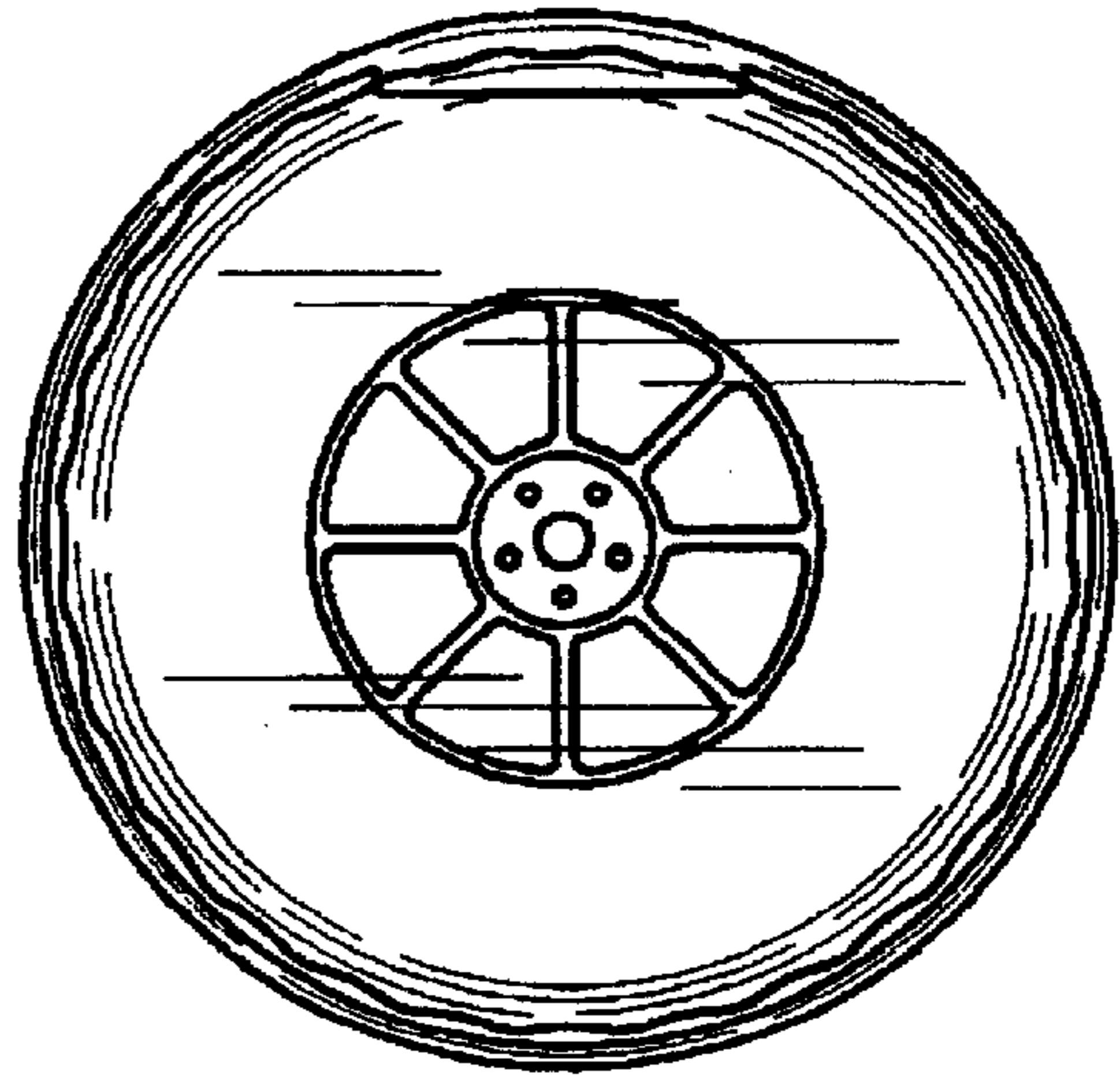

FIG. 2

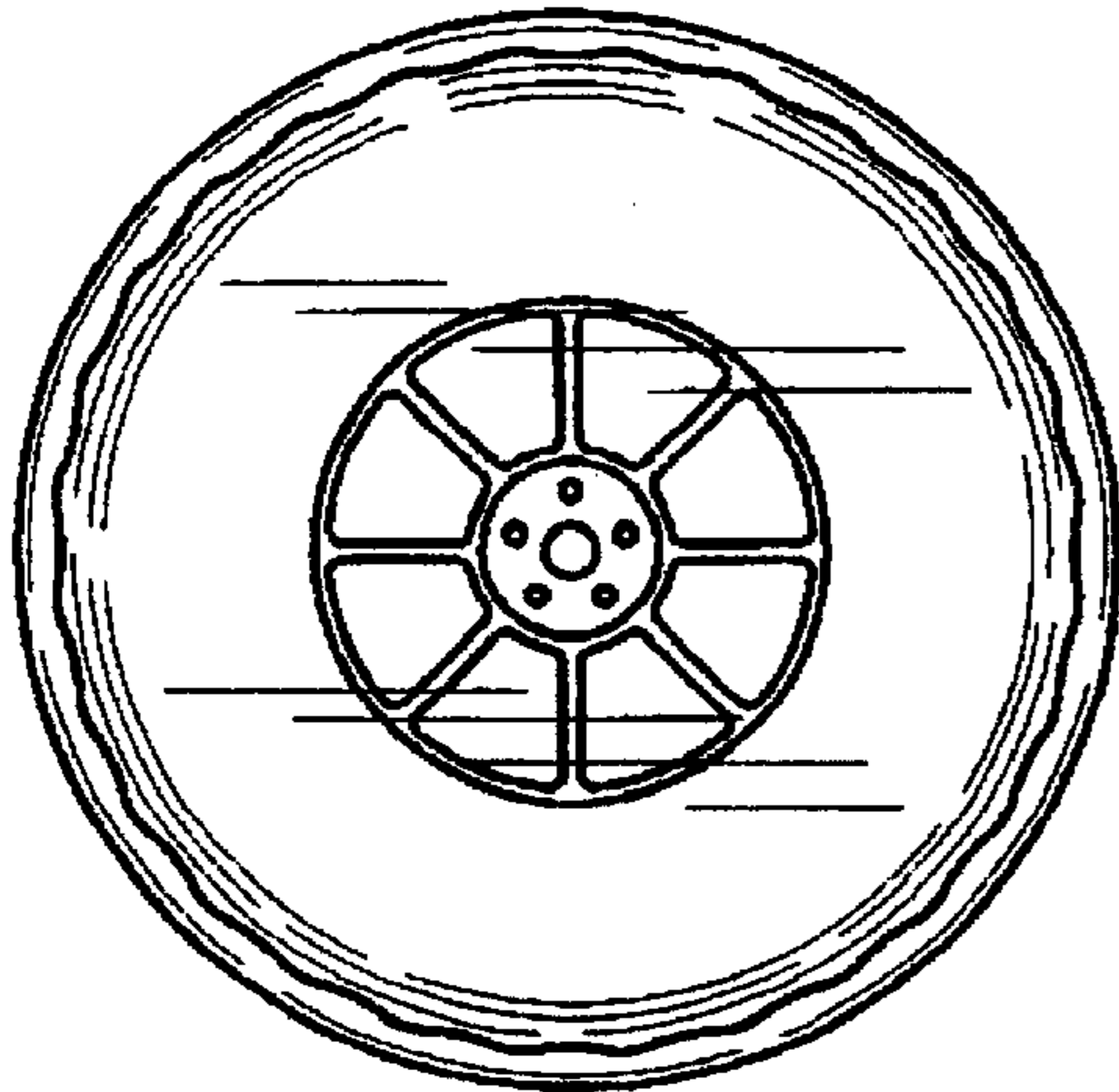

FIG. 3

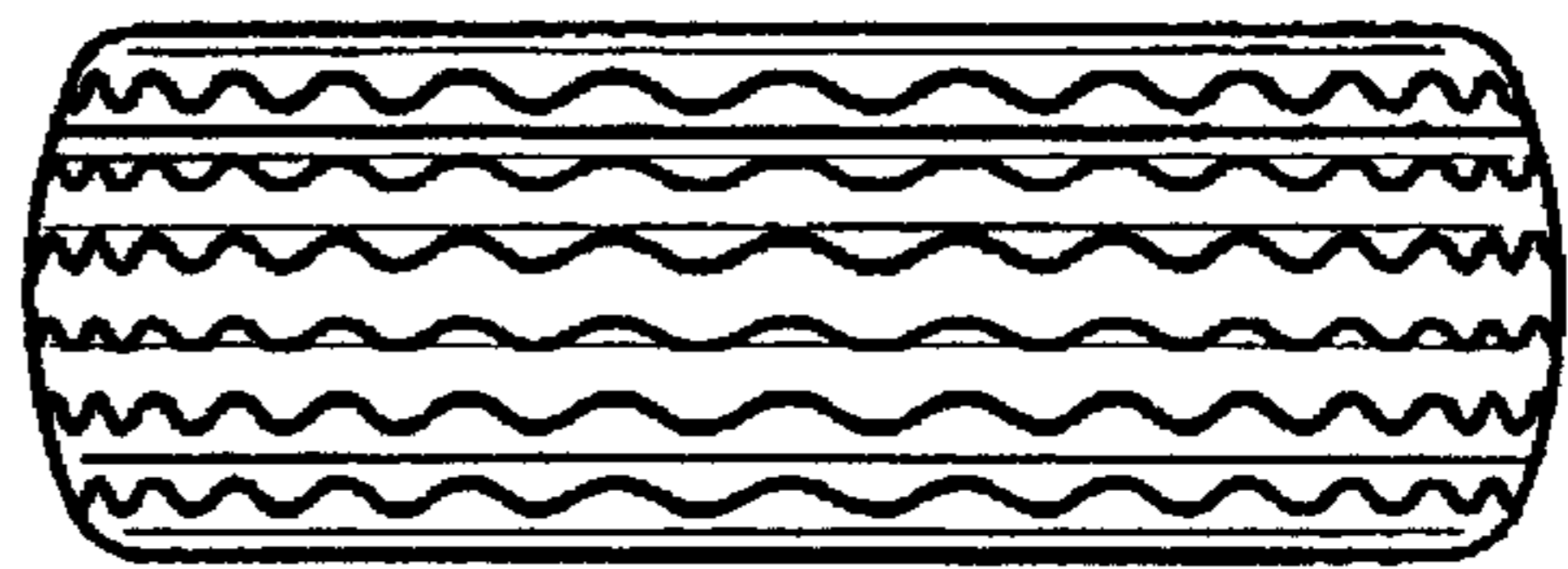

FIG. 4

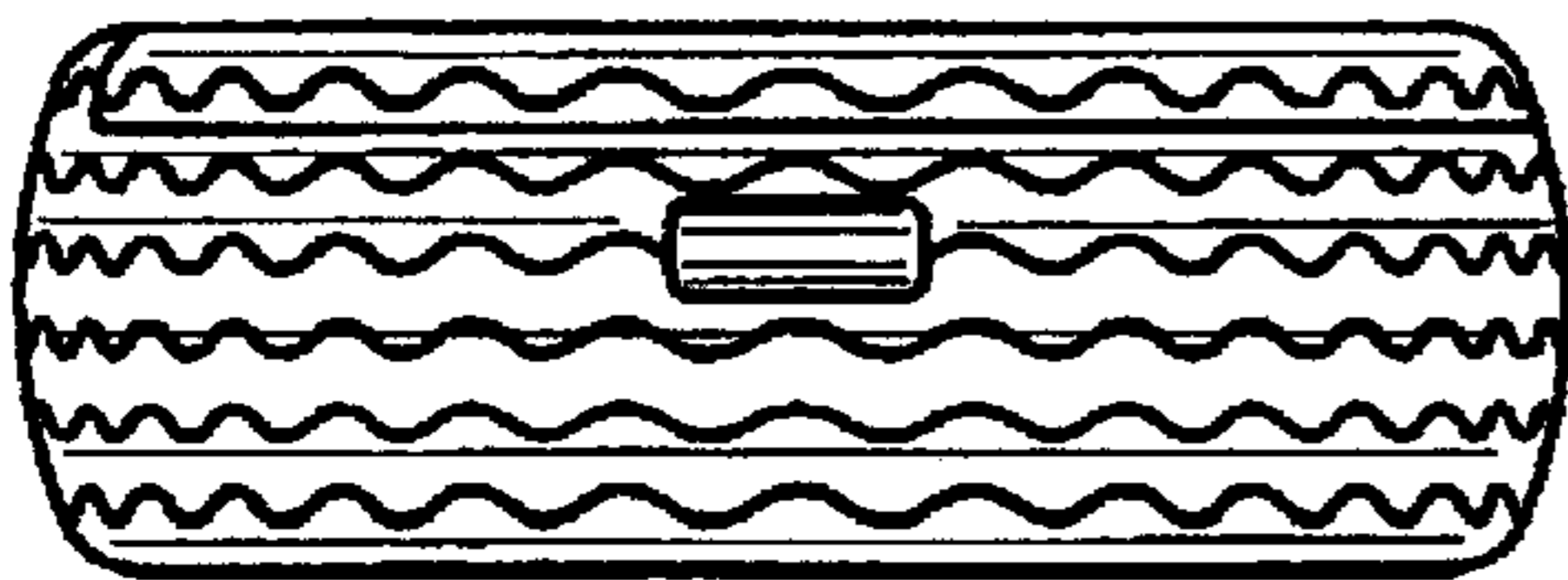

FIG. 6

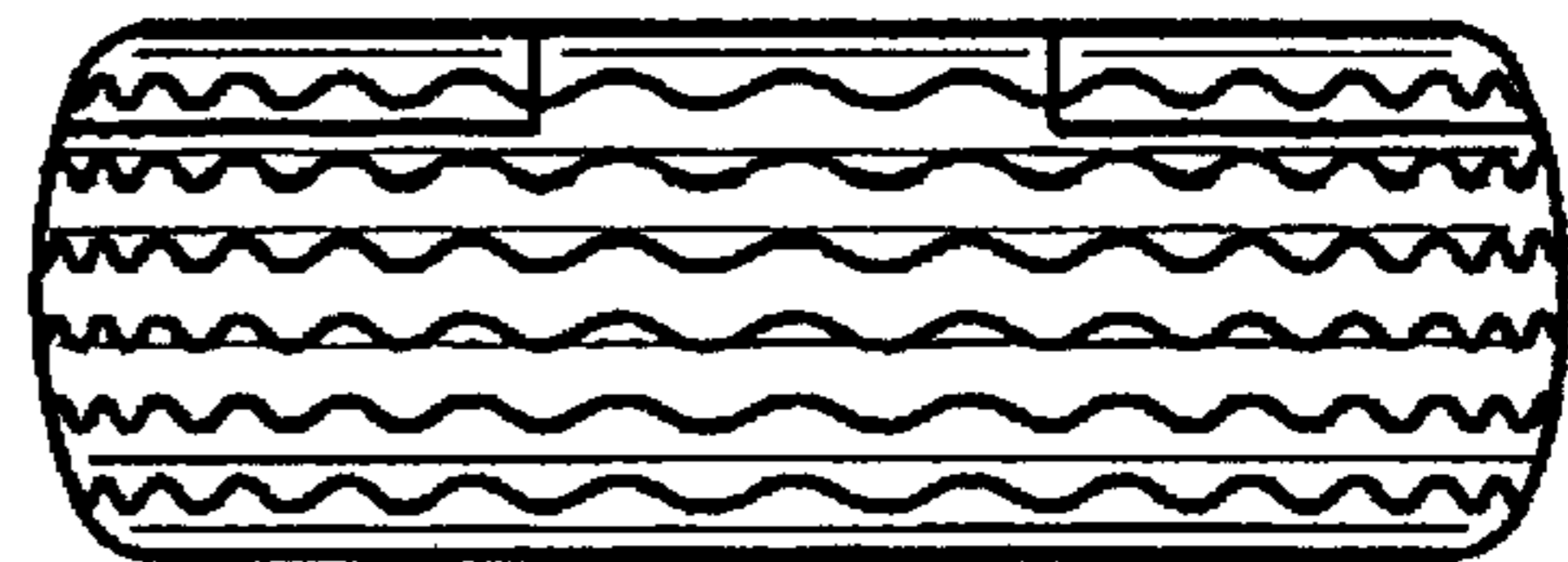
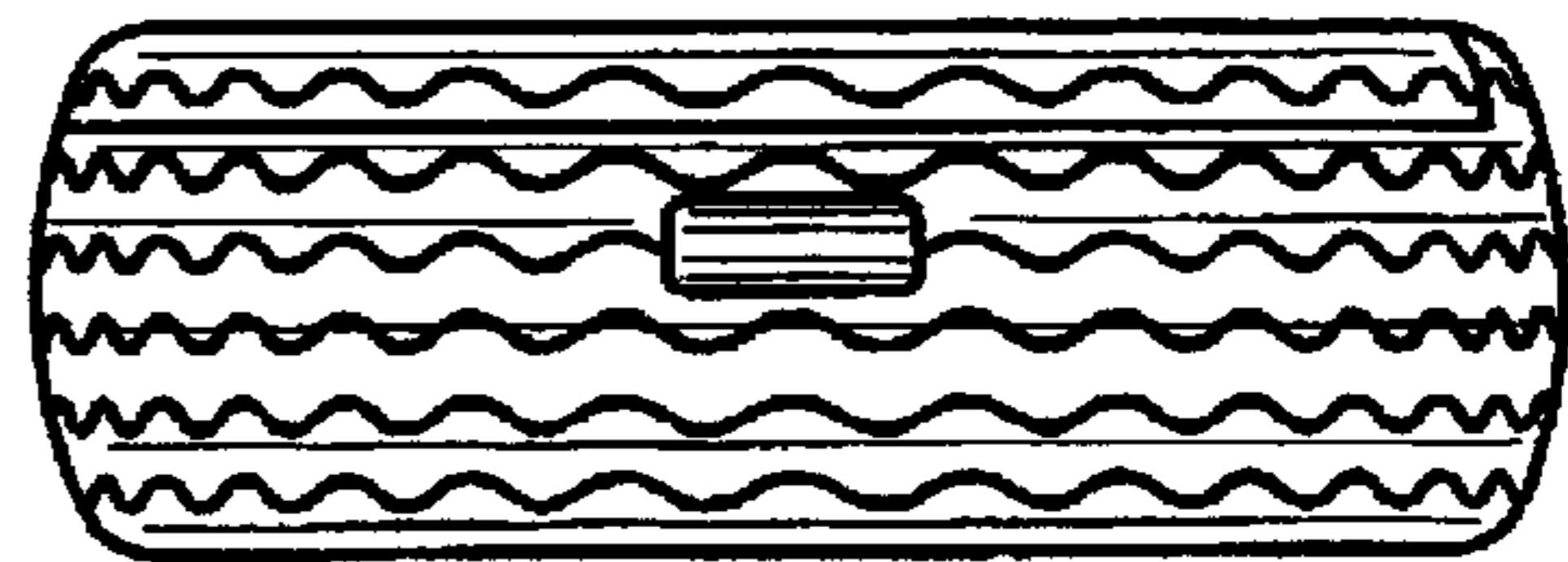

FIG. 5

FIG. 7



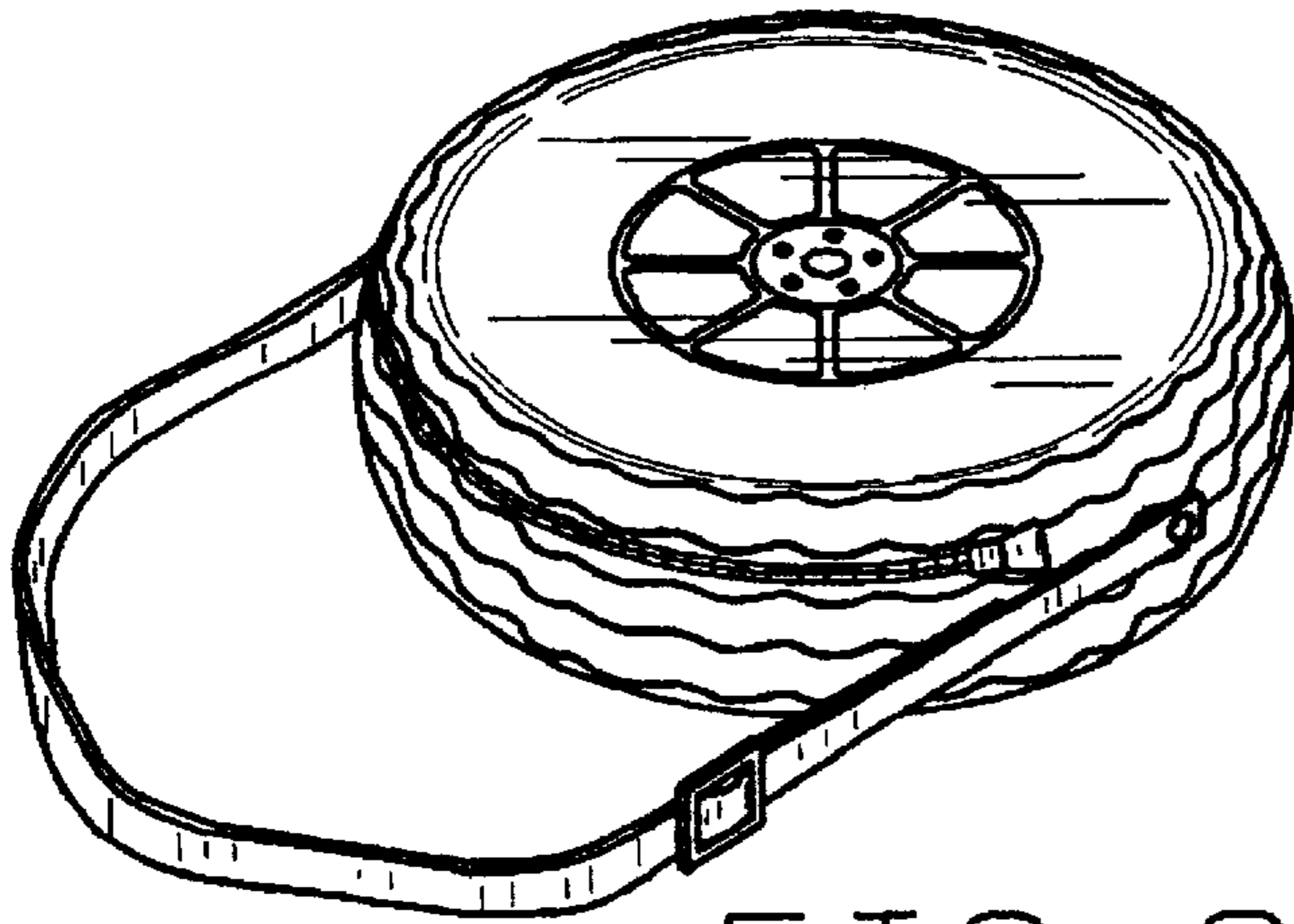

FIG. 8

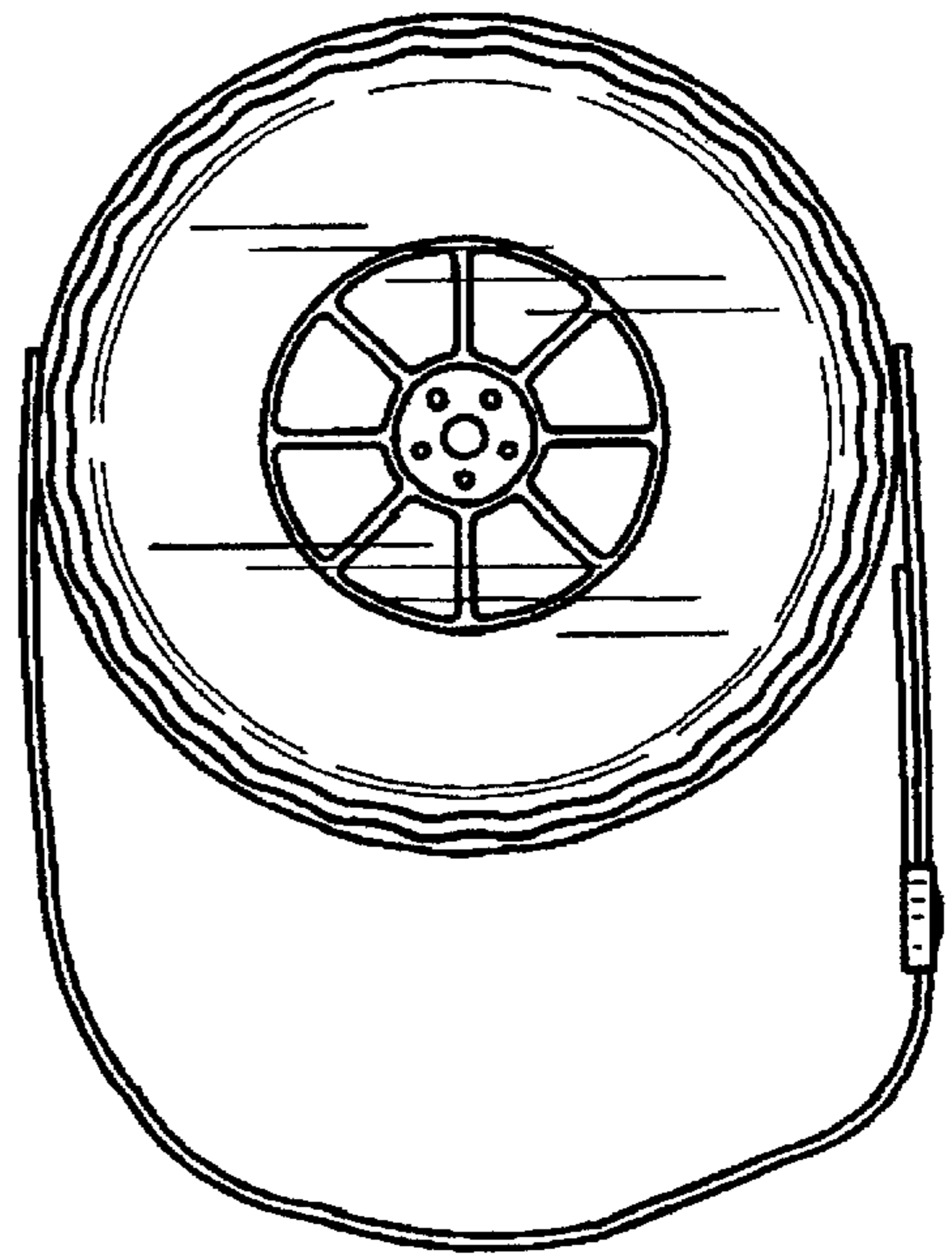

FIG. 9

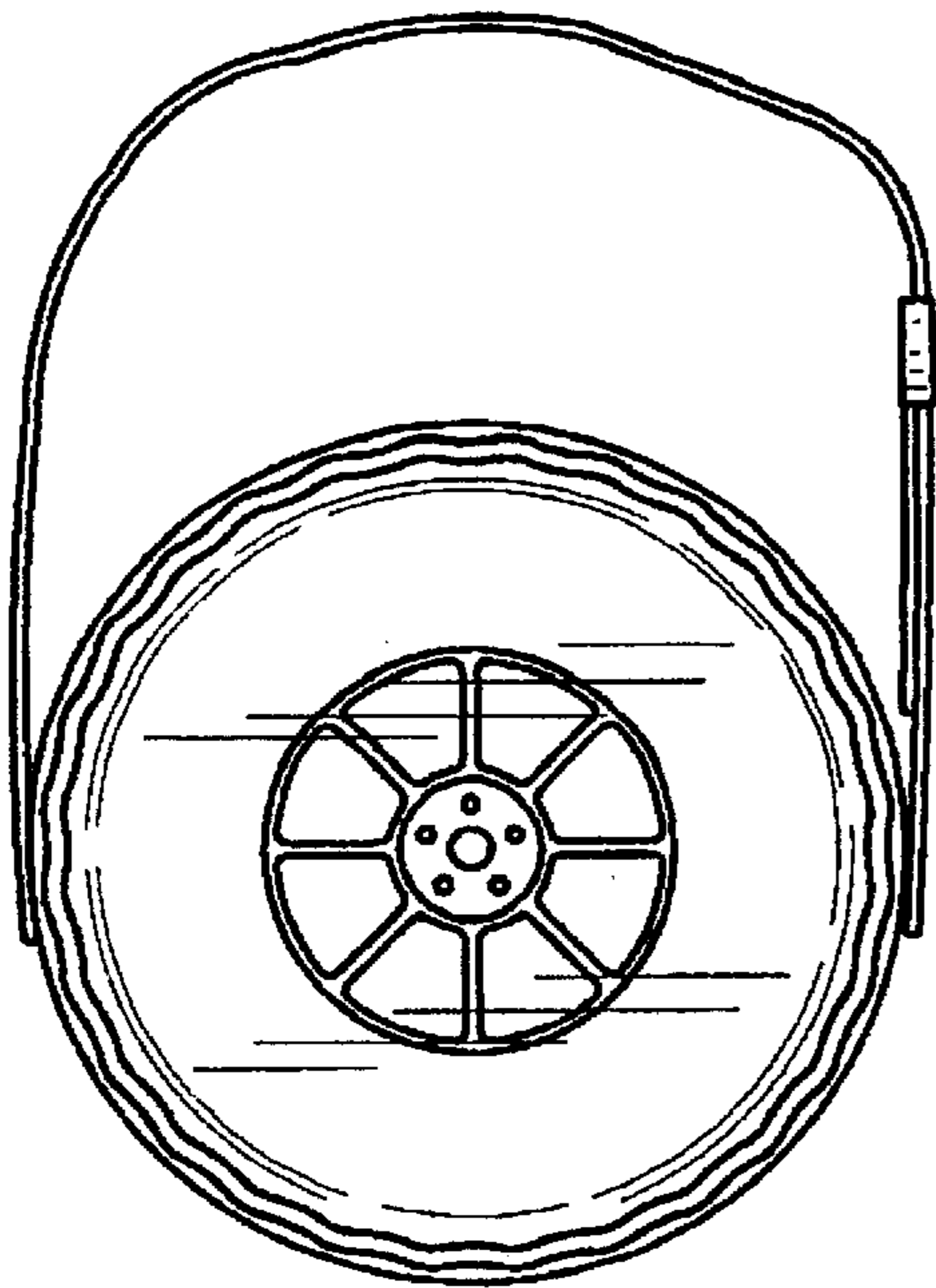

FIG. 10

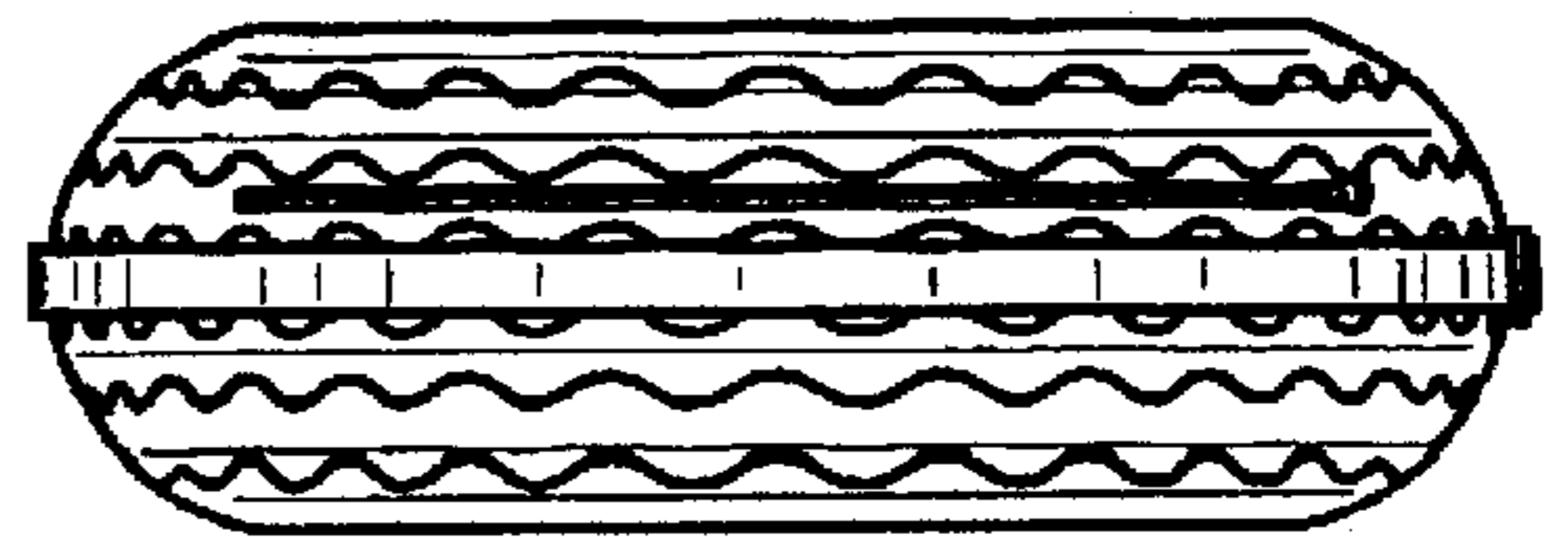

FIG. 11

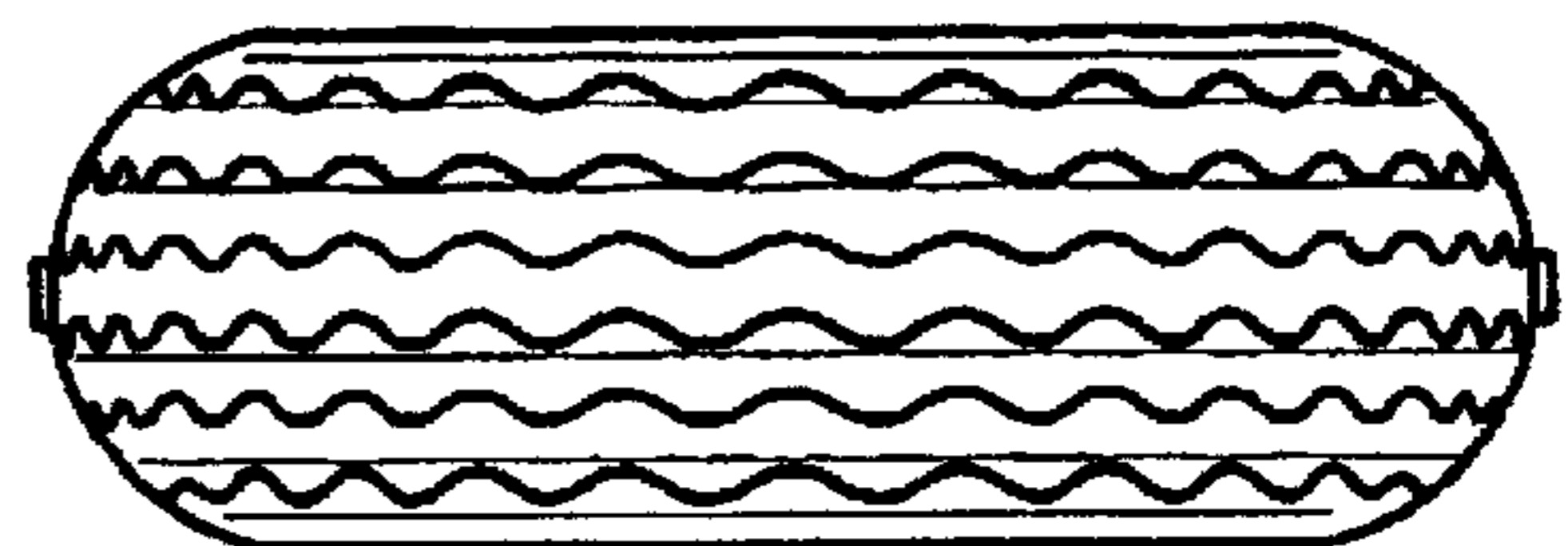

FIG. 12

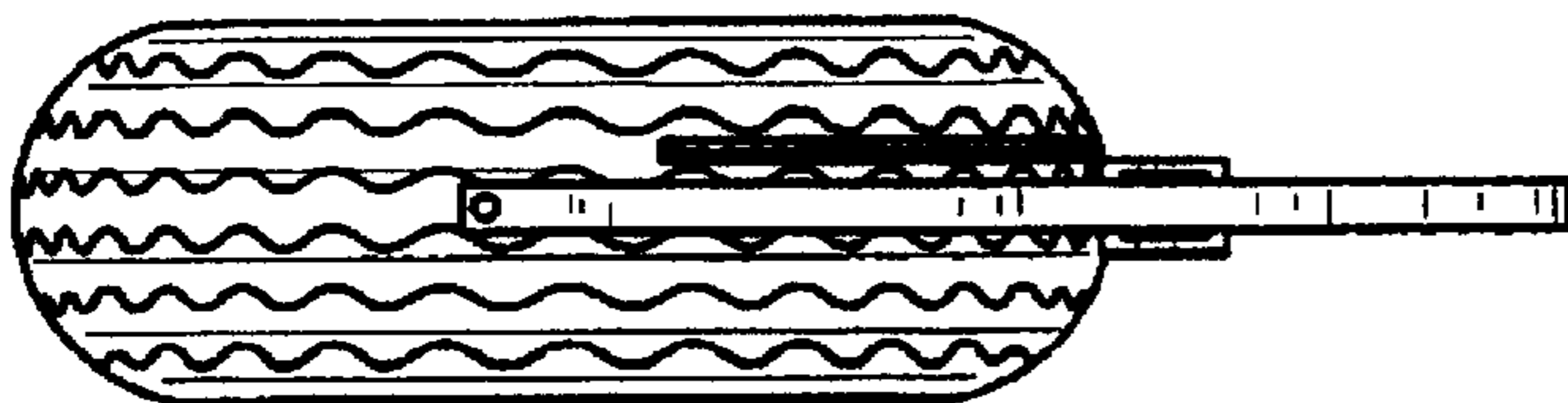

FIG. 13

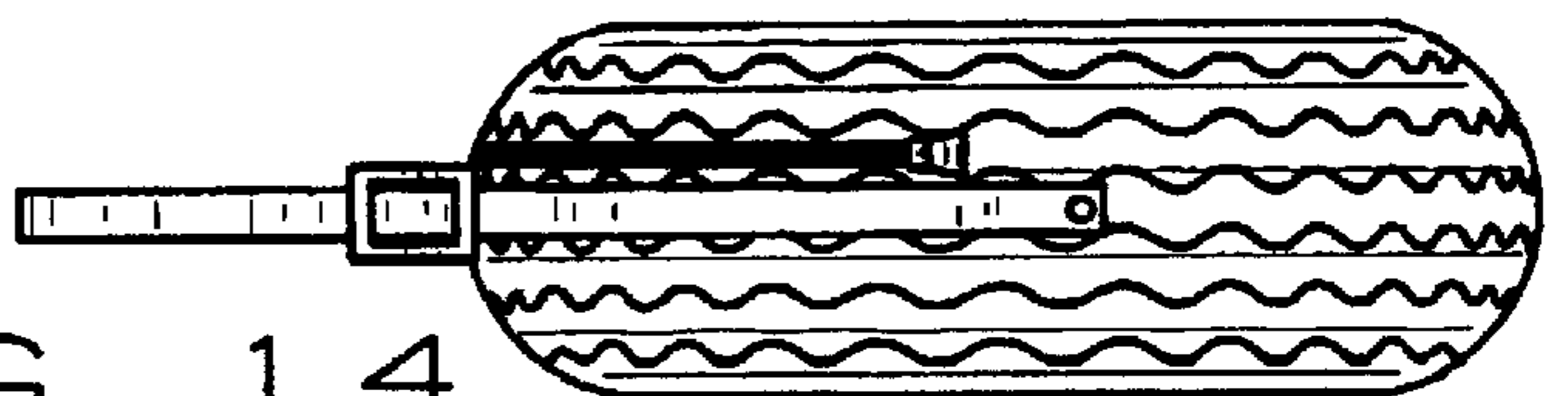

FIG. 14

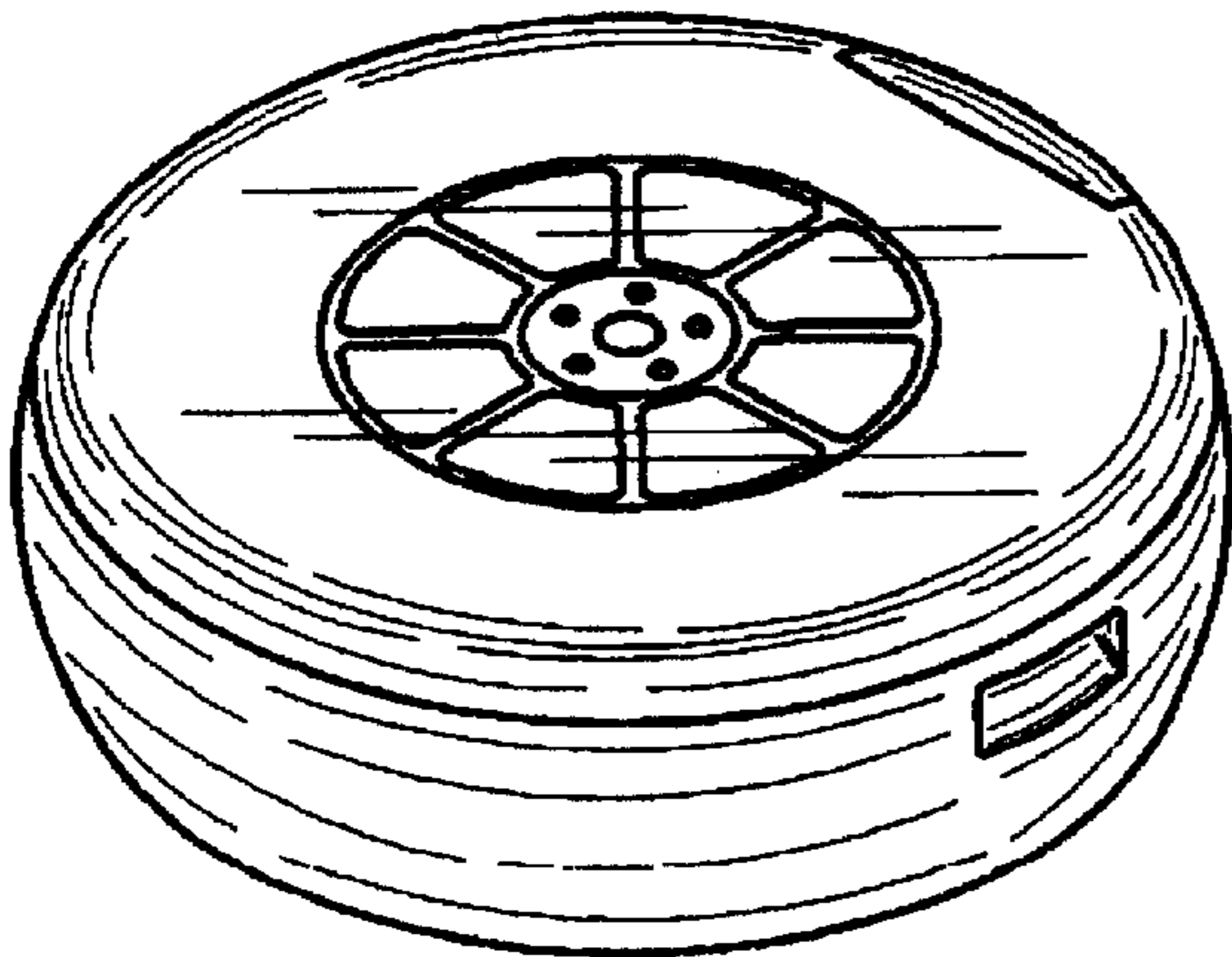

FIG. 15

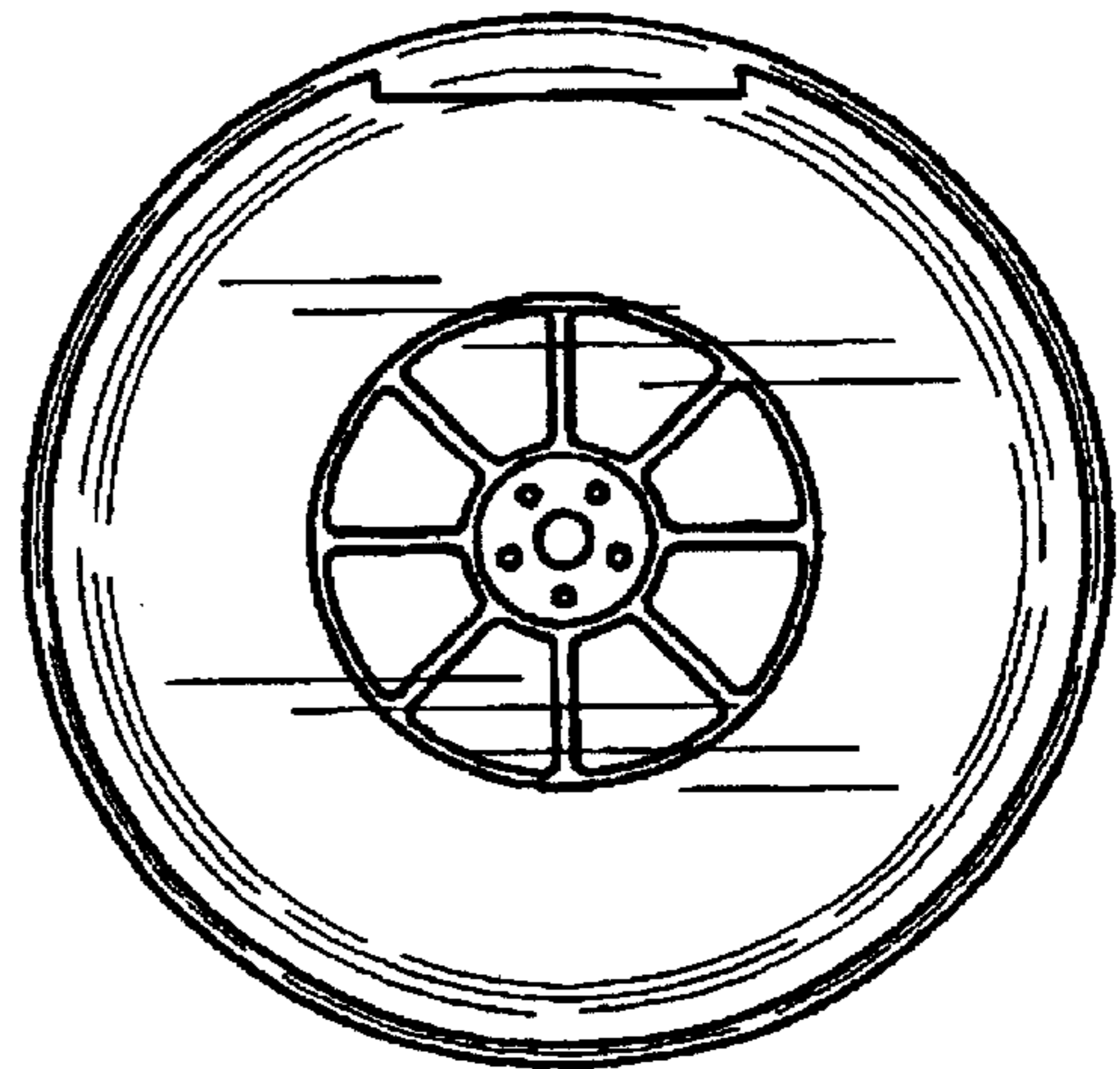

FIG. 16

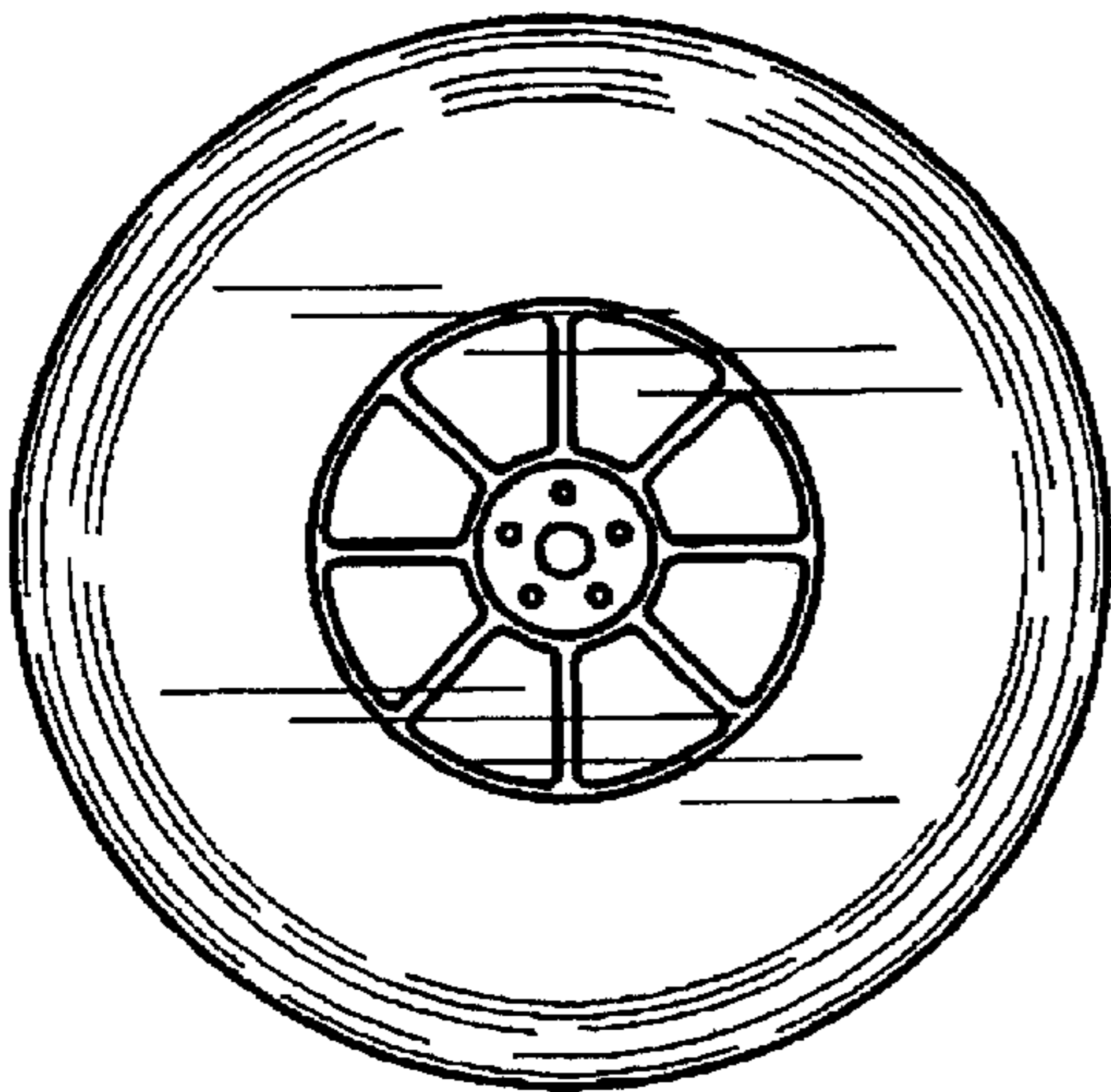

FIG. 17

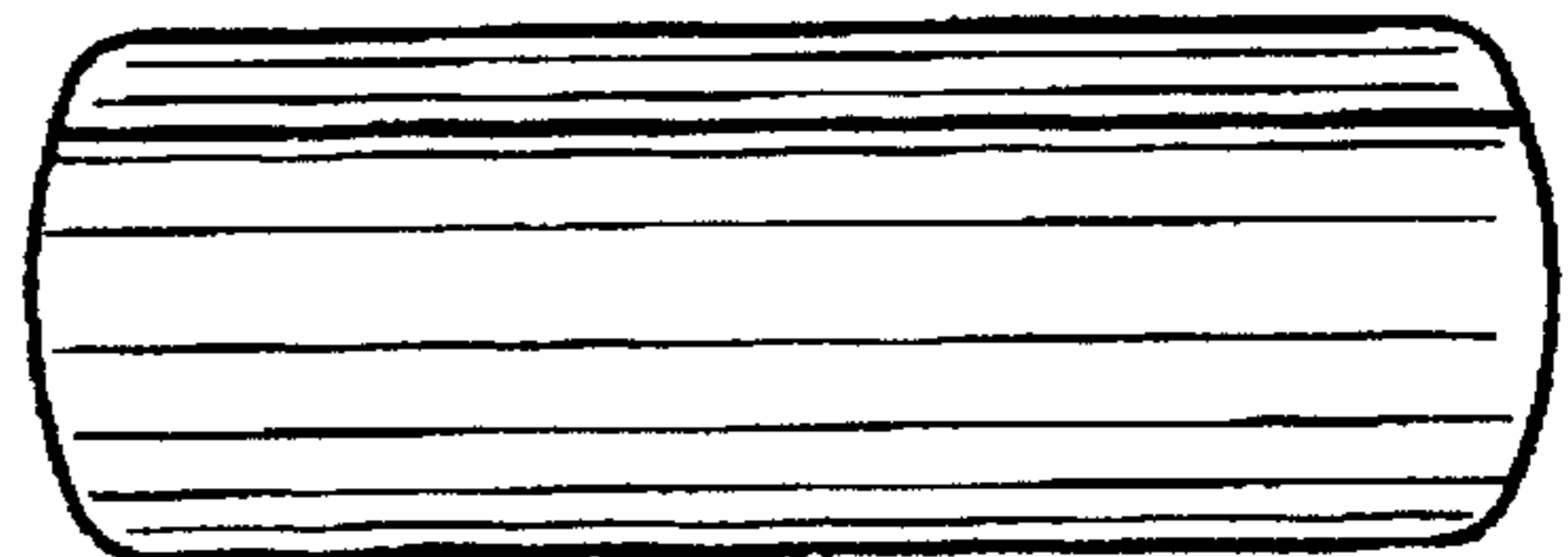

FIG. 18

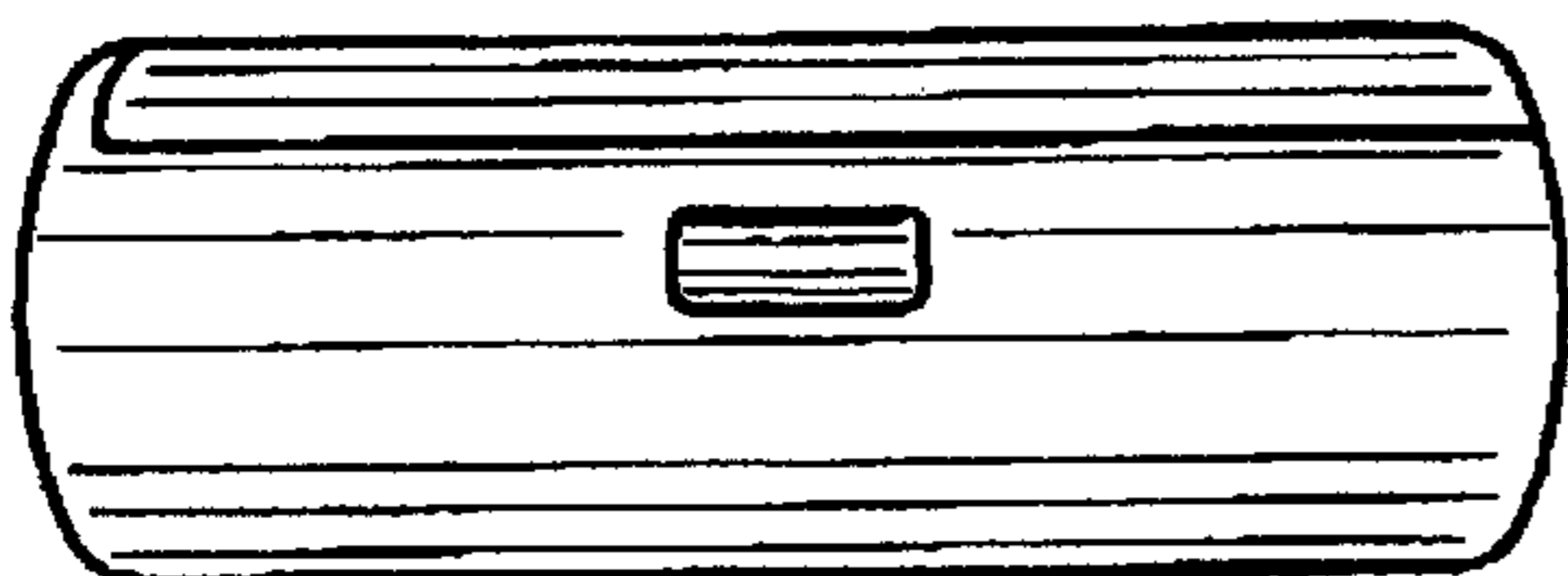

FIG. 20

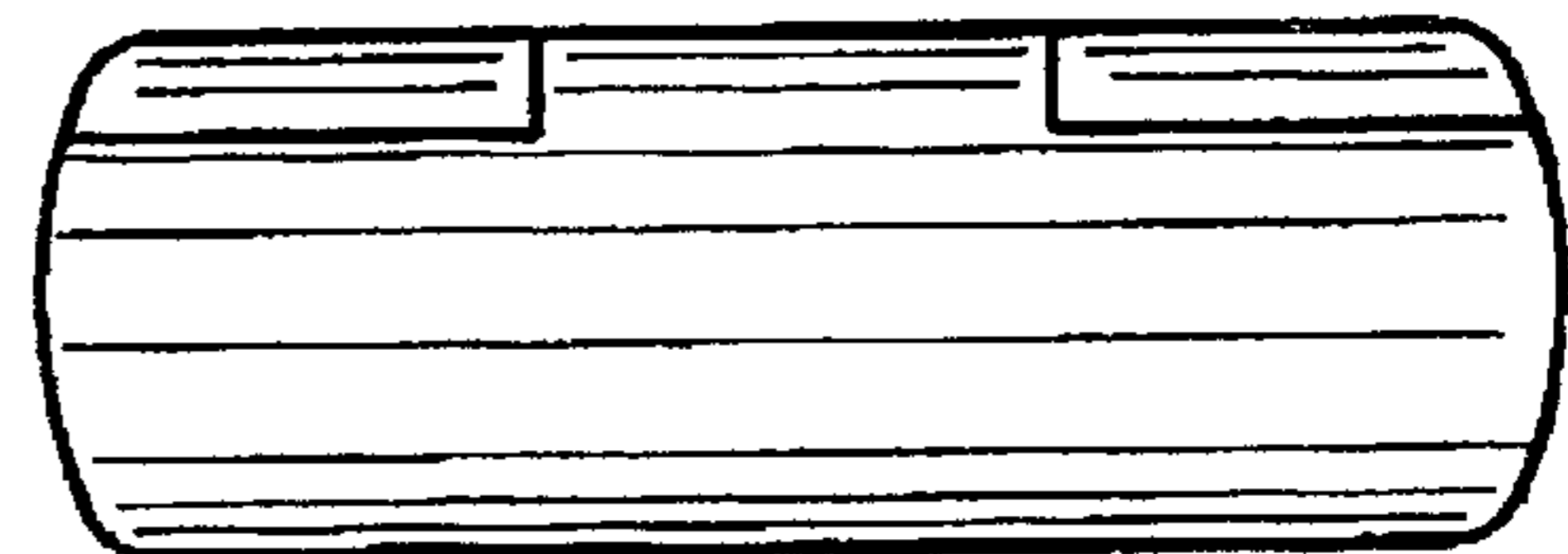
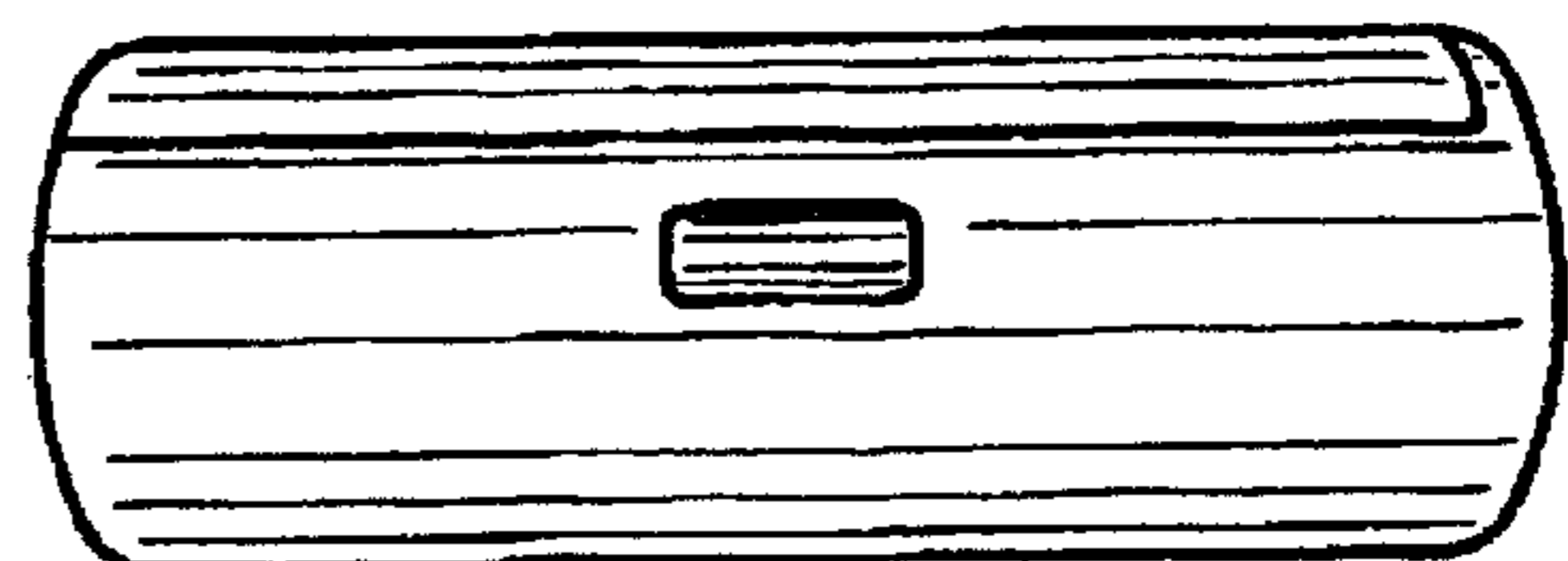

FIG. 19

FIG. 21



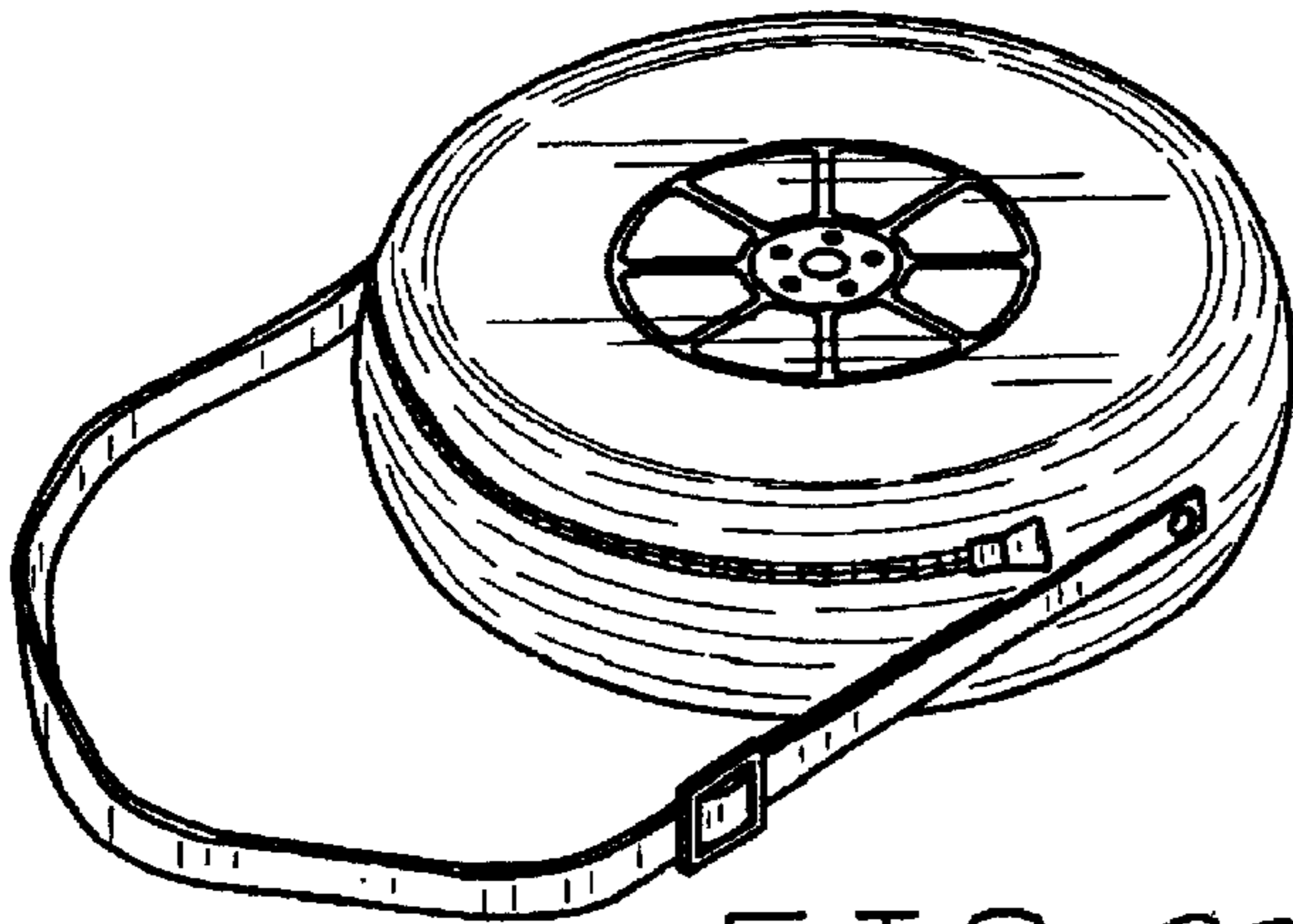

FIG. 22

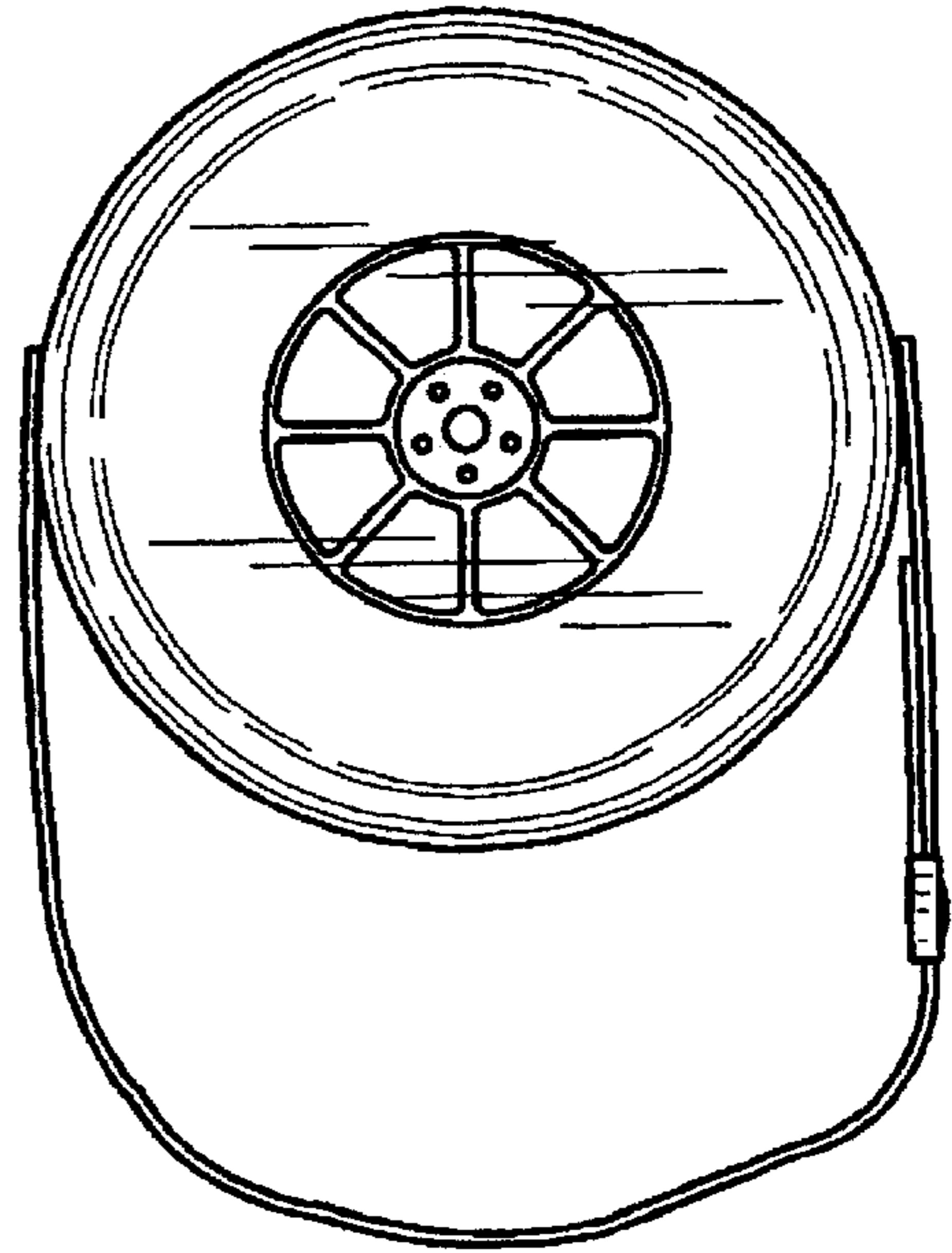

FIG. 23

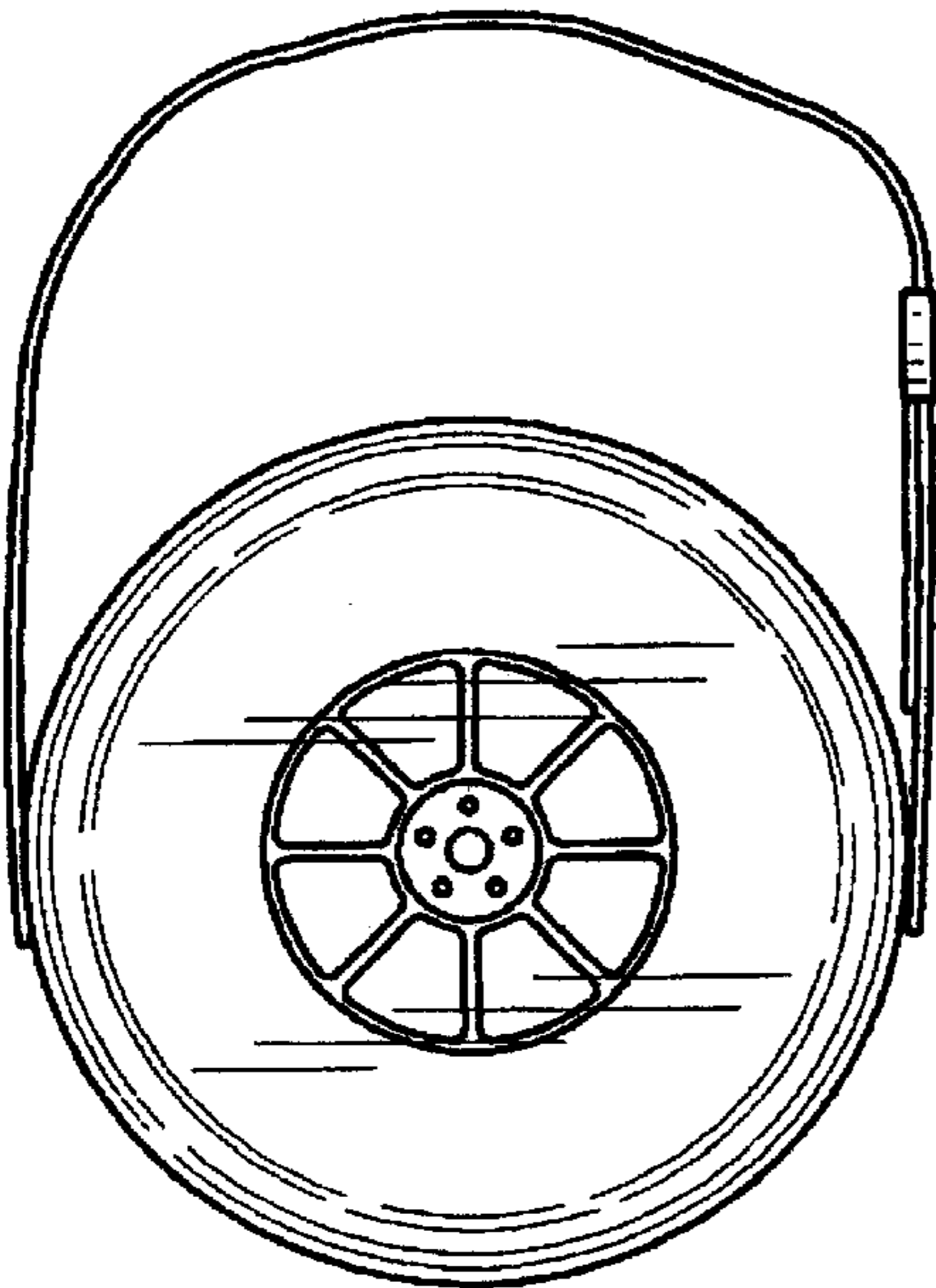

FIG. 24

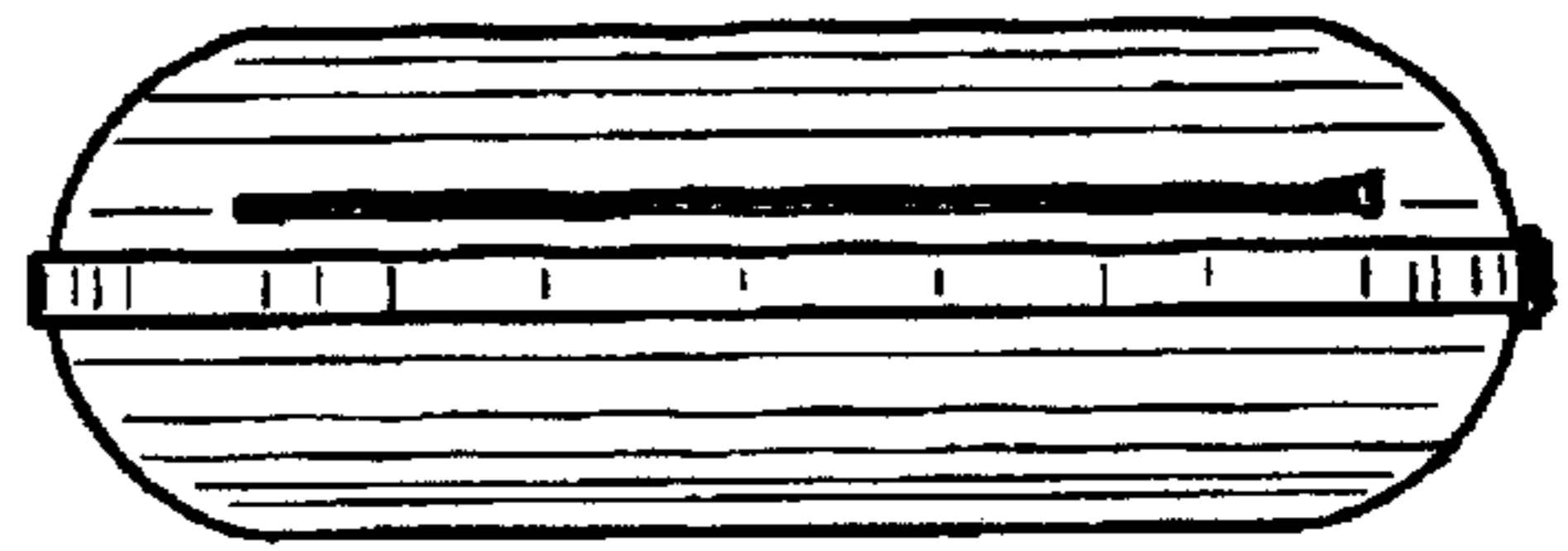

FIG. 25

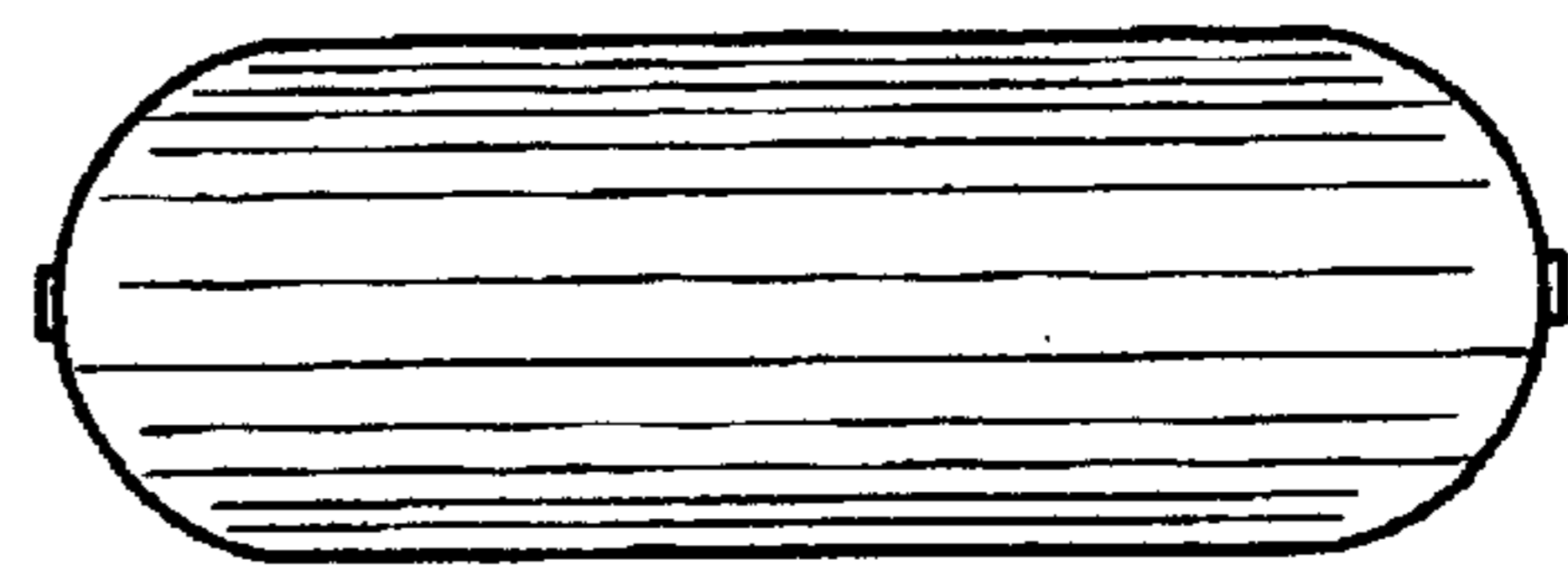

FIG. 26

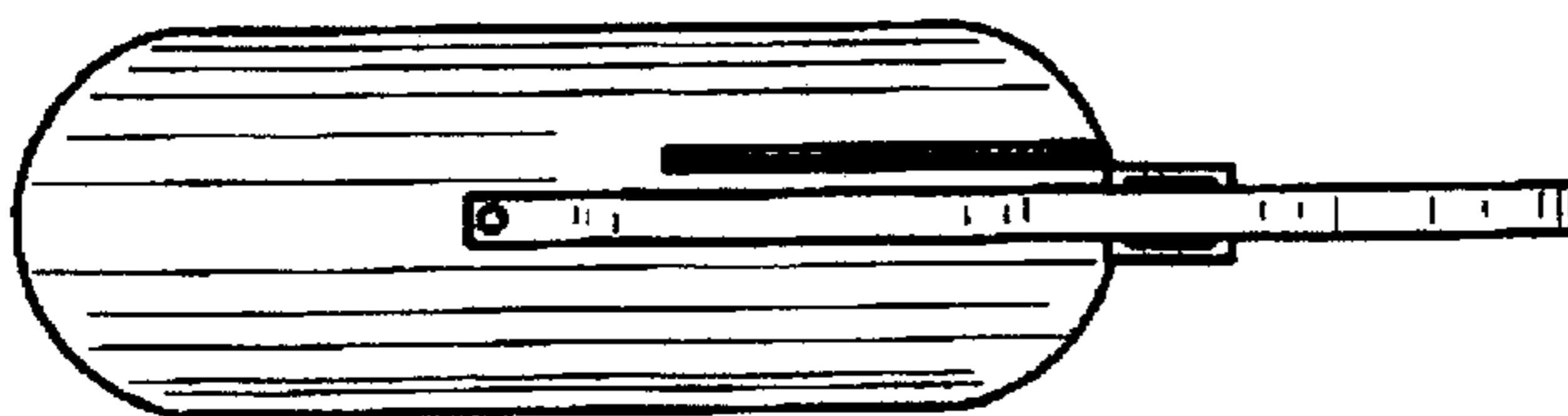

FIG. 27

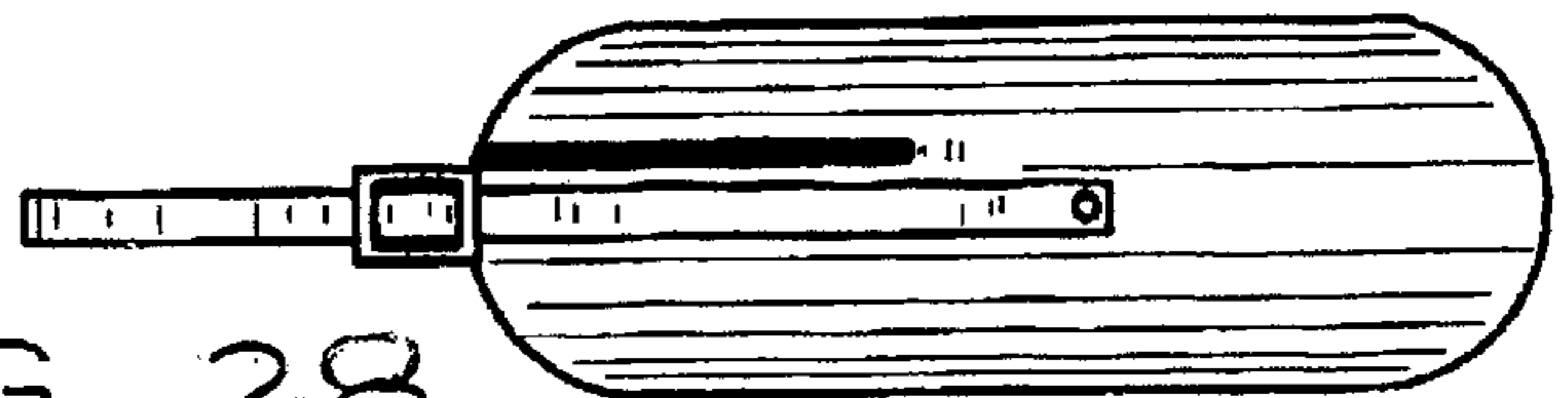

FIG. 28