



US00D448198B1

(12) **United States Design Patent**
Natuzzi et al.

(10) **Patent No.:** **US D448,198 S**

(45) **Date of Patent:** **** Sep. 25, 2001**

(54) **SEAT**

(75) Inventors: **Pasquale Natuzzi**, Bari; **Cosimo Suma**,
Matera, both of (IT)

(73) Assignee: **Industrie Natuzzi SpA**, Bari (IT)

(**) Term: **14 Years**

(21) Appl. No.: **29/120,124**

(22) Filed: **Mar. 14, 2000**

(51) **LOC (7) Cl.** **06-01**

(52) **U.S. Cl.** **D6/381; D6/334**

(58) **Field of Search** D6/334, 335, 336,
D6/364, 371, 381, 500, 501, 502; 5/12.1;
297/232, 445.1

Natuzzi Model 829, Apr. 1991, at International Home Furnishings Market in High Point, North Carolina.
Natuzzi Model 839, Apr. 1991, at International Home Furnishings Market in High Point, North Carolina.
Natuzzi Model 842, Apr. 1991, at International Home Furnishings Market in High Point, North Carolina.
Natuzzi Model 863, Oct. 1991, at International Home Furnishings Market in High Point, North Carolina.
Natuzzi Model 866, Oct. 1991, at International Home Furnishings Market in High Point, North Carolina.
Natuzzi Model 871, Oct. 1991, at International Home Furnishings Market in High Point, North Carolina.
Natuzzi Model 882, Oct. 1991, at International Home Furnishings Market in High Point, North Carolina.

(List continued on next page.)

Primary Examiner—Gary D. Watson

(74) *Attorney, Agent, or Firm*—Alston & Bird LLP

(56) **References Cited**

U.S. PATENT DOCUMENTS

D. 376,925	*	12/1996	Paus	D6/381
D. 379,036	*	5/1997	Natuzzi et al.	D6/381
D. 380,622	*	7/1997	Chandler	D6/381
D. 388,260	*	12/1997	Natuzzi et al.	D6/381
D. 388,261	*	12/1997	Natuzzi et al.	D6/381
D. 388,970	*	1/1998	Natuzzi et al.	D6/381
D. 399,363	*	10/1998	Natuzzi et al.	D6/381
D. 407,574	*	4/1999	Natuzzi et al.	D6/381
D. 418,992	*	1/2000	Natuzzi et al.	D6/381
D. 419,794	*	2/2000	Natuzzi et al.	D6/381
D. 428,556	*	7/2000	Natuzzi et al.	D6/381
D. 438,722	*	3/2001	Natuzzi et al.	D6/381

OTHER PUBLICATIONS

Natuzzi: Model 1299, International Home Furnishings Market, High Point, NC, Apr. 1995.*

Natuzzi Model 653, Oct. 1989, at International Home Furnishings Market in High Point, North Carolina.

Natuzzi Model 745, Apr. 1990, at International Home Furnishings Market in High Point, North Carolina.

Natuzzi Model 783, Oct. 1990, at International Home Furnishings Market in High Point, North Carolina.

Natuzzi Model 787, Oct. 1990, at International Home Furnishings Market in High Point, North Carolina.

(57) **CLAIM**

The ornamental design for a seat, as shown and described.

DESCRIPTION

FIG. 1 is a front perspective view of a seat showing our new design in the form of a sofa;

FIG. 2 is a front elevational view thereof;

FIG. 3 is a top plan view thereof;

FIG. 4 is a right side elevational view, the left side being a mirror image thereof;

FIG. 5 is a rear elevational view thereof;

FIG. 6 is a front elevational view of a seat showing our new design in the form of a loveseat; and,

FIG. 7 is a front elevational view of a seat showing our new design in the form of a chair.

The broken lines shown herein are for illustrative purposes only and form no part of the claimed design.

The rear views of FIGS. 6 and 7 are like FIG. 5, the difference being a matter of length.

The end views of FIGS. 6 and 7 are like FIG. 4.

FIG. 1 is shown on an enlarged scale with respect to the other views.

1 Claim, 3 Drawing Sheets

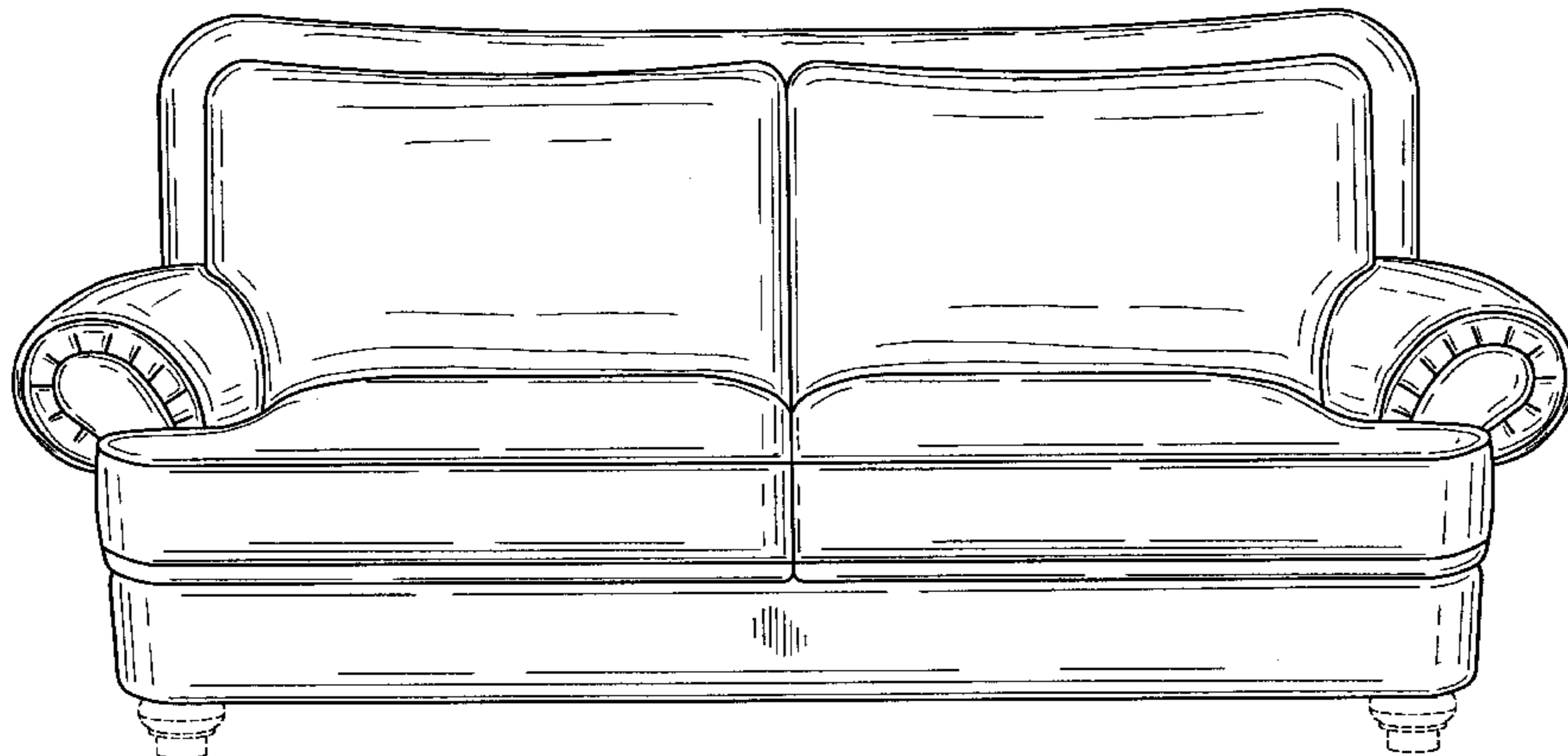

OTHER PUBLICATIONS

Natuzzi Model 897, Oct. 1991, at International Home Furnishings Market in High Point, North Carolina.

Natuzzi Model 903, Apr. 1992, at International Home Furnishings Market in High Point, North Carolina.

Natuzzi Model 967, Oct. 1992, at International Home Furnishings Market in High Point, North Carolina.

Natuzzi Model 1043, Apr. 1993, at International Home Furnishings Market in High Point, North Carolina.

Natuzzi Model 1141, Apr. 1994, at International Home Furnishings Market in High Point, North Carolina.

Natuzzi Model 1183, Apr. 1994, at International Home Furnishings Market in High Point, North Carolina.

Natuzzi Model 1190, Apr. 1994, at International Home Furnishings Market in High Point, North Carolina.

Natuzzi Model 1224, Oct. 1994, at International Home Furnishings Market in High Point, North Carolina.

Natuzzi Model 1293, Mar. 1995, at International Home Furnishings Market in High Point, North Carolina.

Natuzzi Model 1346, Sep. 1995, at International Home Furnishings Market in High Point, North Carolina.

Natuzzi Model 1431, Mar. 1996, at International Home Furnishings Market in High Point, North Carolina.

Natuzzi Model 1433, Mar. 1996, at International Home Furnishings Market in High Point, North Carolina.

Natuzzi Model 1434, Mar. 1996, at International Home Furnishings Market in High Point, North Carolina.

Natuzzi Model 1522, Oct. 1996, at International Home Furnishings Market in High Point, North Carolina.

Natuzzi Model 1633, Oct. 1997, at International Home Furnishings Market in High Point, North Carolina.

Natuzzi Model 1695, Apr. 1998, at International Home Furnishings Market in High Point, North Carolina.

* cited by examiner

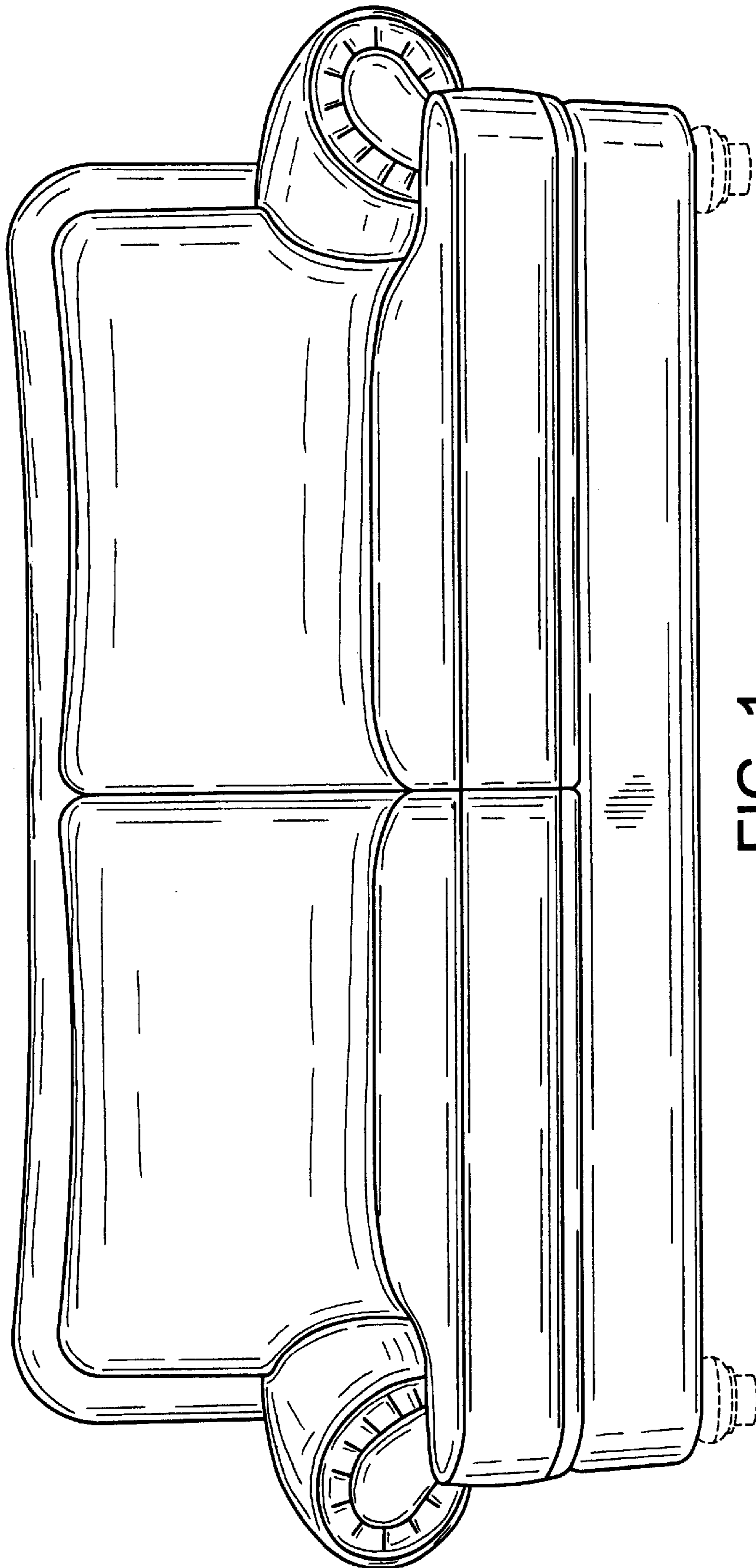

FIG. 1.

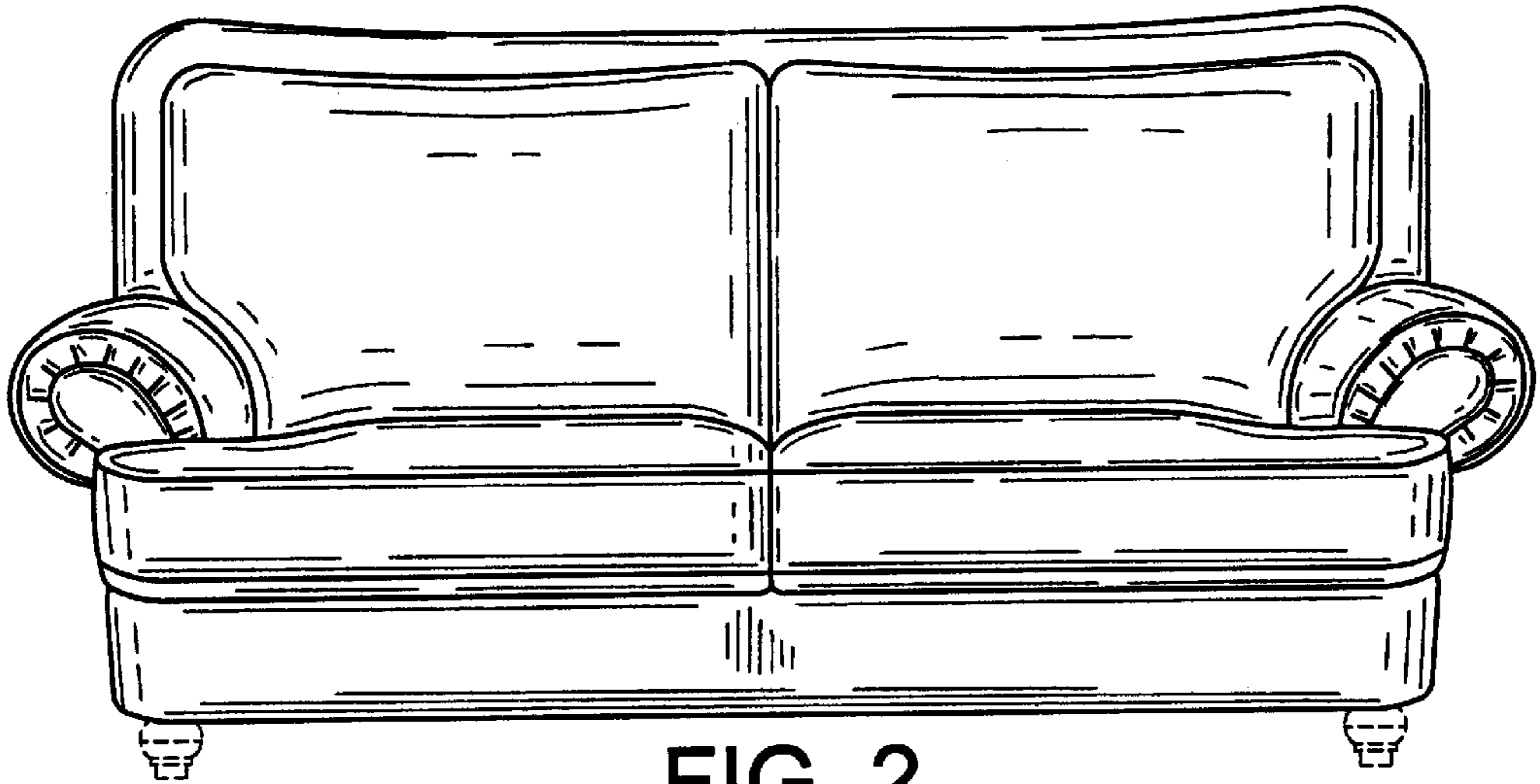

FIG. 2.

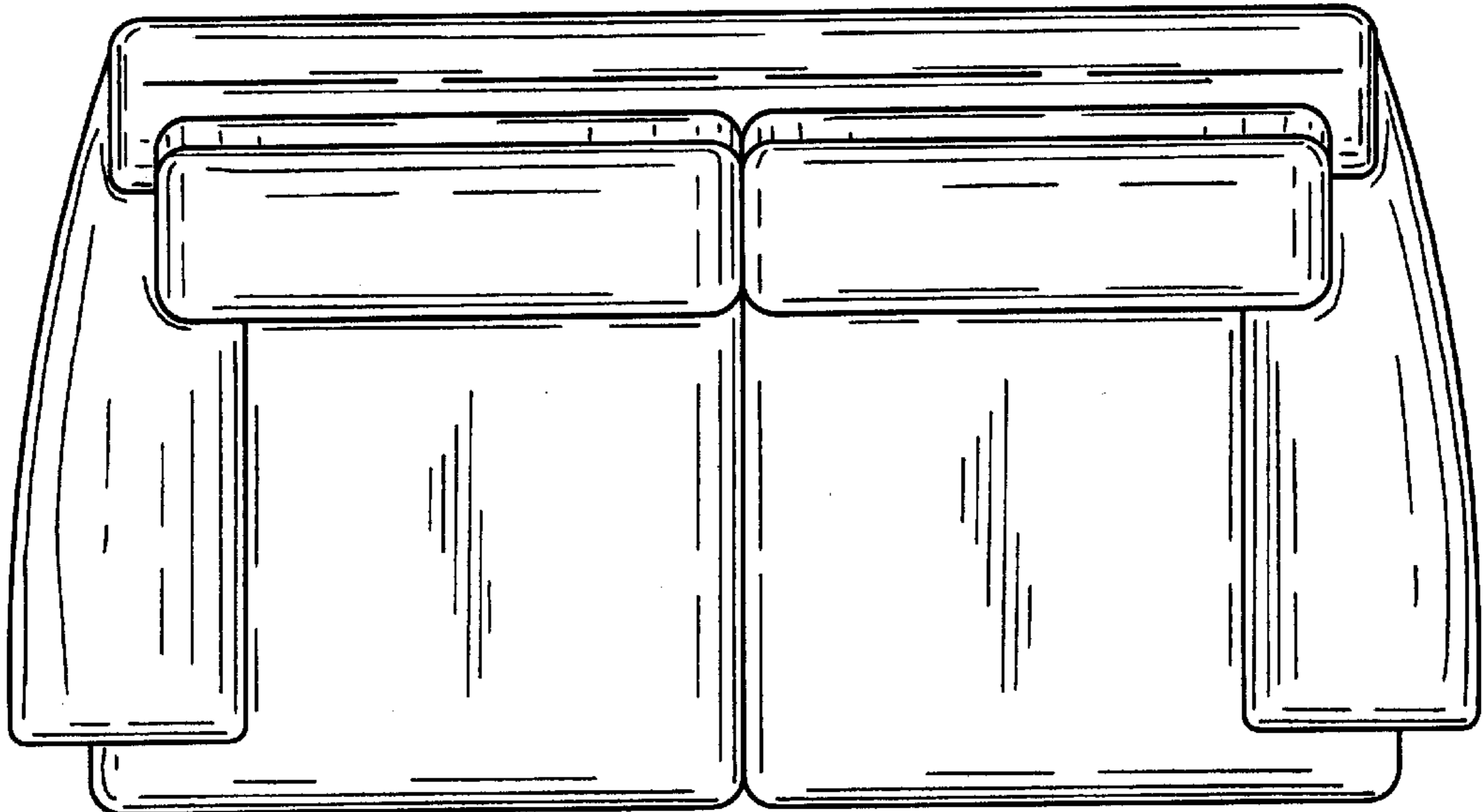

FIG. 3.

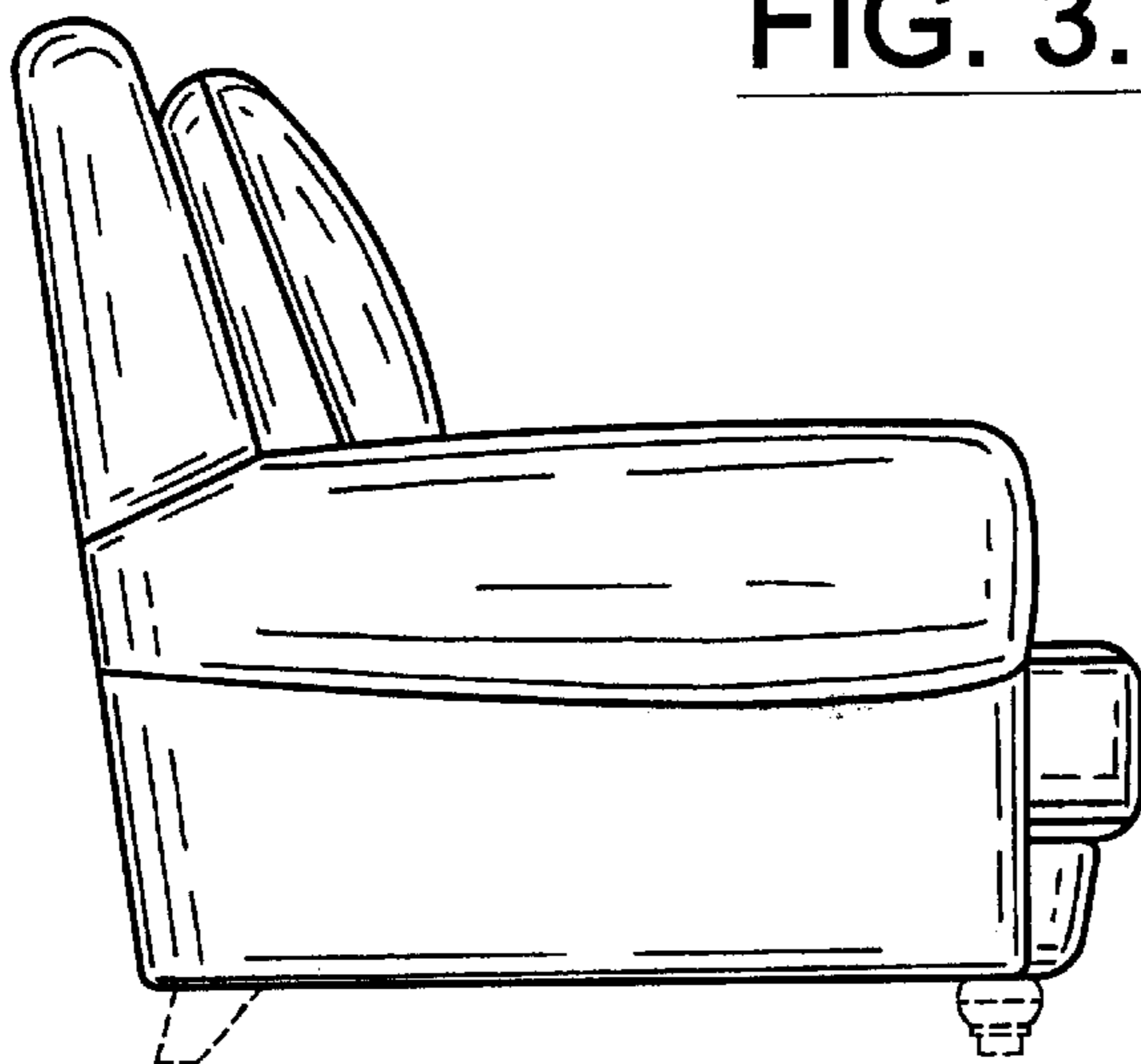

FIG. 4.

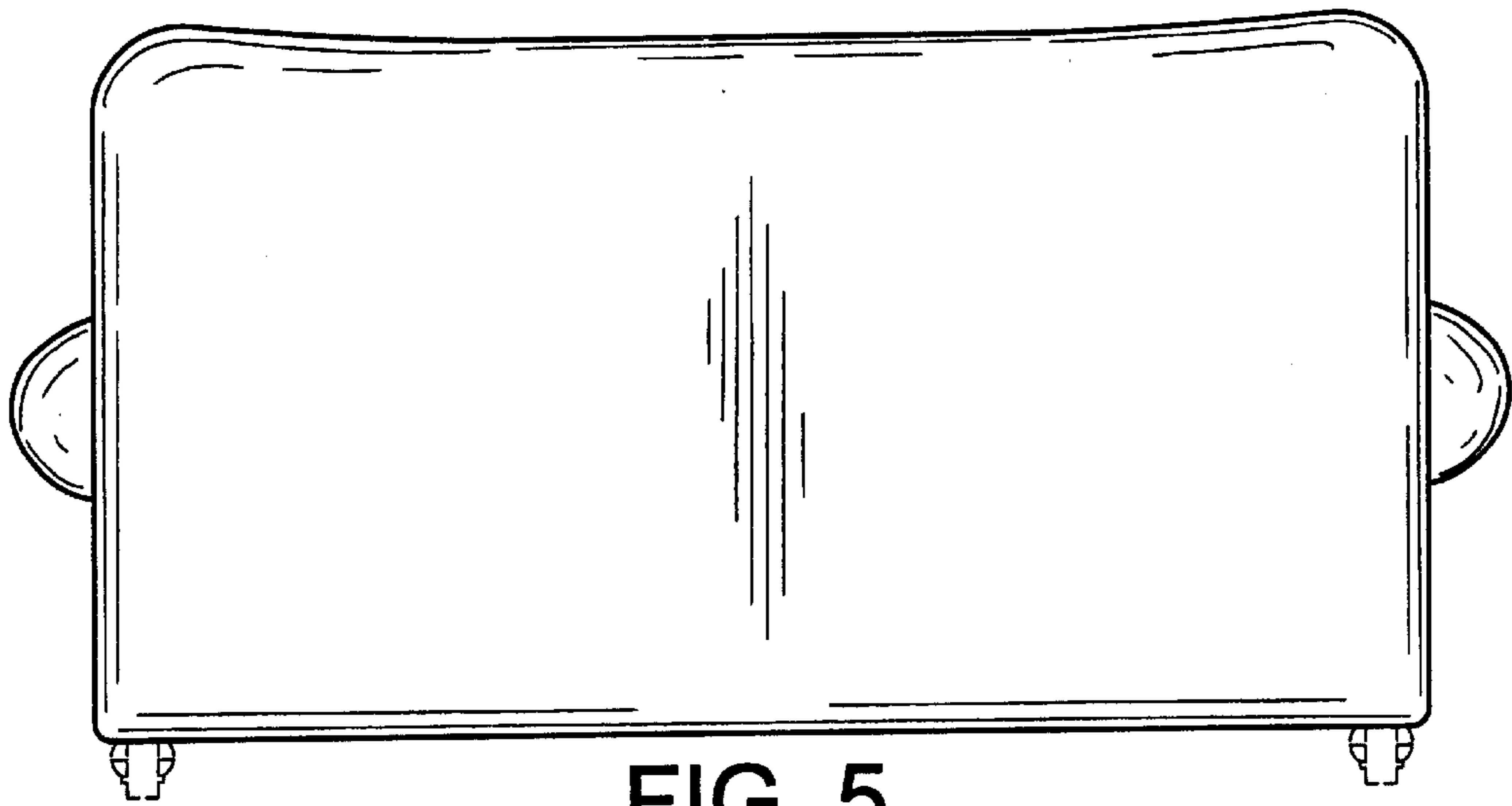

FIG. 5.

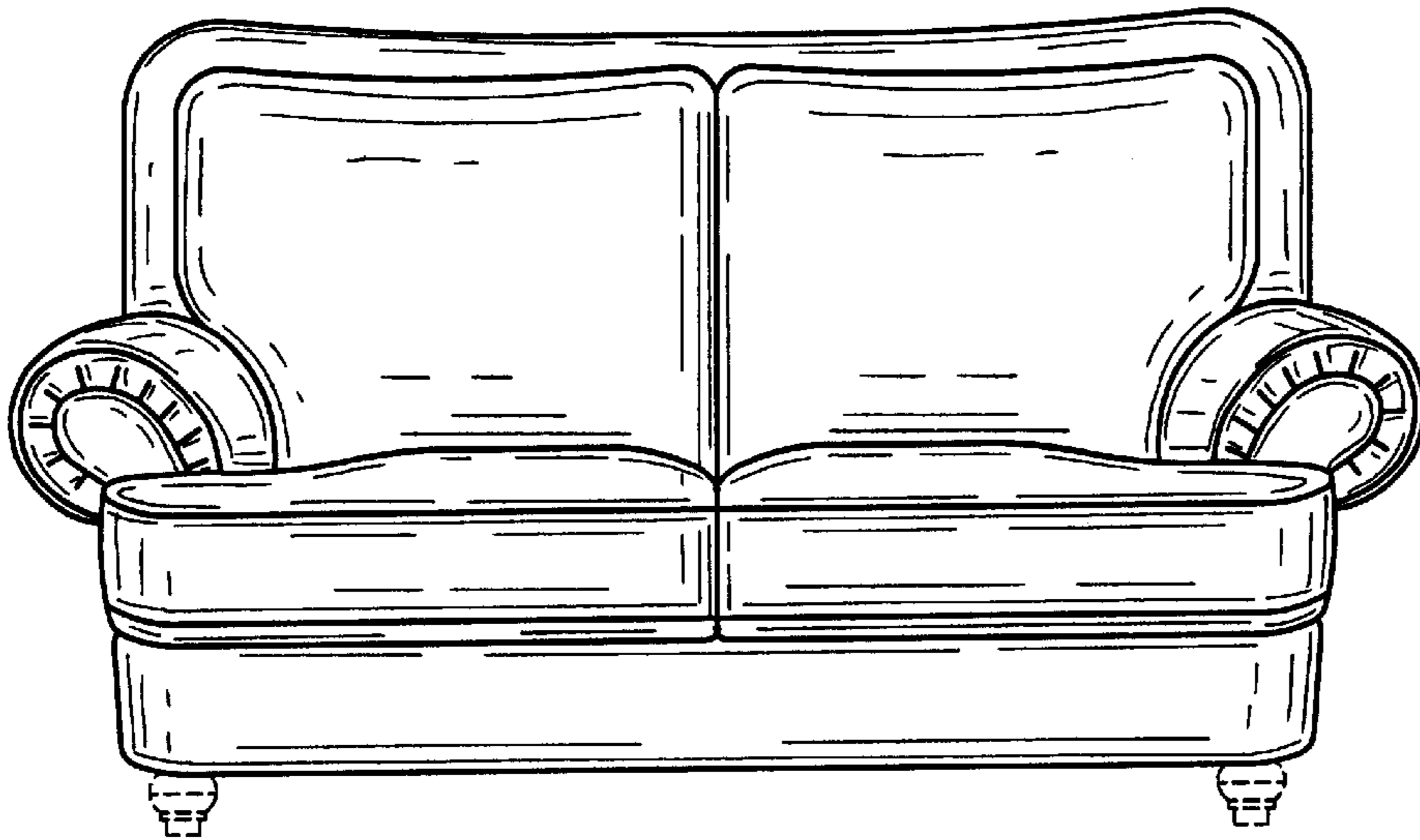

FIG. 6.

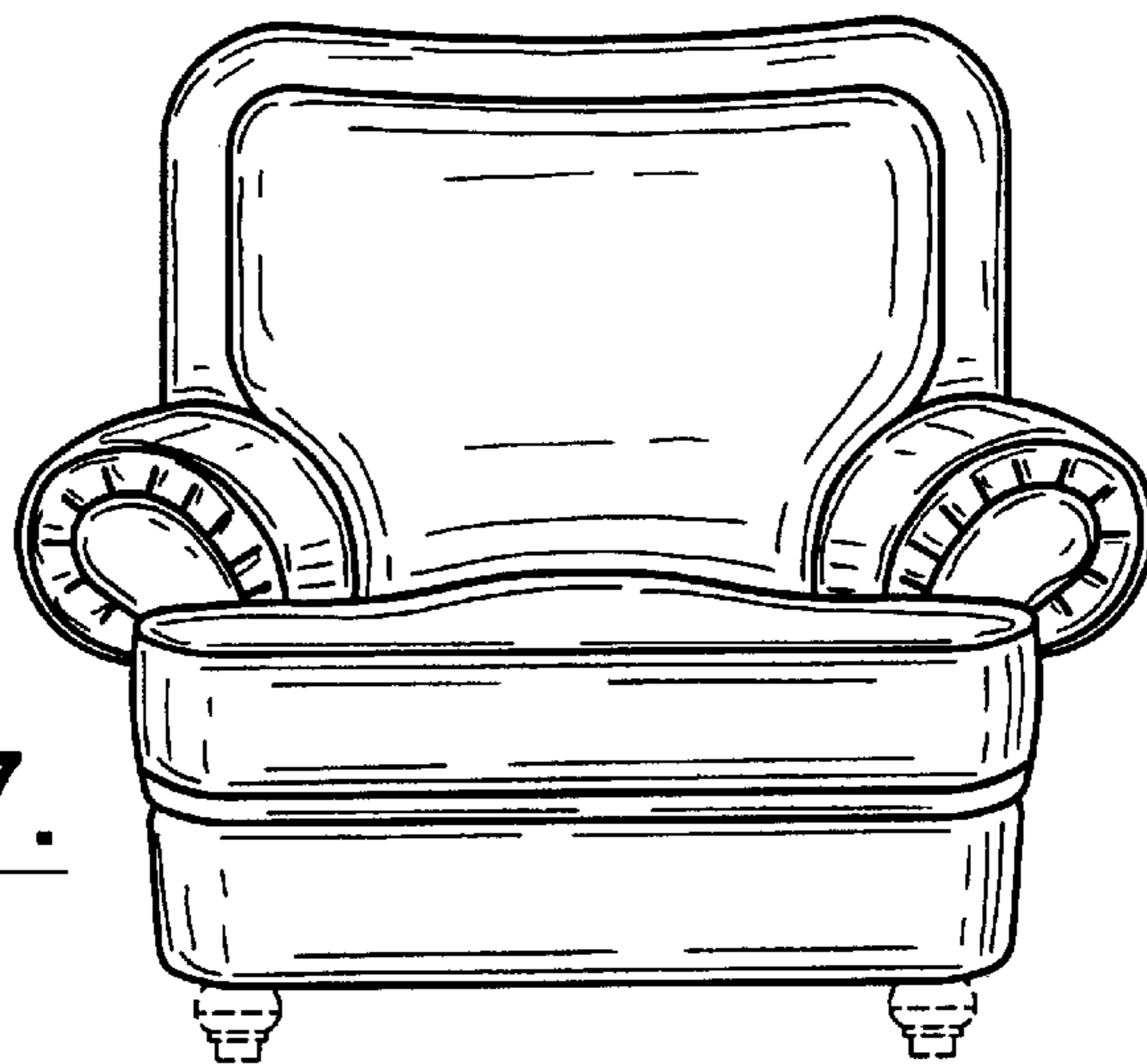

FIG. 7.