



US00D448190B1

(12) **United States Design Patent**
Chang

(10) **Patent No.:** **US D448,190 S**

(45) **Date of Patent:** **** Sep. 25, 2001**

(54) **CHAIR**

(76) Inventor: **Chien-Kuo Chang**, Fl. 10-2, No. 447,
Sec. 3, Wen-Hsin Rd., Taichung (TW)

(**) Term: **14 Years**

(21) Appl. No.: **29/130,736**

(22) Filed: **Oct. 10, 2000**

(51) **LOC (7) Cl.** **06-01**

(52) **U.S. Cl.** **D6/374; D6/380**

(58) **Field of Search** **D6/334, 374, 375,**
D6/379, 380, 500, 501, 502; 297/445.1

(56) **References Cited**

U.S. PATENT DOCUMENTS

- D. 179,770 * 2/1957 Hoven et al. D6/374
- D. 181,241 * 10/1957 Swanson D6/374
- D. 187,216 * 2/1960 Spilman D6/374
- D. 188,241 * 6/1960 Christenson, Jr. et al. D6/374
- D. 368,383 * 4/1996 Danko D6/374

- D. 374,131 * 10/1996 Muller D6/380
- D. 410,152 * 5/1999 Lombardo D6/375
- D. 414,620 * 10/1999 Kabadayan D6/380

* cited by examiner

Primary Examiner—Gary D. Watson

(74) *Attorney, Agent, or Firm*—Rosenberg, Klein & Lee

(57) **CLAIM**

The ornamental design for chair, as shown and described.

DESCRIPTION

FIG. 1 is a perspective view of chair showing my new design;

FIG. 2 is a front elevational view thereof;

FIG. 3 is a rear elevational view thereof;

FIG. 4 is a left side elevational view thereof;

FIG. 5 is a right side elevational view thereof;

FIG. 6 is a top side elevational view thereof; and,

FIG. 7 is a bottom side elevational view thereof.

1 Claim, 4 Drawing Sheets

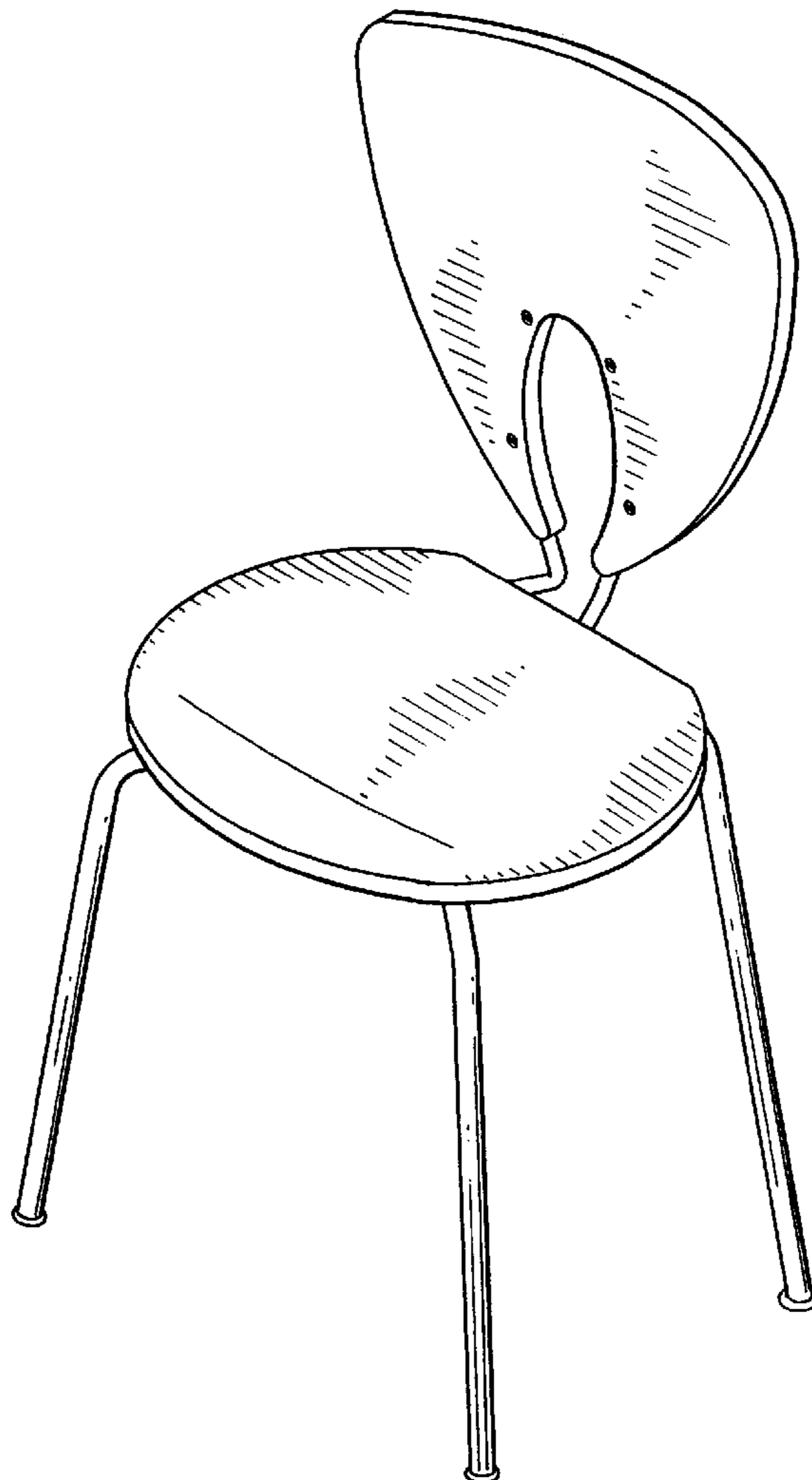

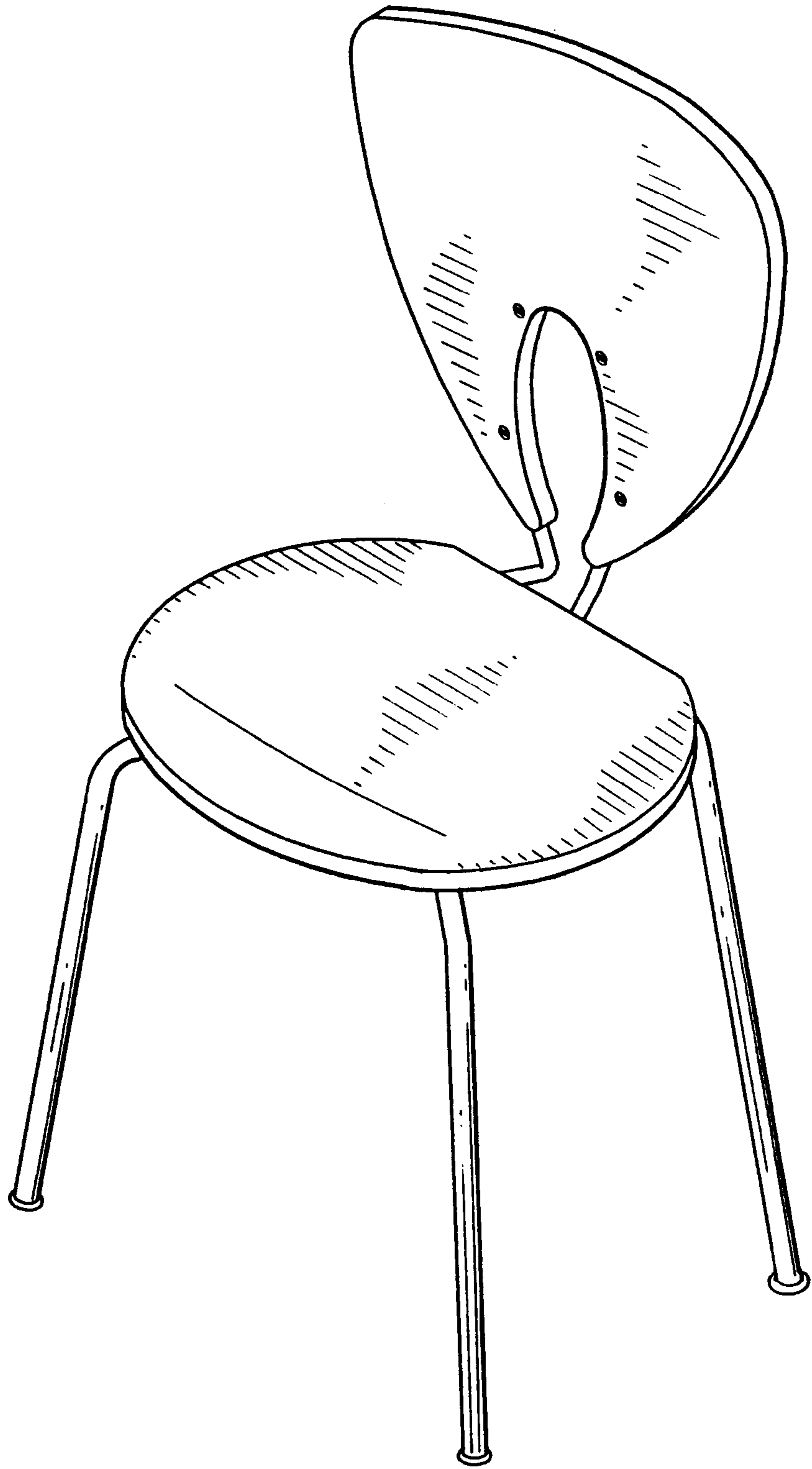

FIG. 1

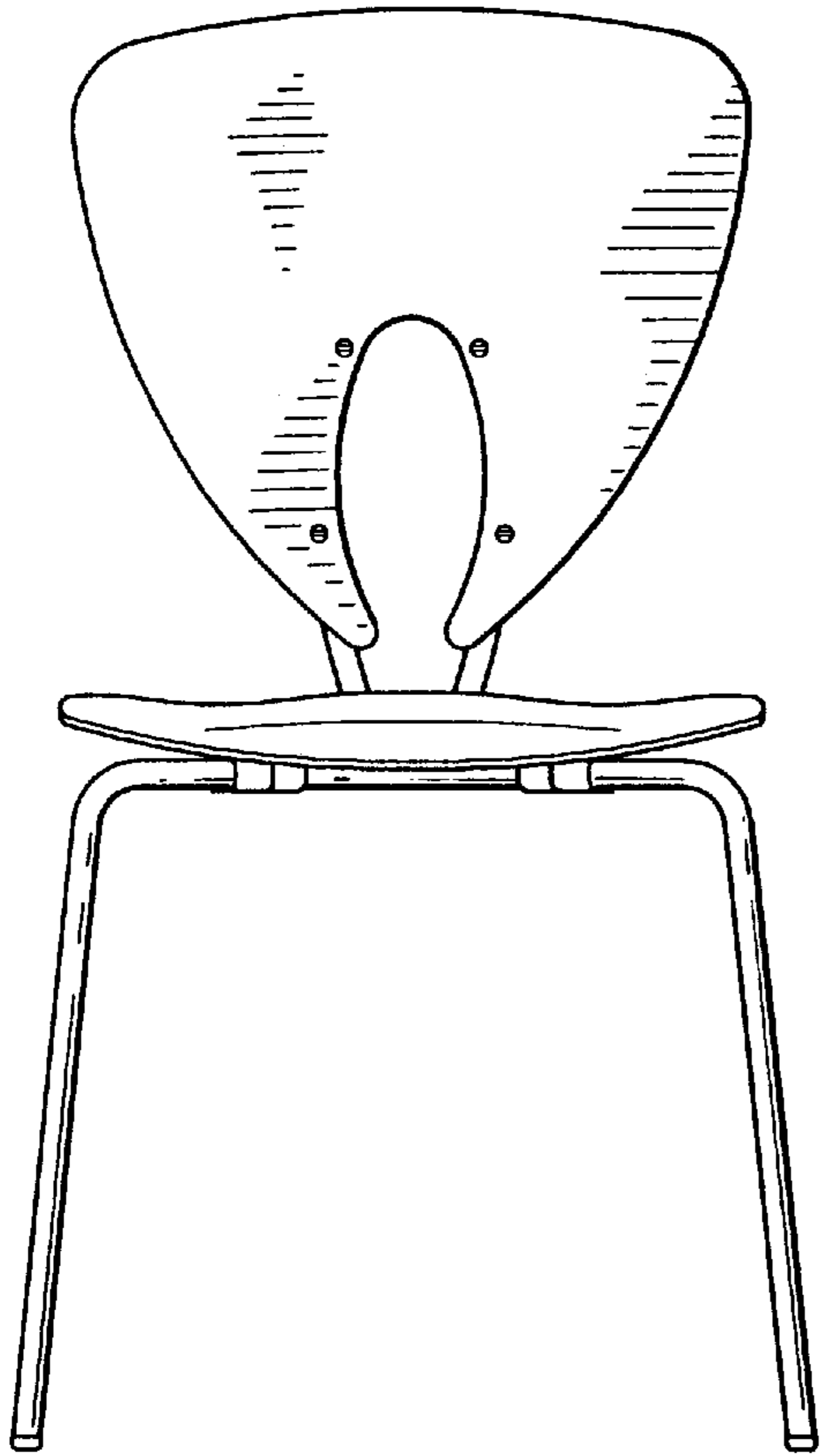

FIG. 2

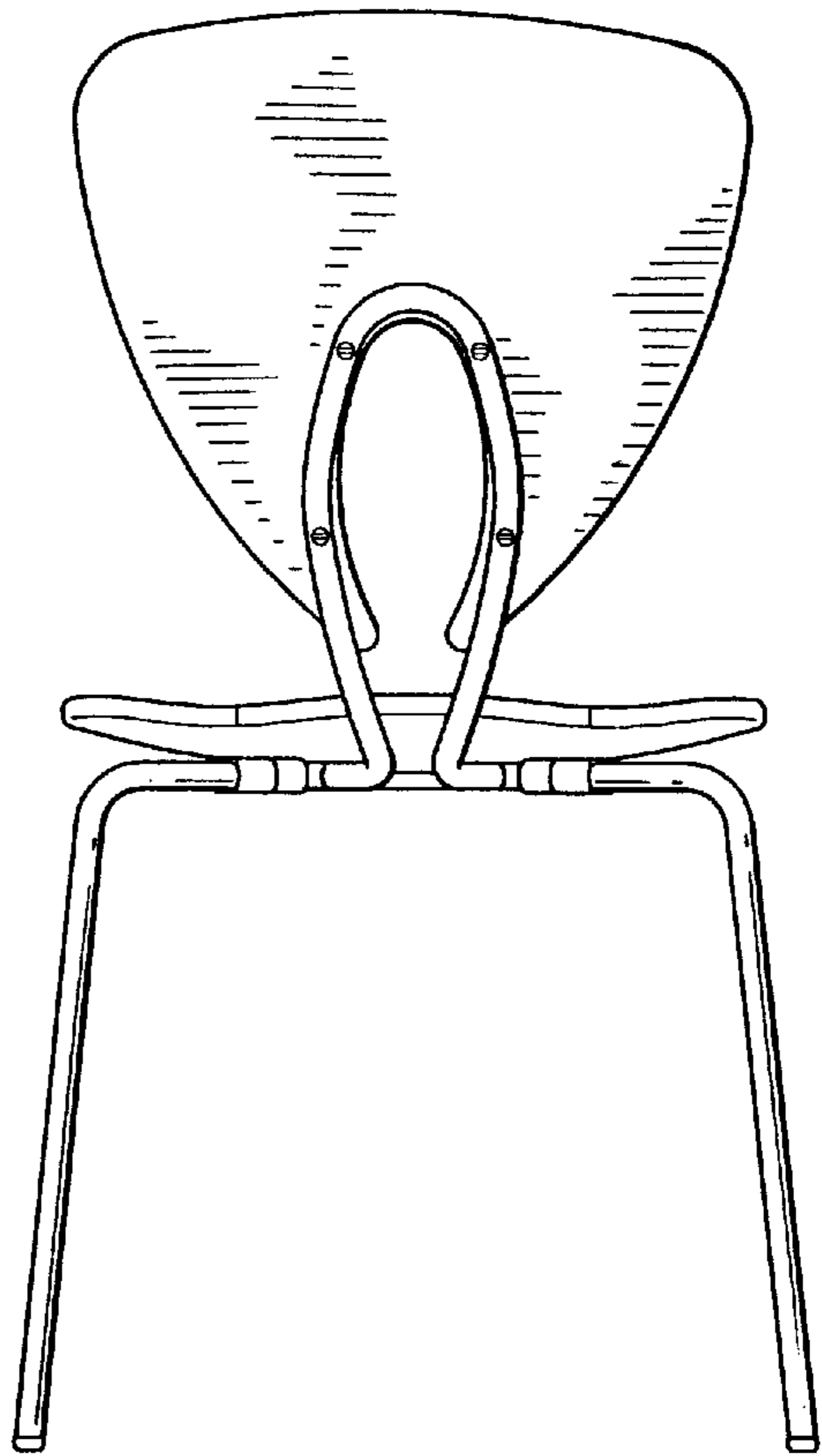

FIG. 3

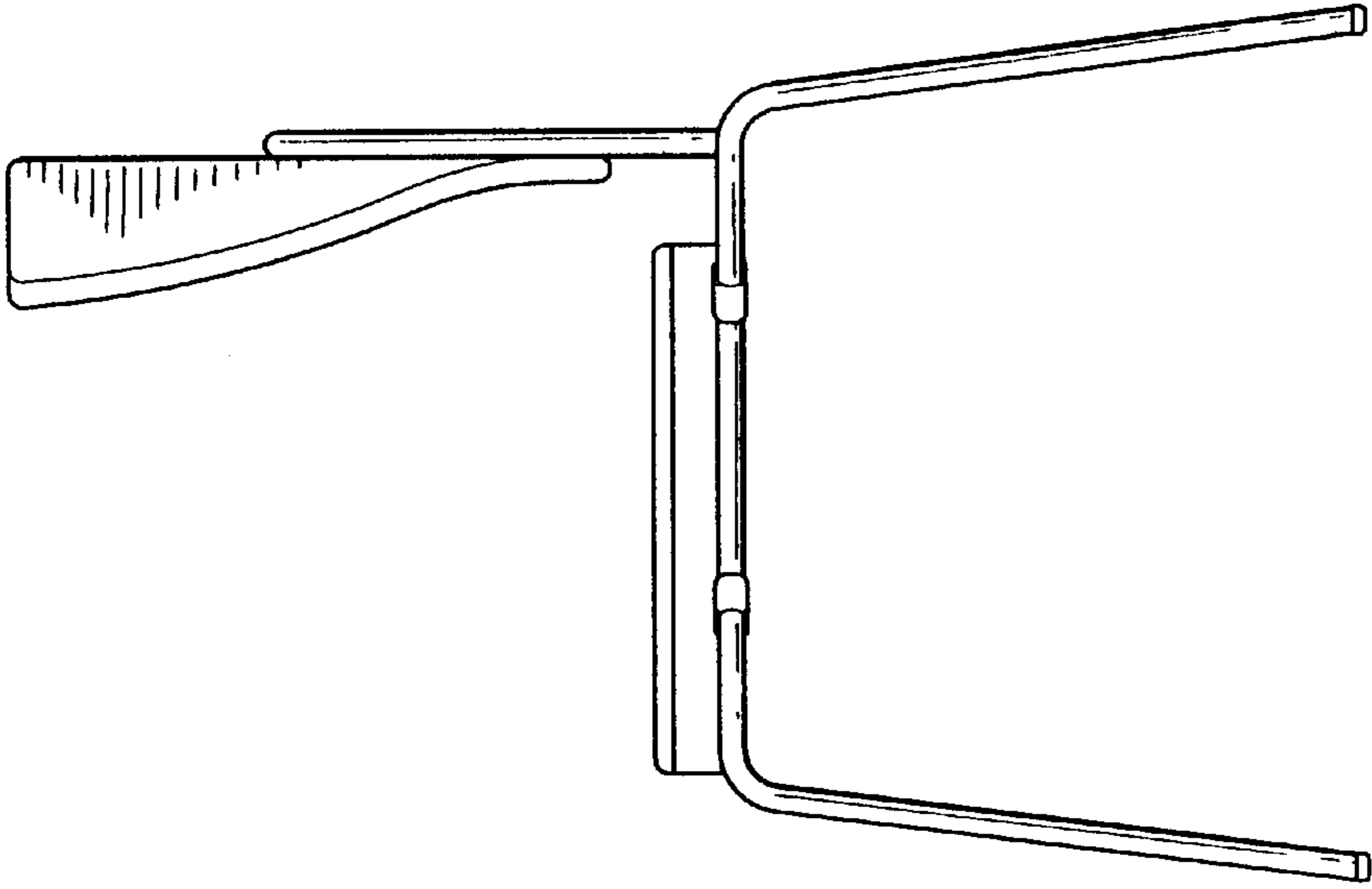

FIG. 5

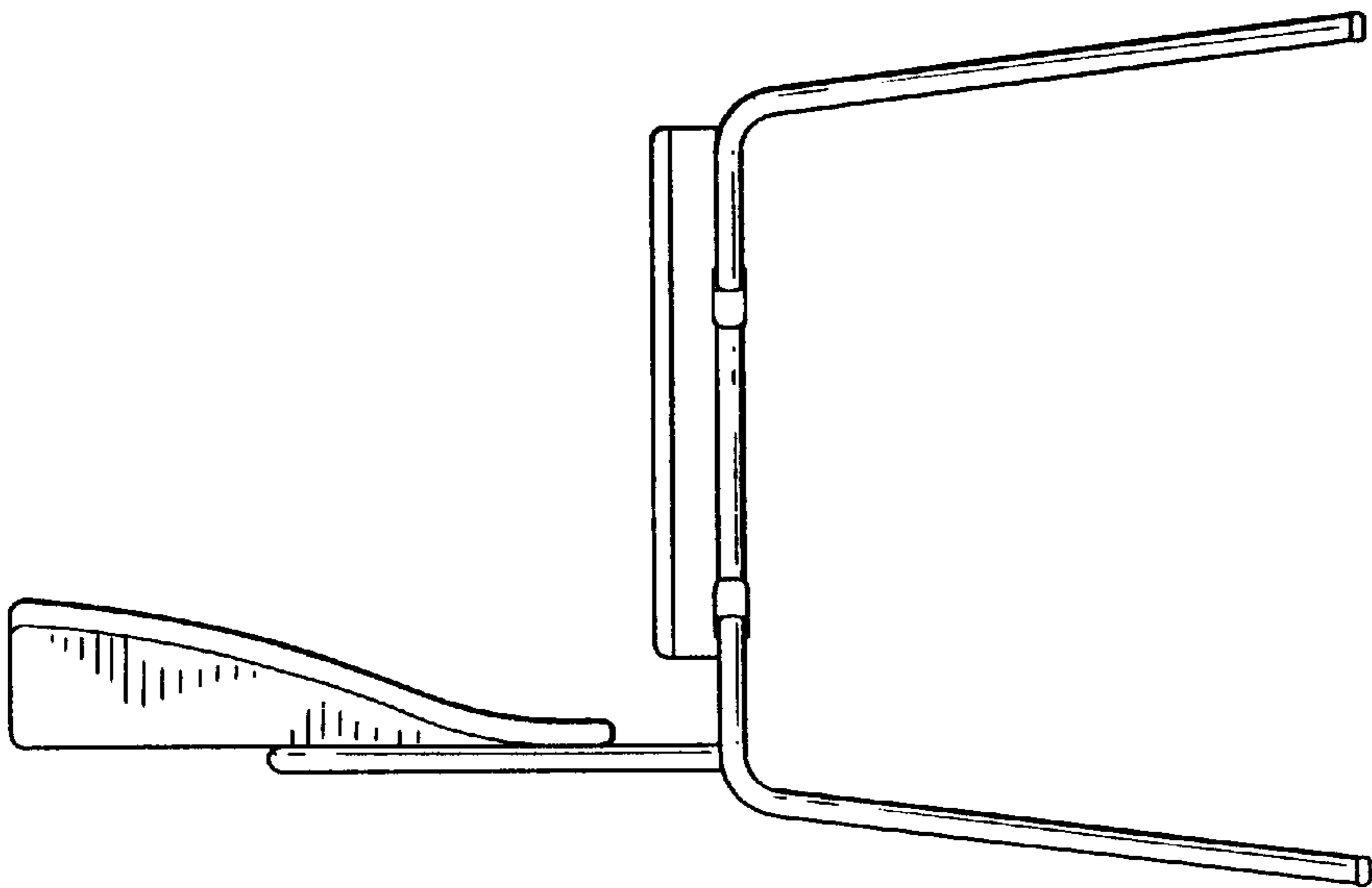

FIG. 4

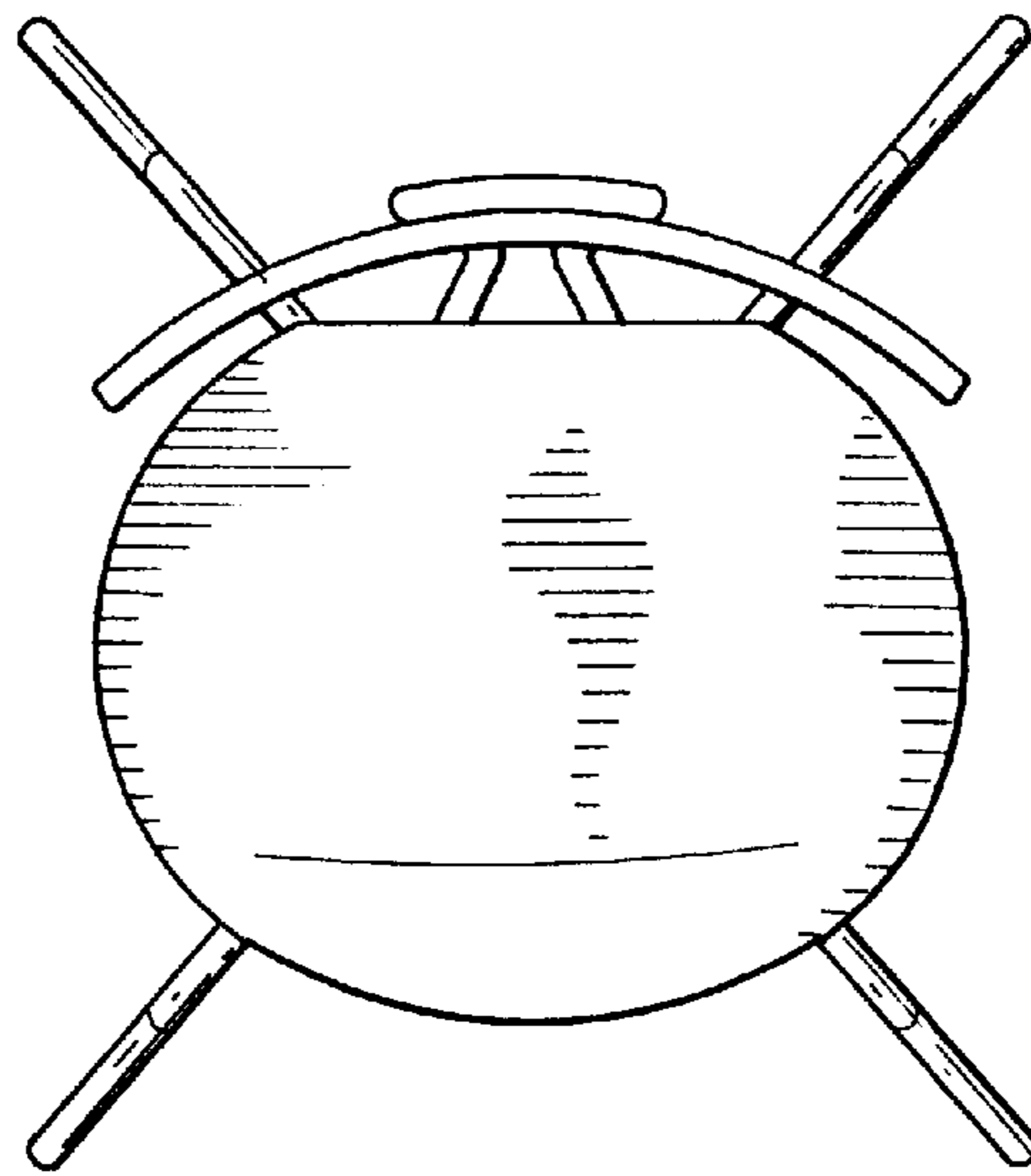

FIG. 6

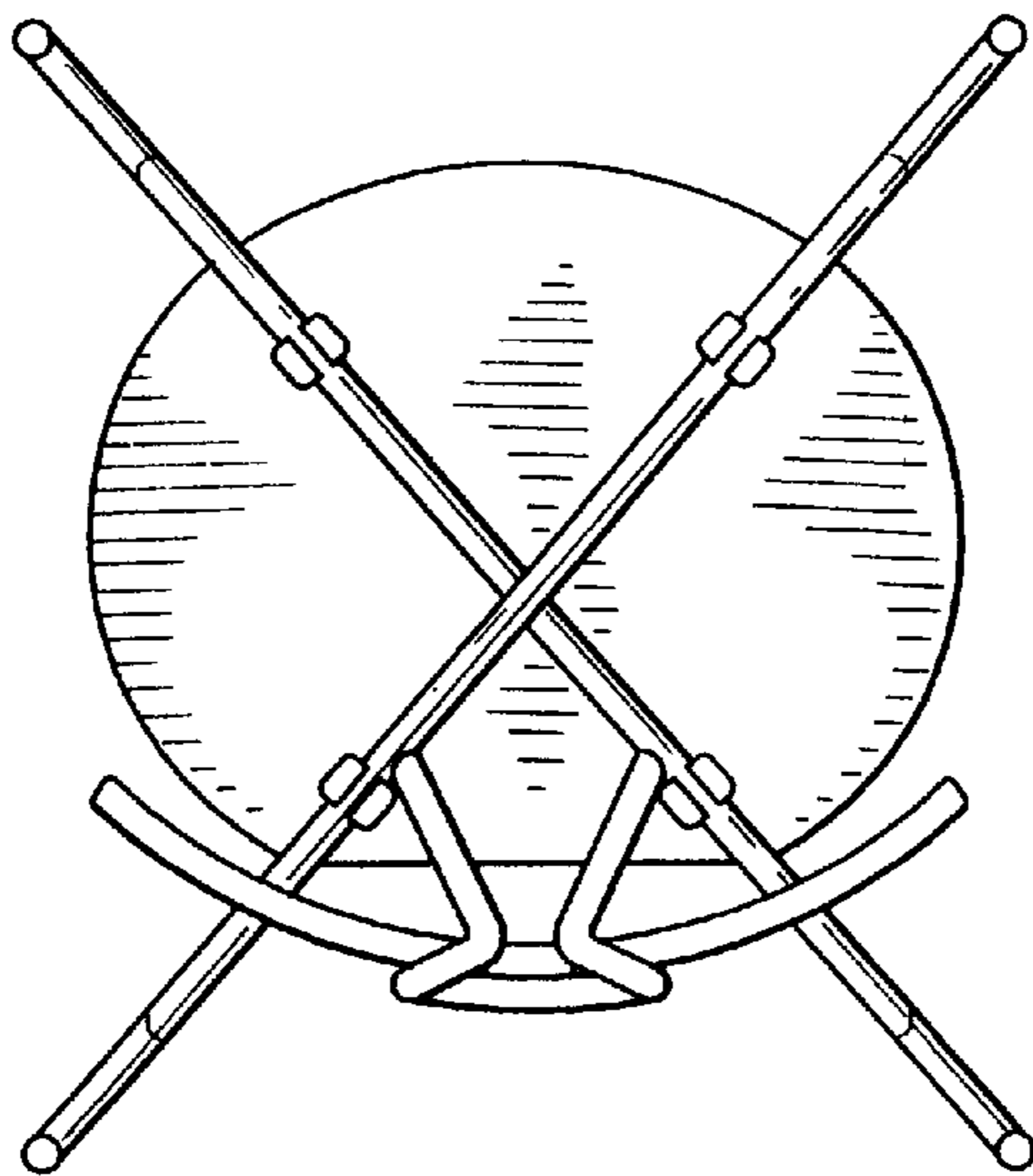

FIG. 7