



US00D448188B1

(12) **United States Design Patent**
Caldwell

(10) **Patent No.:** **US D448,188 S**

(45) **Date of Patent:** **** Sep. 25, 2001**

(54) **CHAIR**

D. 429,424 * 8/2000 Vanderminster, Sr. D6/379 X

(76) Inventor: **John W. Caldwell**, 1829 Warwick Rd.,
San Marino, CA (US) 91108

* cited by examiner

(**) Term: **14 Years**

Primary Examiner—Gary D. Watson

(74) *Attorney, Agent, or Firm*—Donald D. Mon

(21) Appl. No.: **29/132,068**

(57) **CLAIM**

(22) Filed: **Oct. 31, 2000**

The ornamental design for a chair, as shown and described.

(51) **LOC (7) Cl.** **06-01**

DESCRIPTION

(52) **U.S. Cl.** **D6/370; D6/376**

FIG. 1 is a perspective view of a chair according to the invention;

(58) **Field of Search** D6/334, 335, 370,
D6/374, 376, 379, 380, 500, 501, 502;
297/445.1, 452.63

FIG. 2 is a right side view of the chair of FIG. 1, the left side view being a mirror image of it;

FIG. 3 is a top view of the chair;

FIG. 4 is a bottom view of the chair;

FIG. 5 is a front view of the chair; and,

FIG. 6 is a rear view of the chair.

(56) **References Cited**

U.S. PATENT DOCUMENTS

- D. 369,477 * 5/1996 Arthur, Jr. D6/379
- D. 372,134 * 7/1996 Martin D6/376
- D. 420,824 * 2/2000 Lin D6/370

1 Claim, 3 Drawing Sheets

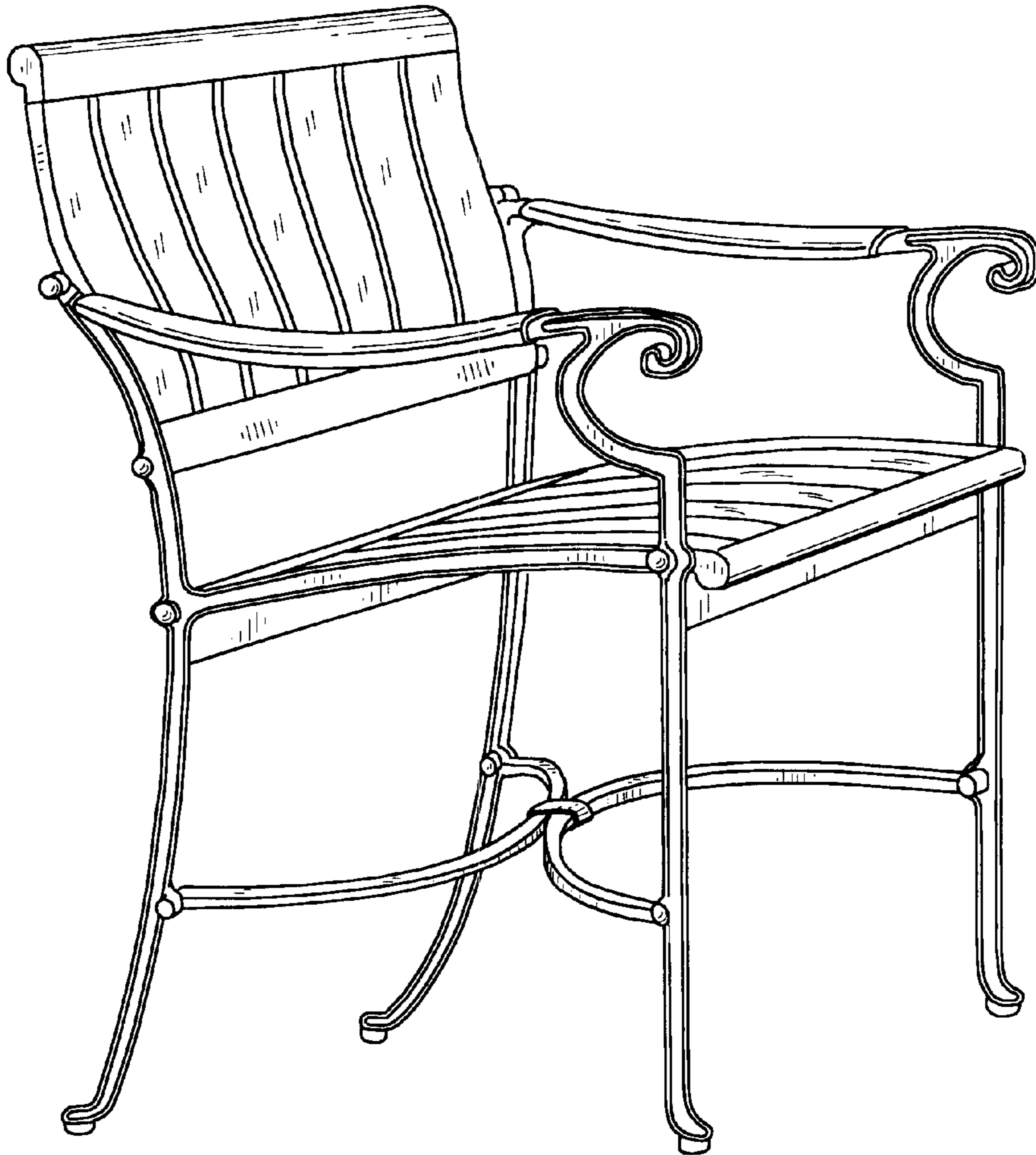

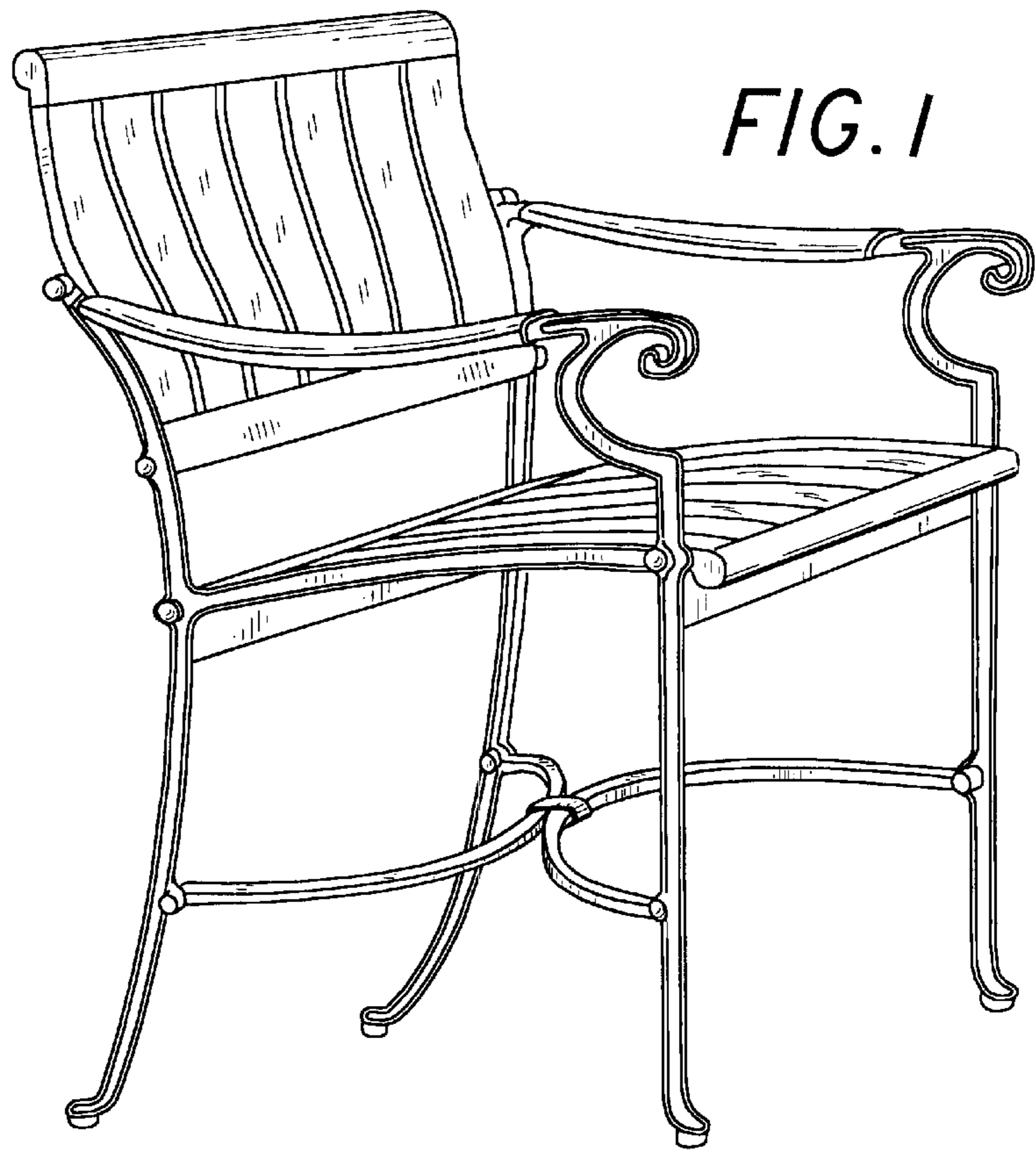

FIG. 1

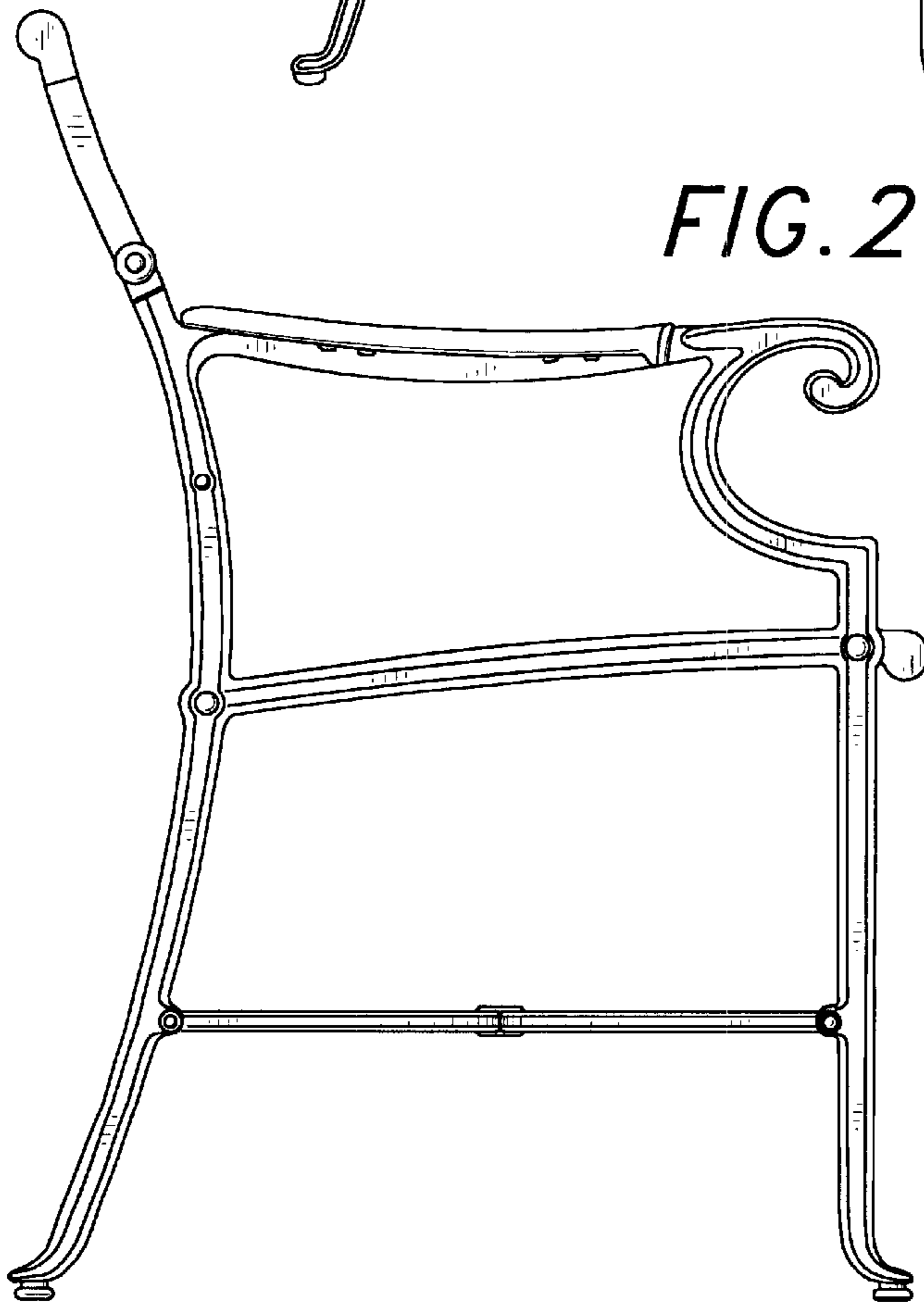

FIG. 2

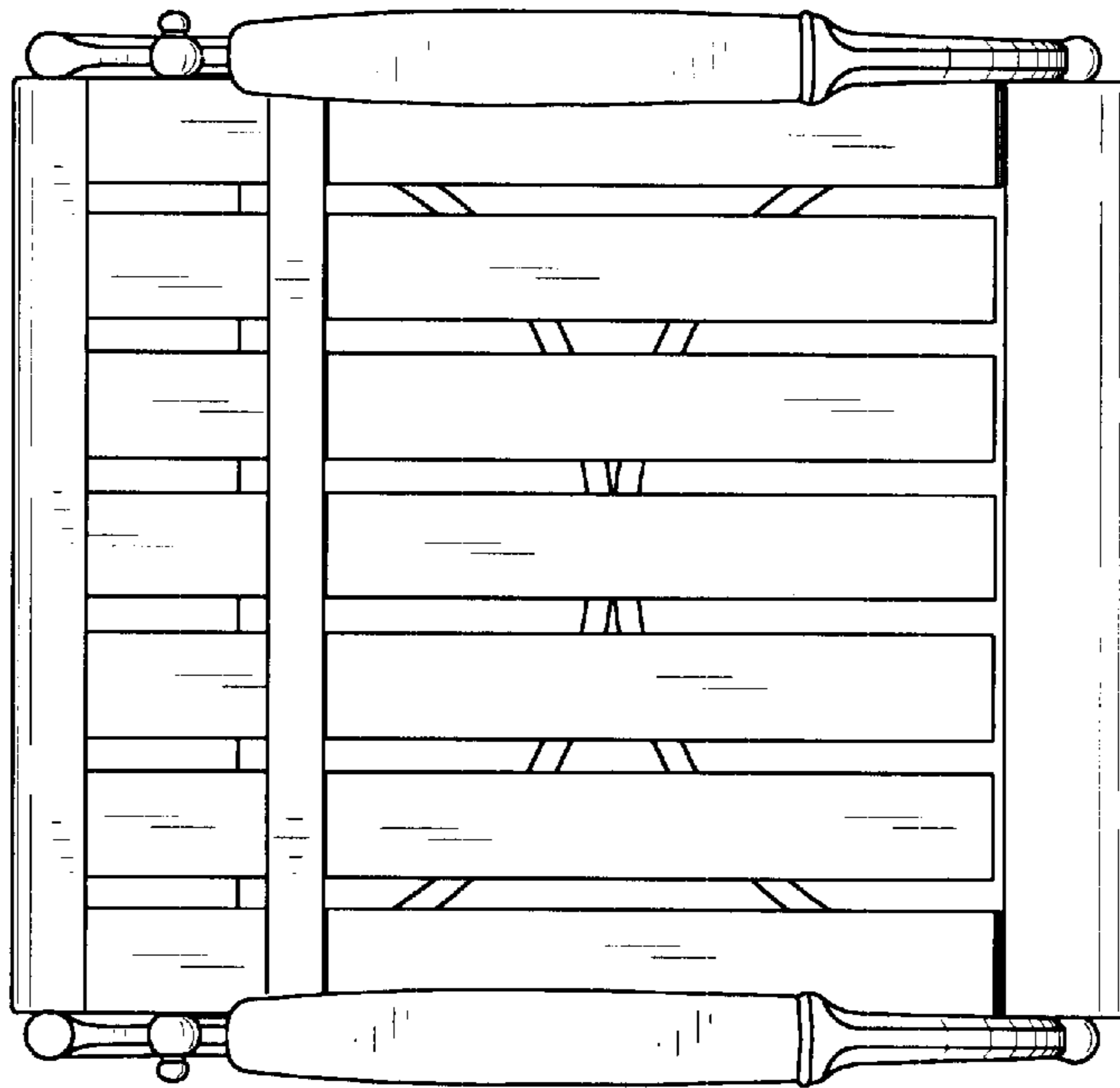

FIG. 3

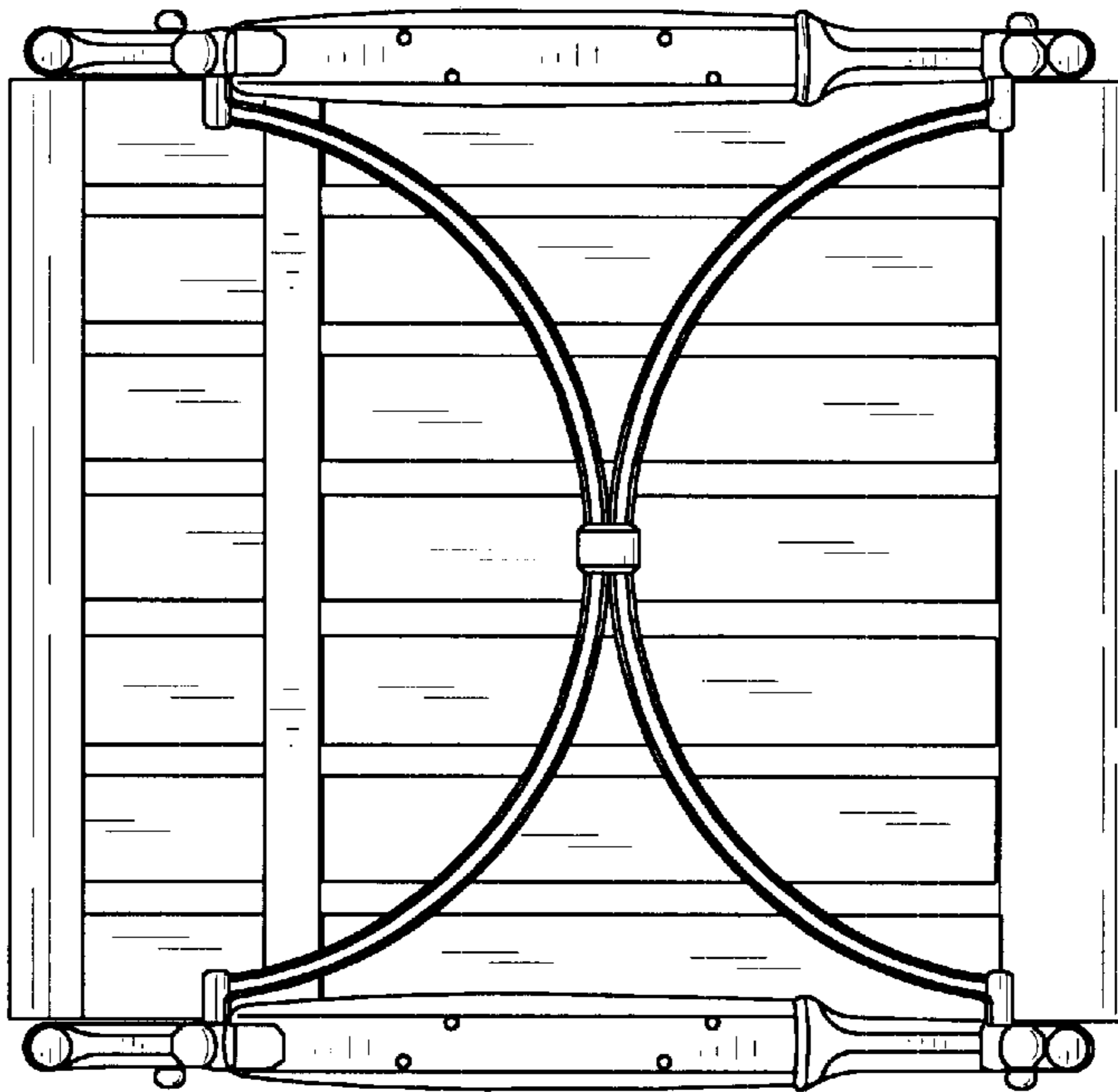

FIG. 4

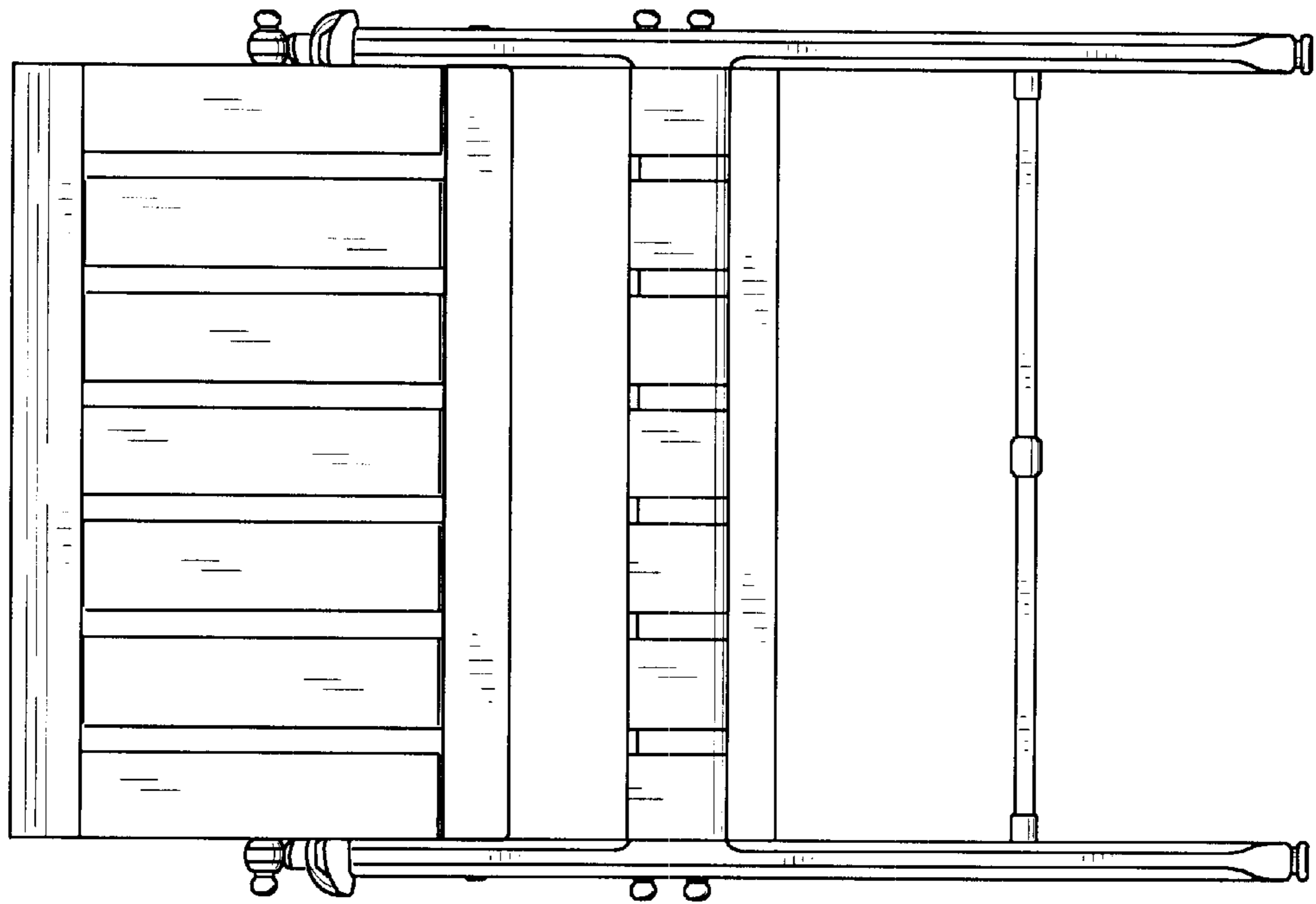

FIG. 6

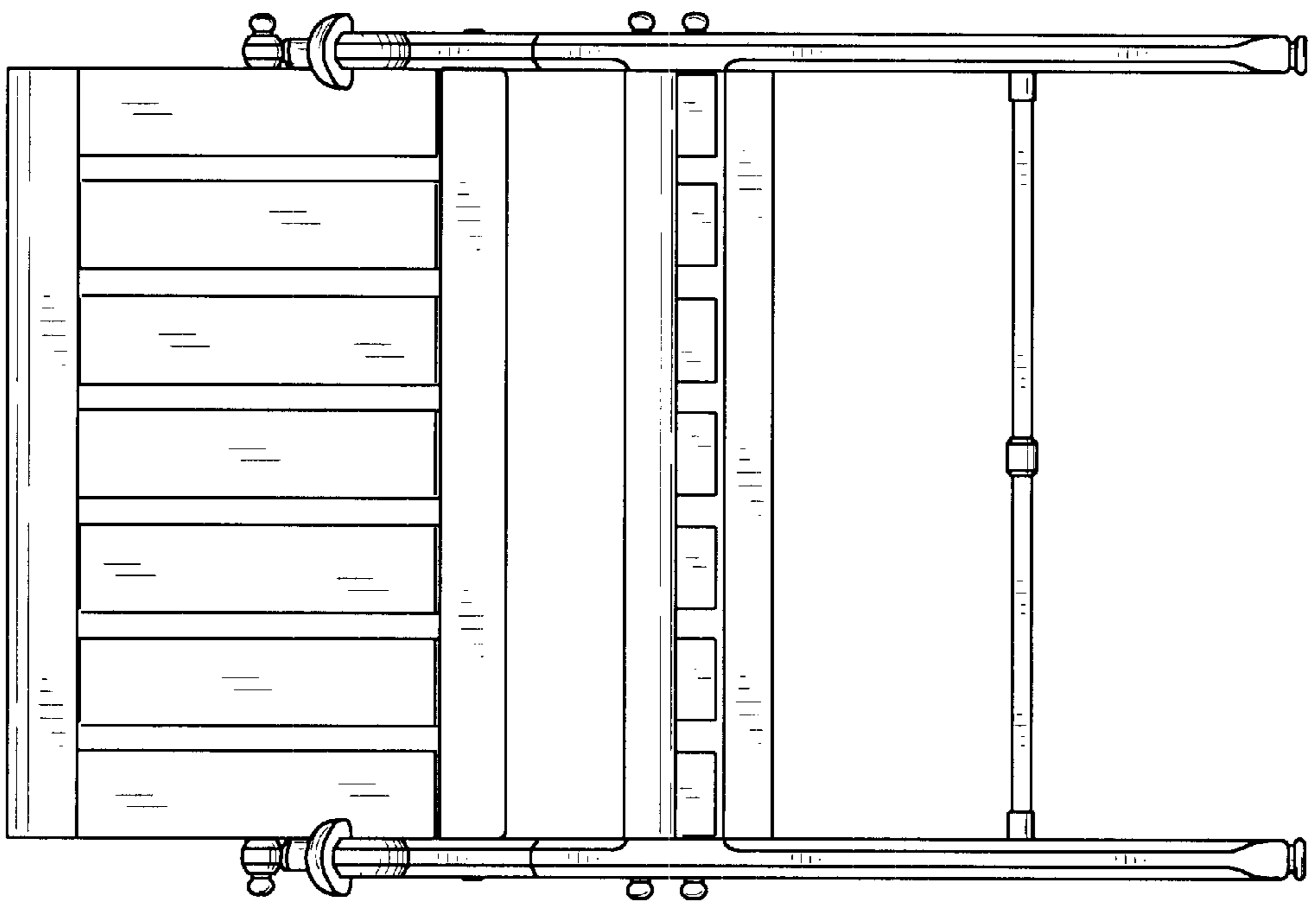

FIG. 5