



US00D448037B1

(12) **United States Design Patent**
Westimayer et al.

(10) **Patent No.:** **US D448,037 S**

(45) **Date of Patent:** **** Sep. 18, 2001**

(54) **OUTER SURFACE OF A HOOD**

(75) Inventors: **David Anthony Westimayer**, Horicon;
Matthew Paul Gueller, Slinger, both of
WI (US); **Daniel Robert Nickles**, St.
Thomas (VG); **Thomas Howard Ward**,
Ventura, CA (US)

(73) Assignee: **Deere & Company**, Moline, IL (US)

(**) Term: **14 Years**

(21) Appl. No.: **29/132,230**

(22) Filed: **Nov. 3, 2000**

(51) **LOC (7) Cl.** **15-03**

(52) **U.S. Cl.** **D15/31**

(58) **Field of Search** D15/14-18, 23,
D15/28, 31; 56/13.3, 13.4, 16.1, 17.4, 15.8,
15.9, 16.7, 202, 255, 294, 320.1, 320.2;
180/900, 273, 68.6, 69.21

(56) **References Cited**

U.S. PATENT DOCUMENTS

D. 209,043	*	10/1967	Purcell et al.	D15/28
D. 248,397	*	7/1978	Cognata et al.	D15/15
D. 297,538	*	9/1988	Ogasawara et al.	D15/15
D. 310,374		9/1990	Westimayer et al.	D15/15
D. 311,543		10/1990	Hardzinski et al.	D15/17
D. 329,242		9/1992	Holm et al.	D15/17
D. 354,756	*	1/1995	Hinklin	D15/15
D. 365,573		12/1995	Westimayer et al.	D15/17
D. 371,372		7/1996	Westimayer et al.	D15/31
D. 381,341		7/1997	Goebert et al.	D15/31
D. 382,279	*	8/1997	Goebert et al.	D15/31
D. 383,470		9/1997	Westimayer et al.	D15/31
D. 392,982	*	3/1998	Smith	D15/17

D. 410,012		5/1999	Goebert et al.	D15/31
D. 411,210		6/1999	Goebert et al.	D15/31
D. 421,266	*	2/2000	Hinklin	D15/15
D. 427,205	*	6/2000	Shimizu	D15/23
D. 440,233	*	4/2001	Smith	D15/17
D. 440,982	*	4/2001	Knight et al.	D15/23
4,620,575	*	11/1986	Cuba et al.	180/307

* cited by examiner

Primary Examiner—Mitchell Siegel

(57) **CLAIM**

The ornamental design for an outer surface of a hood, as shown and described.

DESCRIPTION

FIG. 1 is a left front elevated perspective view of an outer surface of a hood, showing our new design, the broken line showing of the vehicle being for illustrative purposes only, and forms no part of the claimed design.

FIG. 2 is a left front enlarged and elevated perspective view of the outer surface of a hood design of FIG. 1.

FIG. 3 is a plan view of the outer surface of a hood design of FIG. 1.

FIG. 4 is a left side view of the outer surface of a hood design of FIG. 1.

FIG. 5 is a front view of the outer surface of a hood design of FIG. 1.

FIG. 6 is a right side view of the outer surface of a hood design of FIG. 1.

FIG. 7 is a rear view of the outer surface of a hood design of FIG. 1; and,

FIG. 8 is a bottom view of the outer surface of a hood design of FIG. 1.

1 Claim, 4 Drawing Sheets

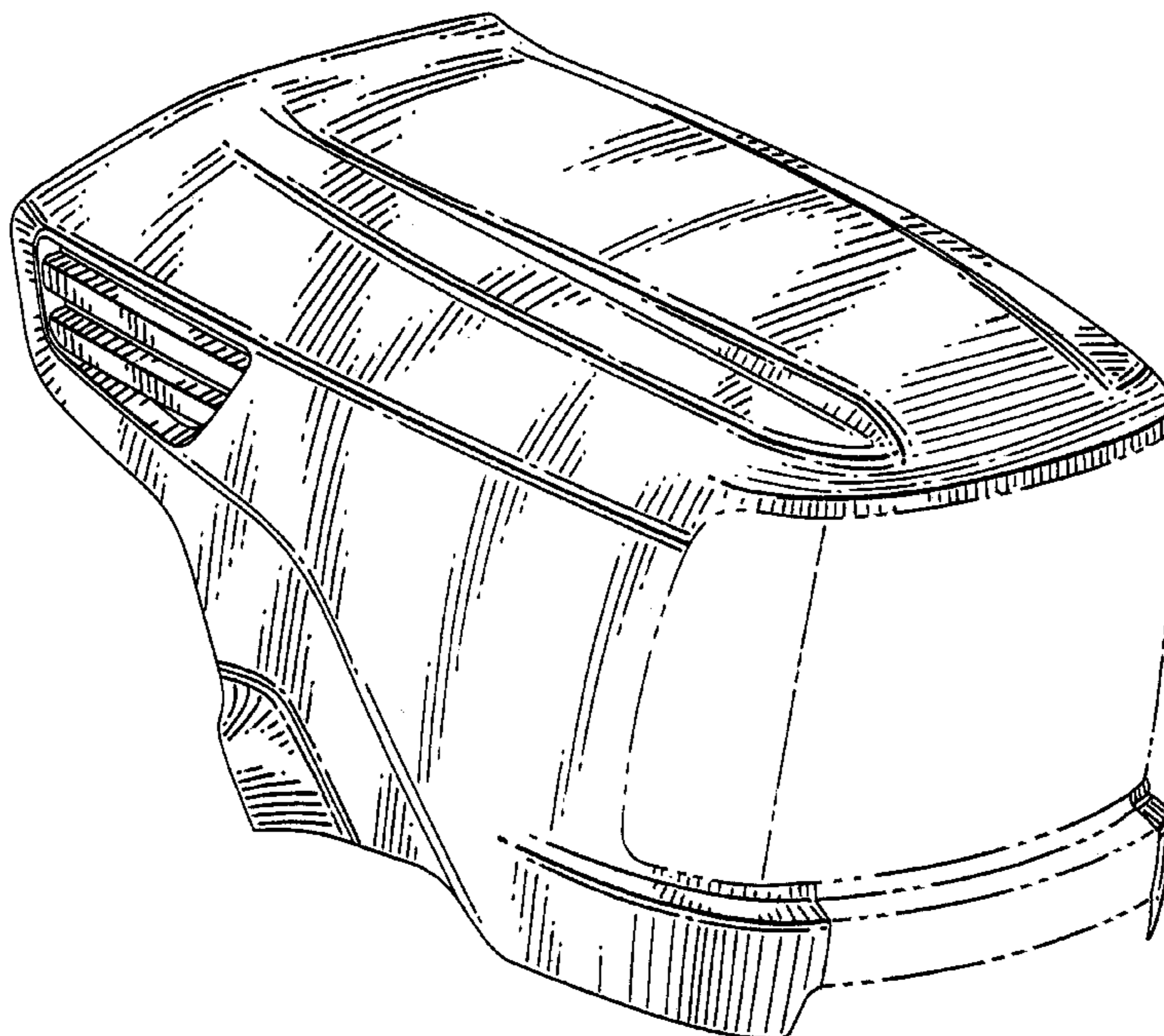

Fig. 1

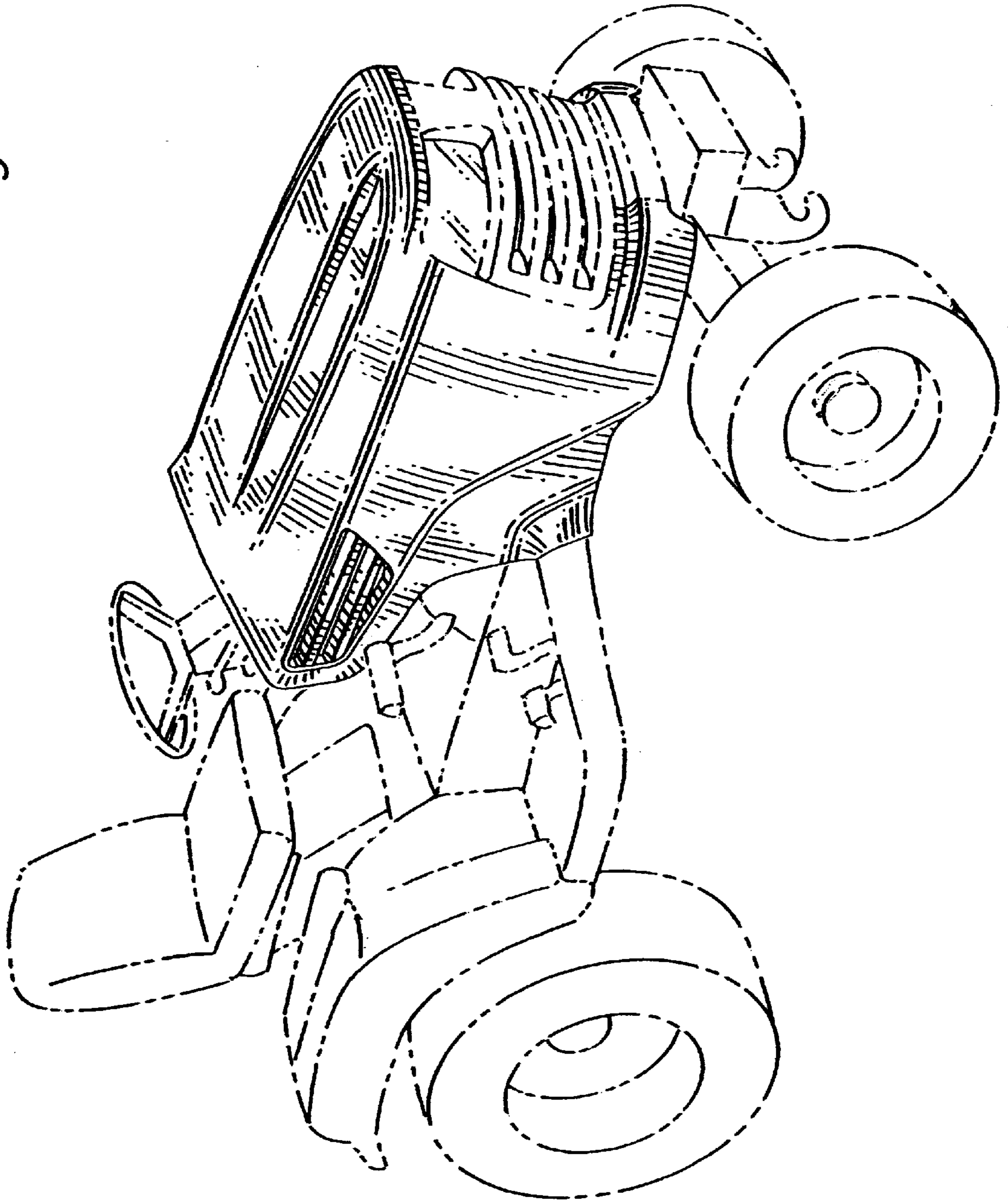
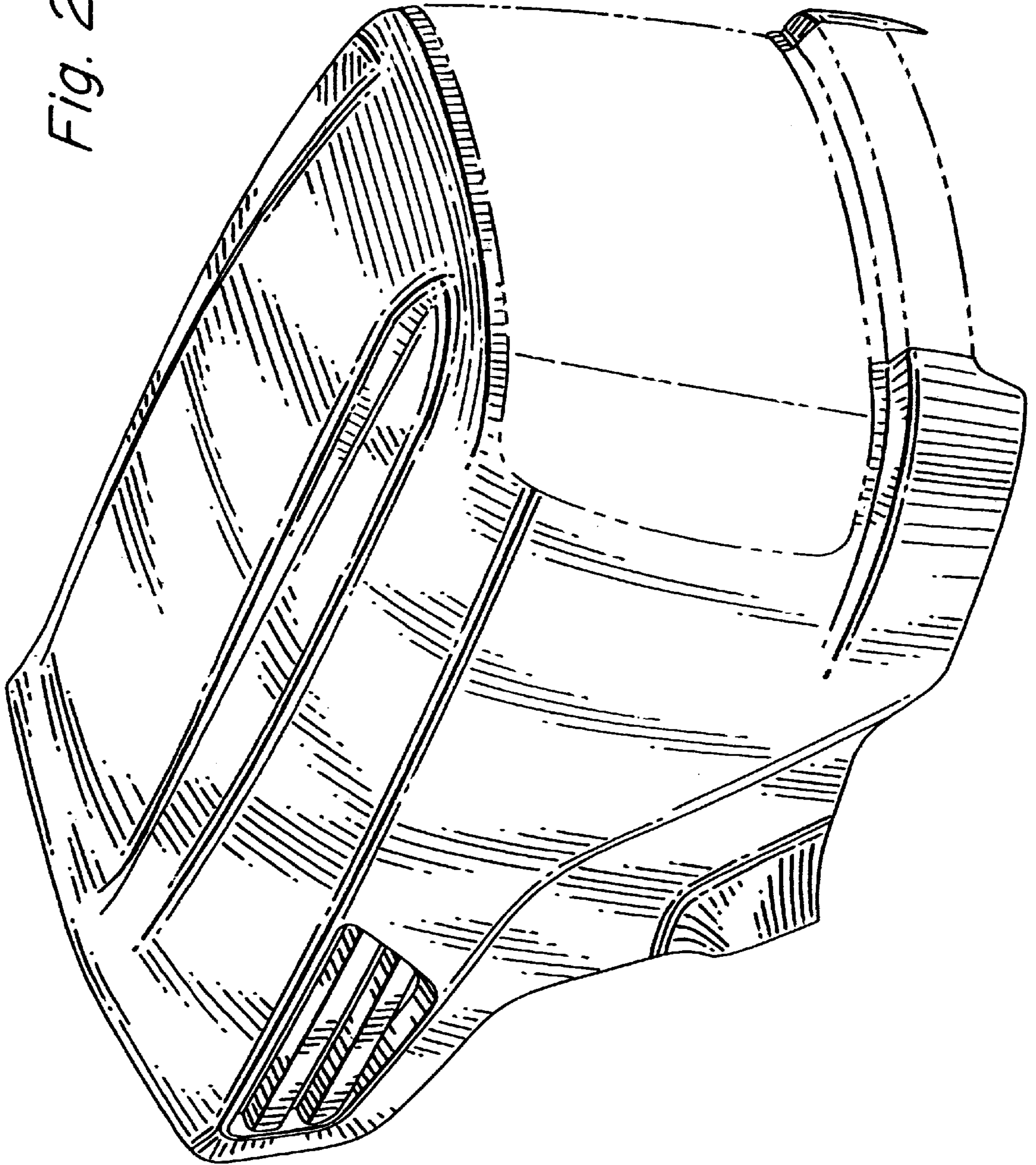

Fig. 2



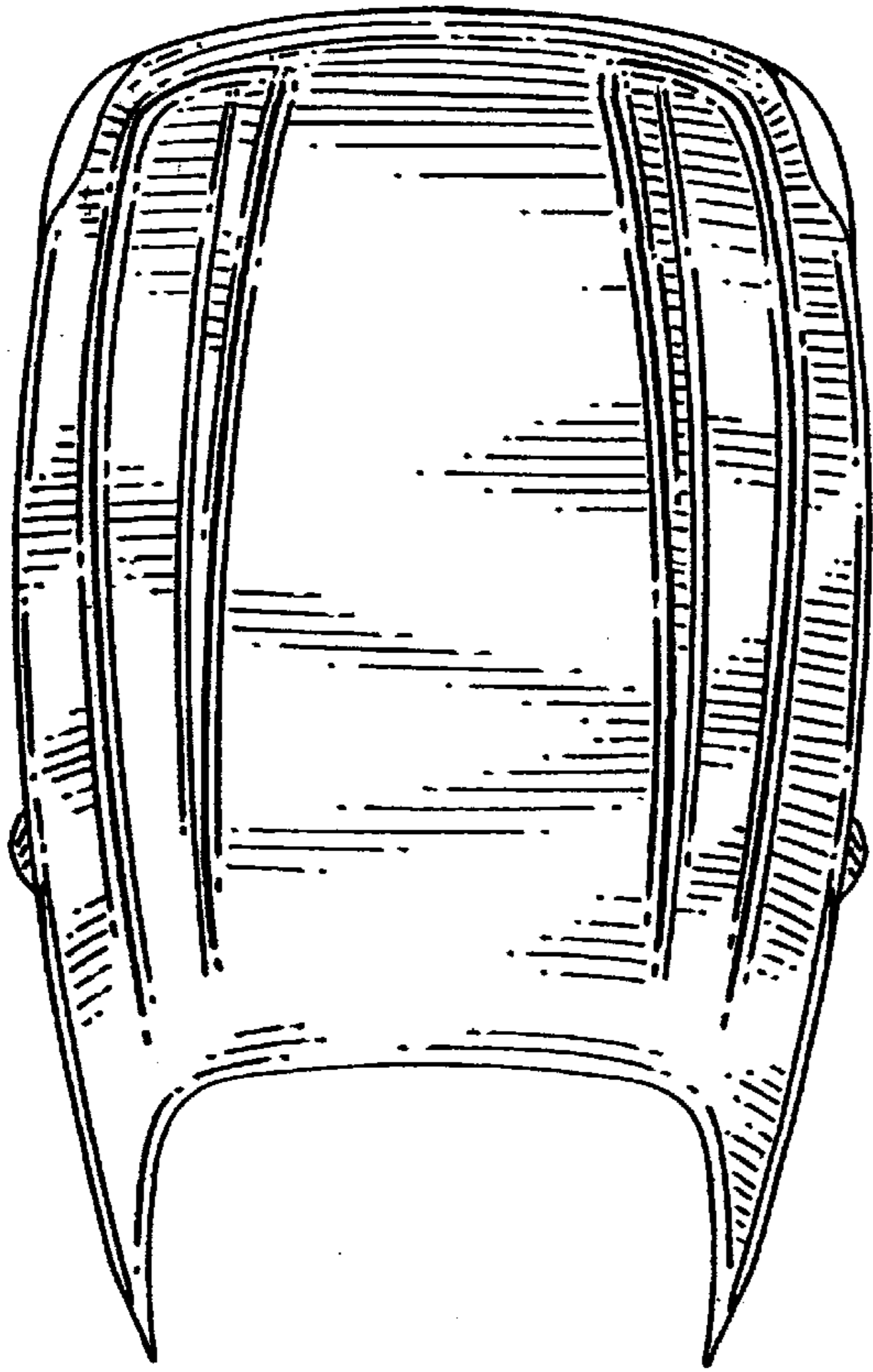

Fig. 3

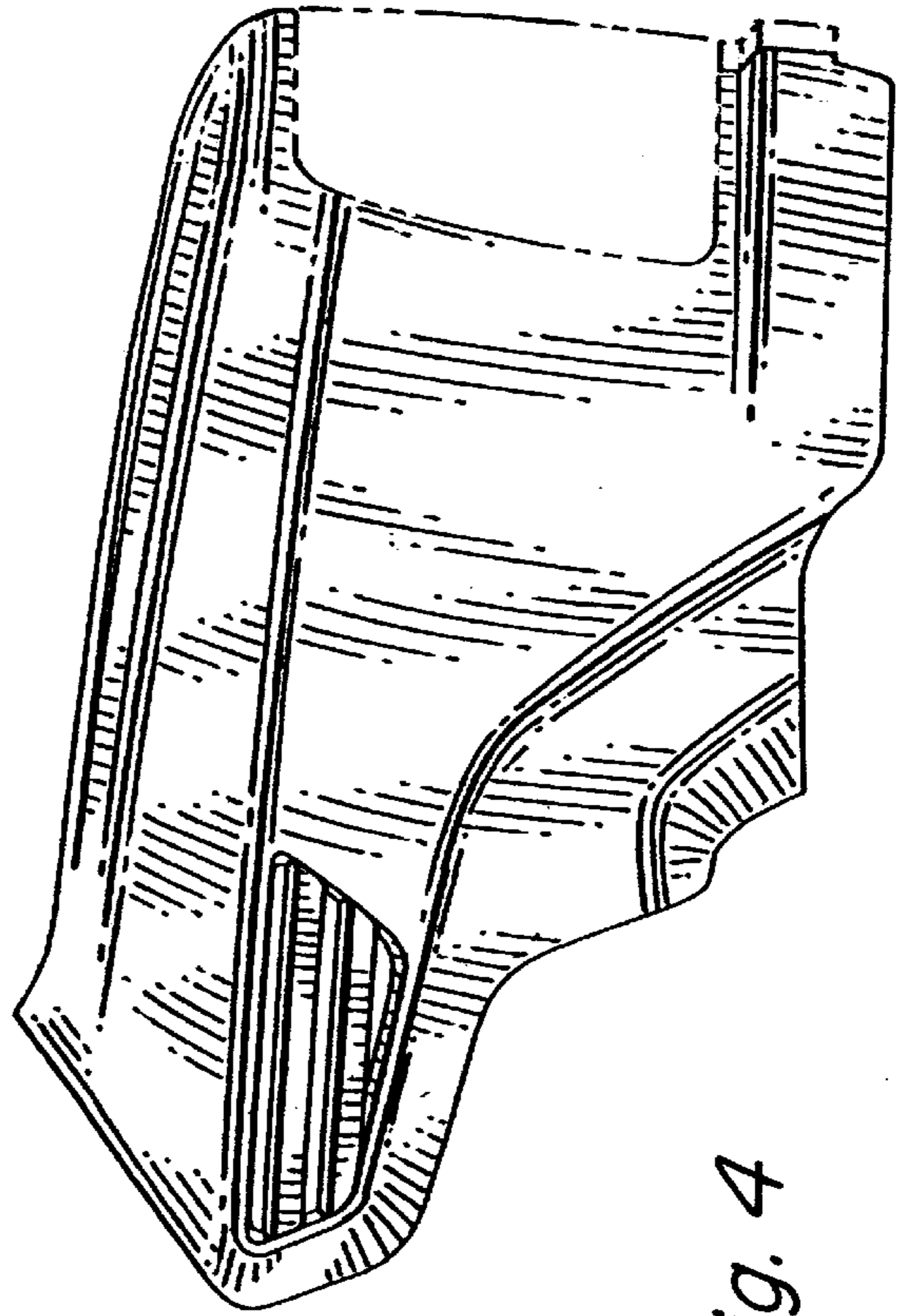
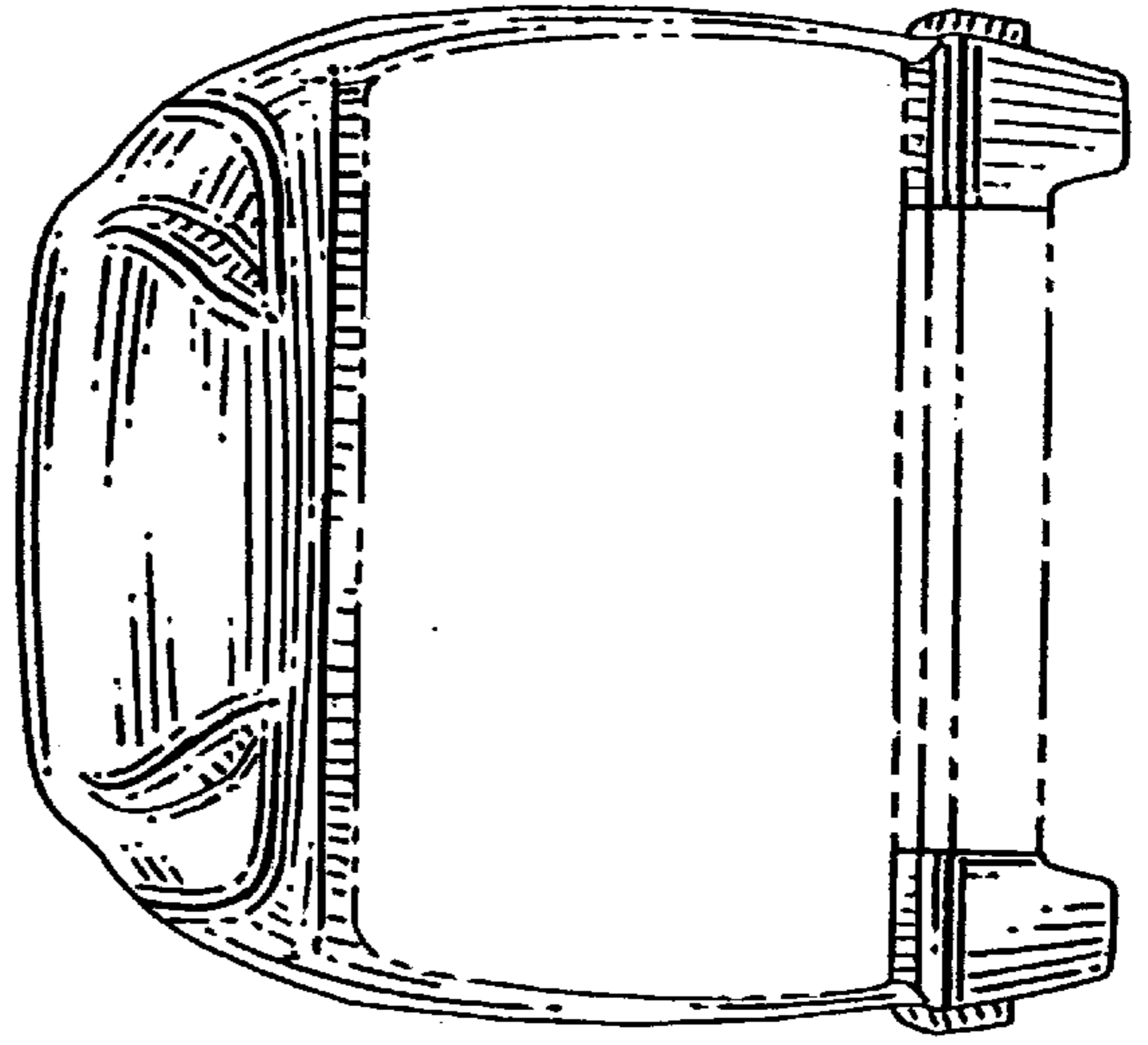

Fig. 4

Fig. 5



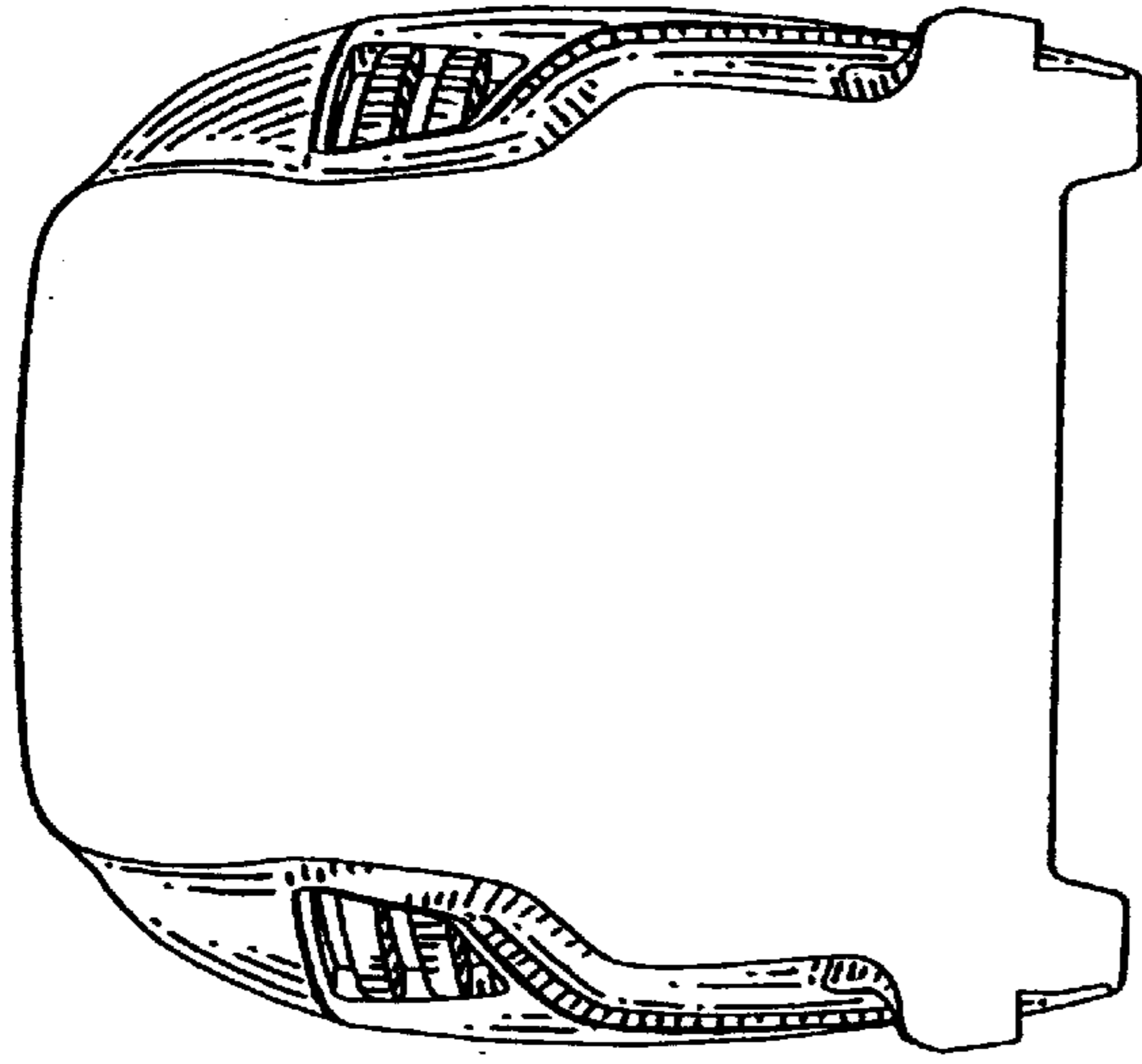

Fig. 7

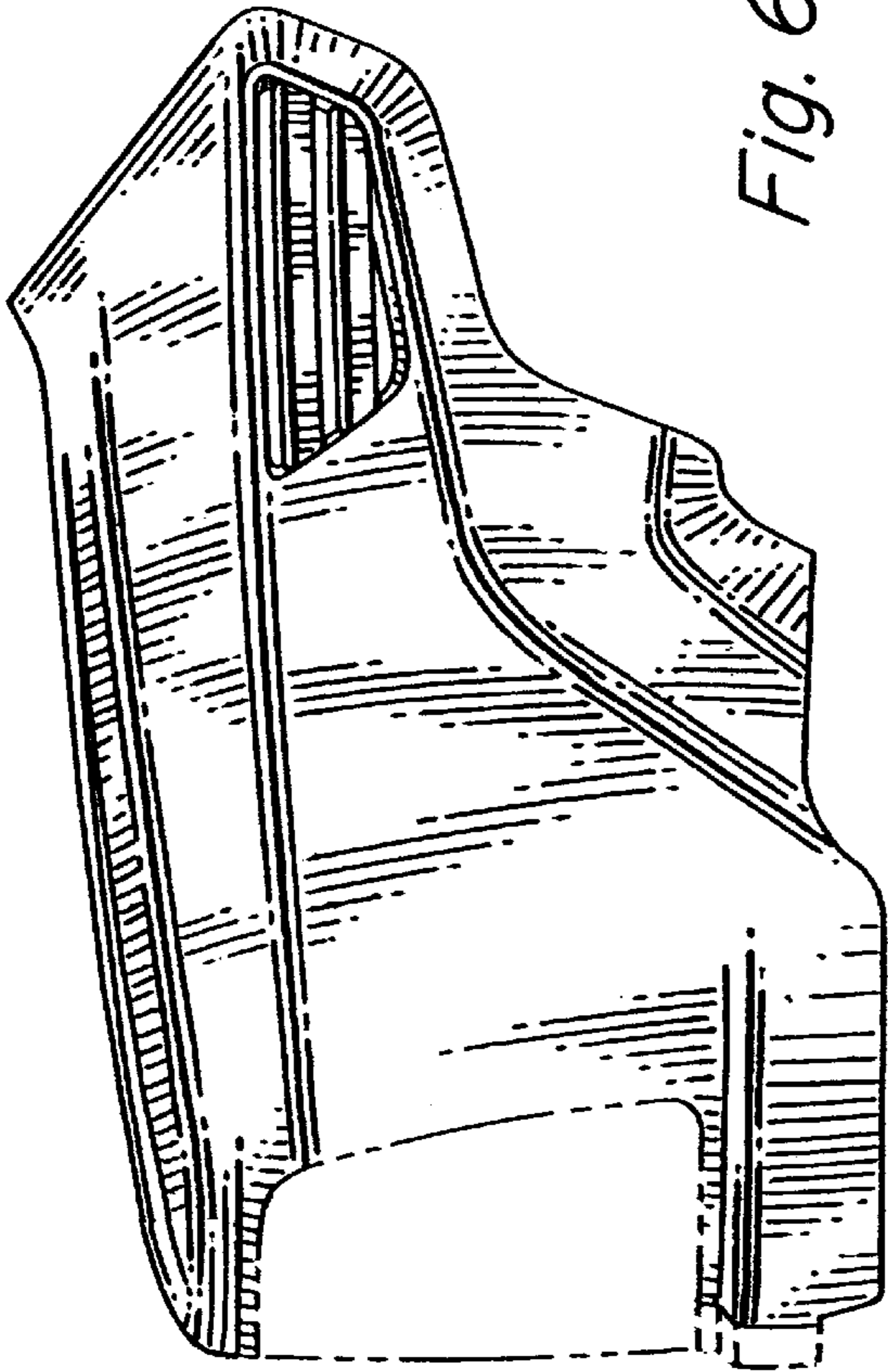

Fig. 6

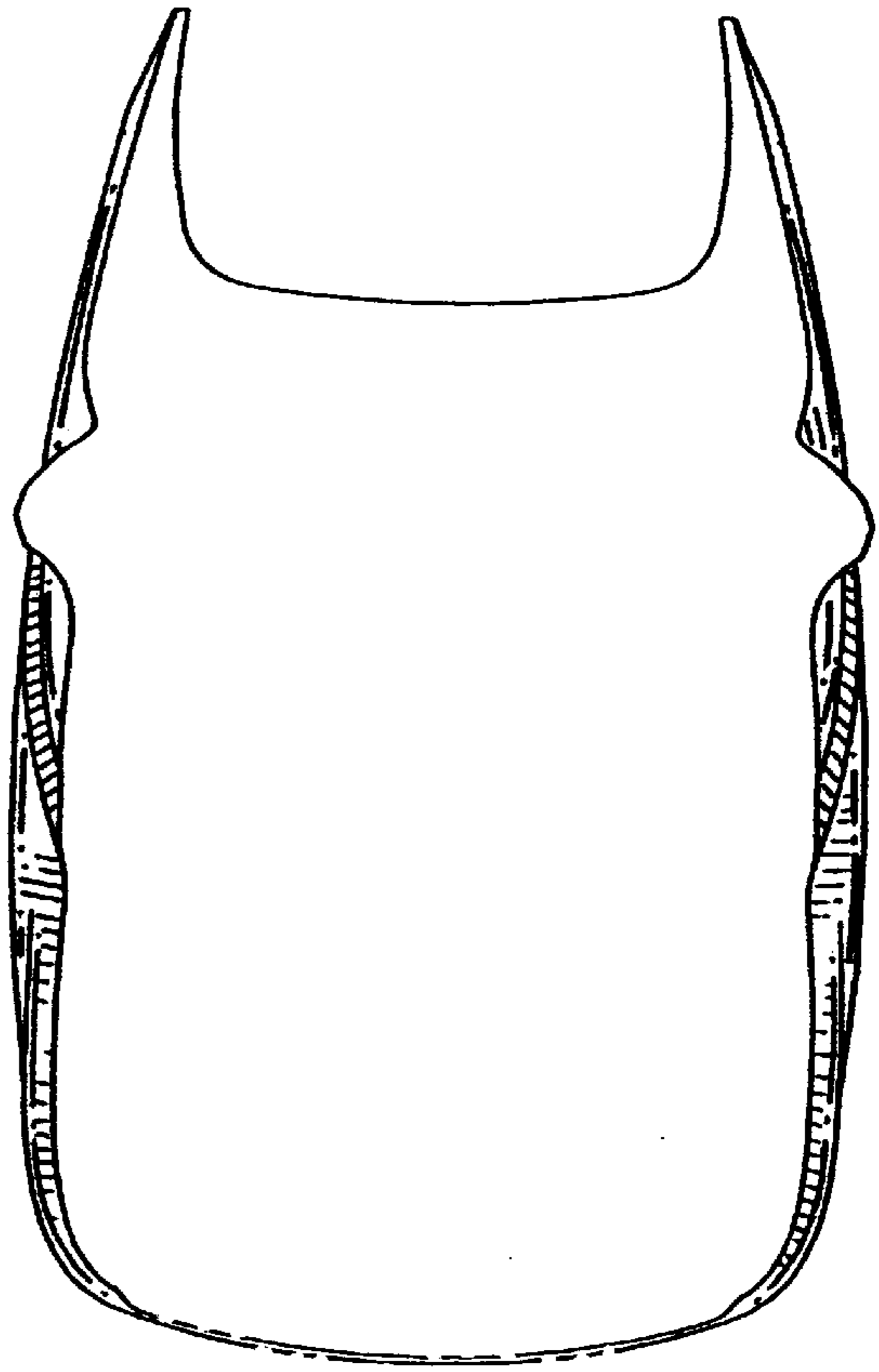

Fig. 8