



US00D448011B1

(12) **United States Design Patent**
Danner et al.

(10) **Patent No.:** **US D448,011 S**

(45) **Date of Patent:** **** Sep. 18, 2001**

(54) **GUEST SERVICE SPEAKERPHONE**

(75) Inventors: **Gregory J. Danner**, Urbana; **Bing N. Sun**, Champaign, both of IL (US)

(73) Assignee: **Scitec, Inc.**, Urbana, IL (US)

(**) Term: **14 Years**

(21) Appl. No.: **29/130,684**

(22) Filed: **Oct. 6, 2000**

(51) **LOC (7) Cl.** **14-03**

(52) **U.S. Cl.** **D14/151**

(58) **Field of Search** D14/137, 138,
D14/148, 147, 149-151, 140-142, 240,
241, 329, 330, 130; D13/108; 379/433-436,
419, 420, 428, 440; 348/14.01, 14.02

(56) **References Cited**

U.S. PATENT DOCUMENTS

D. 286,284	*	10/1986	Sasaki et al.	D14/138
D. 291,439	*	8/1987	Wu	D14/151
D. 295,623	*	5/1988	Gilberton	D14/151
D. 298,938	*	12/1988	Morikawa et al.	D14/151
D. 299,459	*	1/1989	Aschauer et al.	D14/151
D. 299,460	*	1/1989	Aschauer et al.	D14/151
D. 308,059	*	5/1990	Desbarats	D14/151
D. 319,826	*	9/1991	Hung	D14/142
D. 319,829	*	9/1991	Wu	D14/151
D. 321,511	*	11/1991	Swarthout et al.	D14/151
D. 321,871	*	11/1991	Ando	D14/151
D. 322,786	*	12/1991	Wu	D14/151
D. 340,054	*	10/1993	Wetzel et al.	D14/151
D. 352,283	*	11/1994	Schmidt	D14/151
D. 366,484	*	1/1996	Levin	D14/151
D. 370,483	*	6/1996	Zeitman	D14/151

D. 372,912	*	8/1996	Yamada	D14/151
D. 375,497	*	11/1996	Kuwajima	D14/151
D. 418,834	*	1/2000	Zeitman	D14/151
D. 426,822	*	6/2000	Jauregui et al.	D14/151
D. 427,174	*	6/2000	Jauregui et al.	D14/151
5,864,619	*	1/1999	Ehara	379/435

* cited by examiner

Primary Examiner—Jeffrey Asch

(74) *Attorney, Agent, or Firm*—Welsh & Katz, Ltd.

(57) **CLAIM**

The ornamental design for a guest service speakerphone, as shown and described.

DESCRIPTION

FIG. 1 is a perspective view of a guest service speakerphone of the claimed design;
 FIG. 2 is an end view of the guest service speakerphone of FIG. 1;
 FIG. 3 is a right-hand side view of the guest service speakerphone of FIG. 1;
 FIG. 4 is an end view of the guest service speakerphone of FIG. 1, showing the opposite end as shown in FIG. 2;
 FIG. 5 is a left-hand side view of the guest service speakerphone of FIG. 1;
 FIG. 6 is a top view of the guest service speakerphone of FIG. 1;
 FIG. 7 is a bottom view of the guest service speakerphone of FIG. 1; and,
 FIG. 8 is a perspective view of the guest service speakerphone of FIG. 1 showing the handset lifted from its cradle. The broken line showings of the telephone cord in FIGS. 1 and 8 are for illustrative purposes only and form no part of the claimed design.

1 Claim, 6 Drawing Sheets

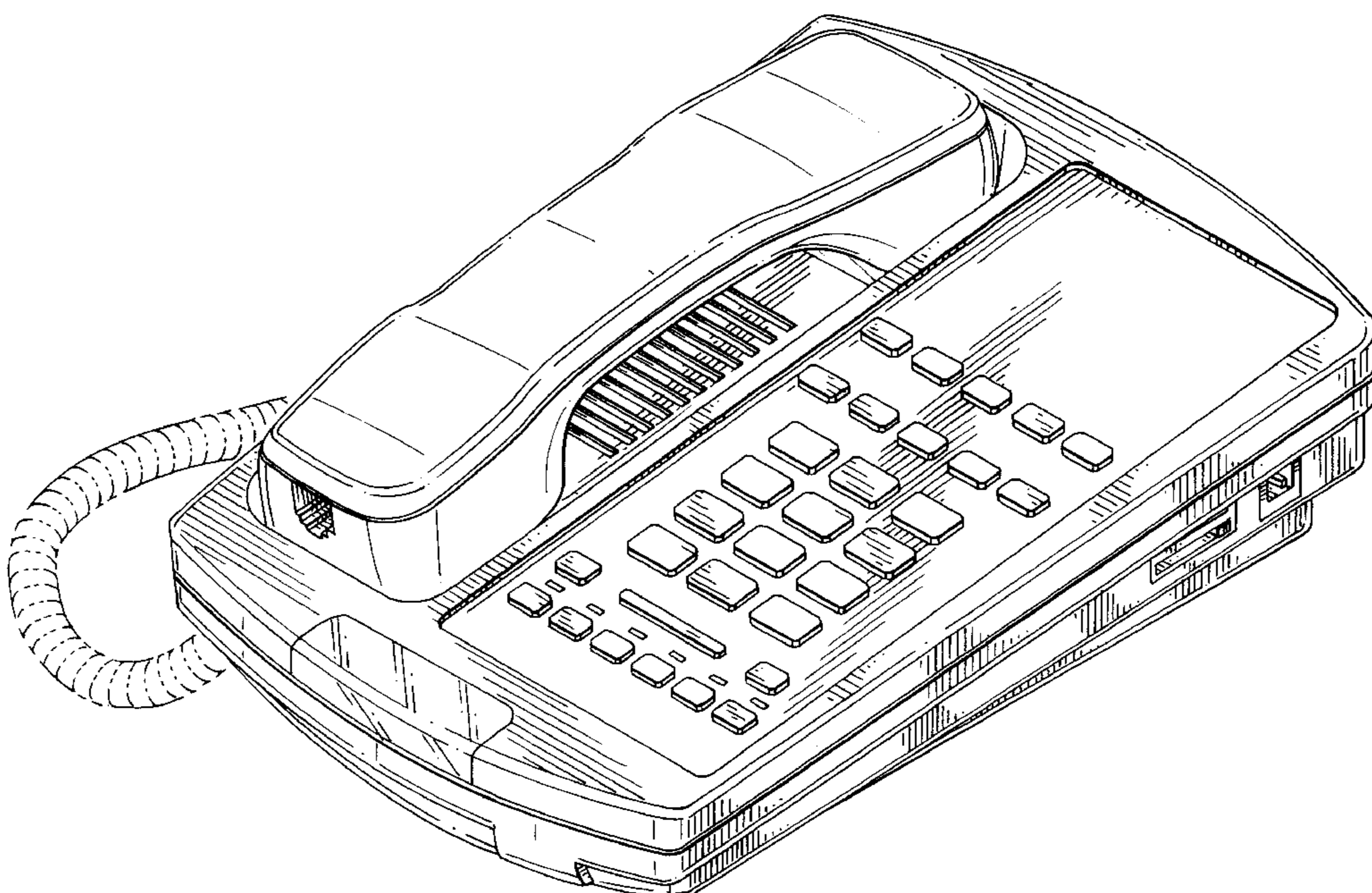

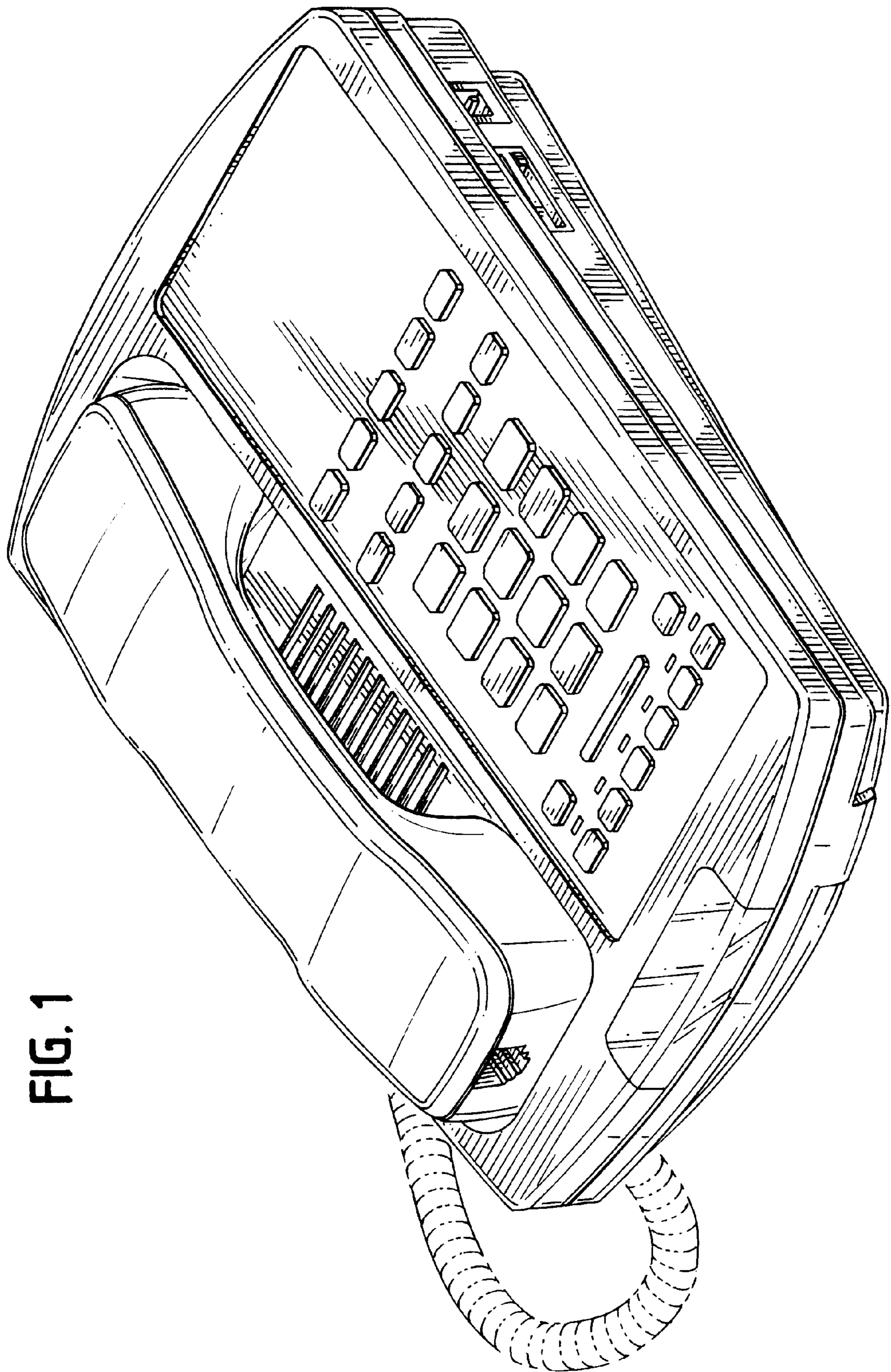

FIG. 1

FIG. 2

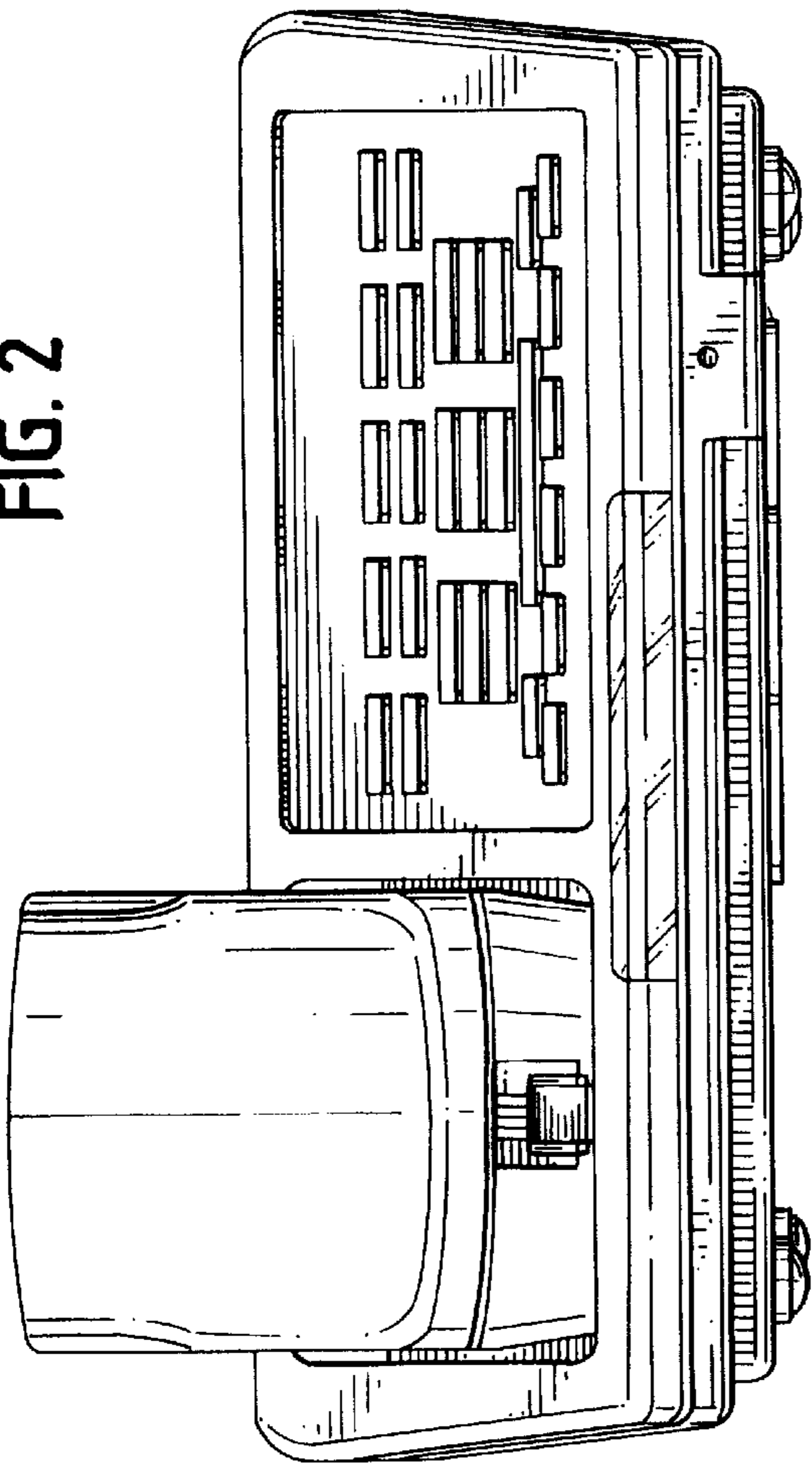
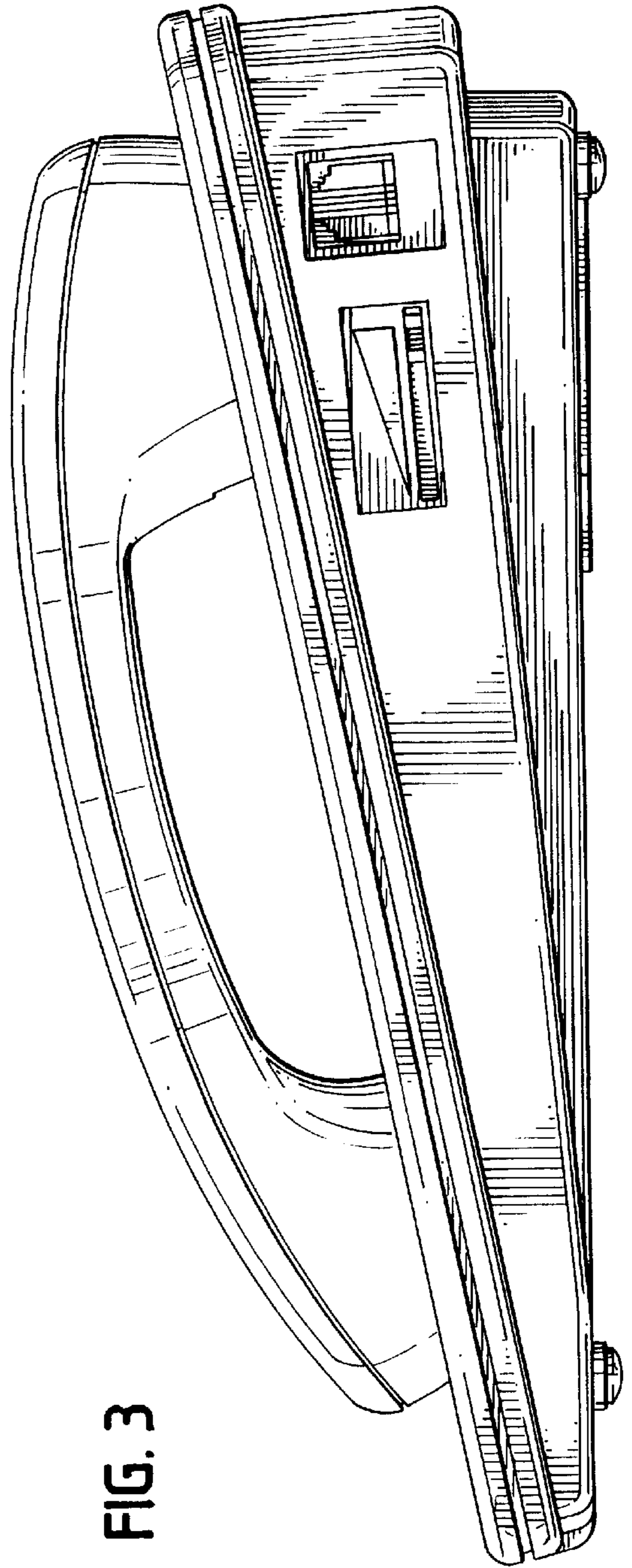

FIG. 3



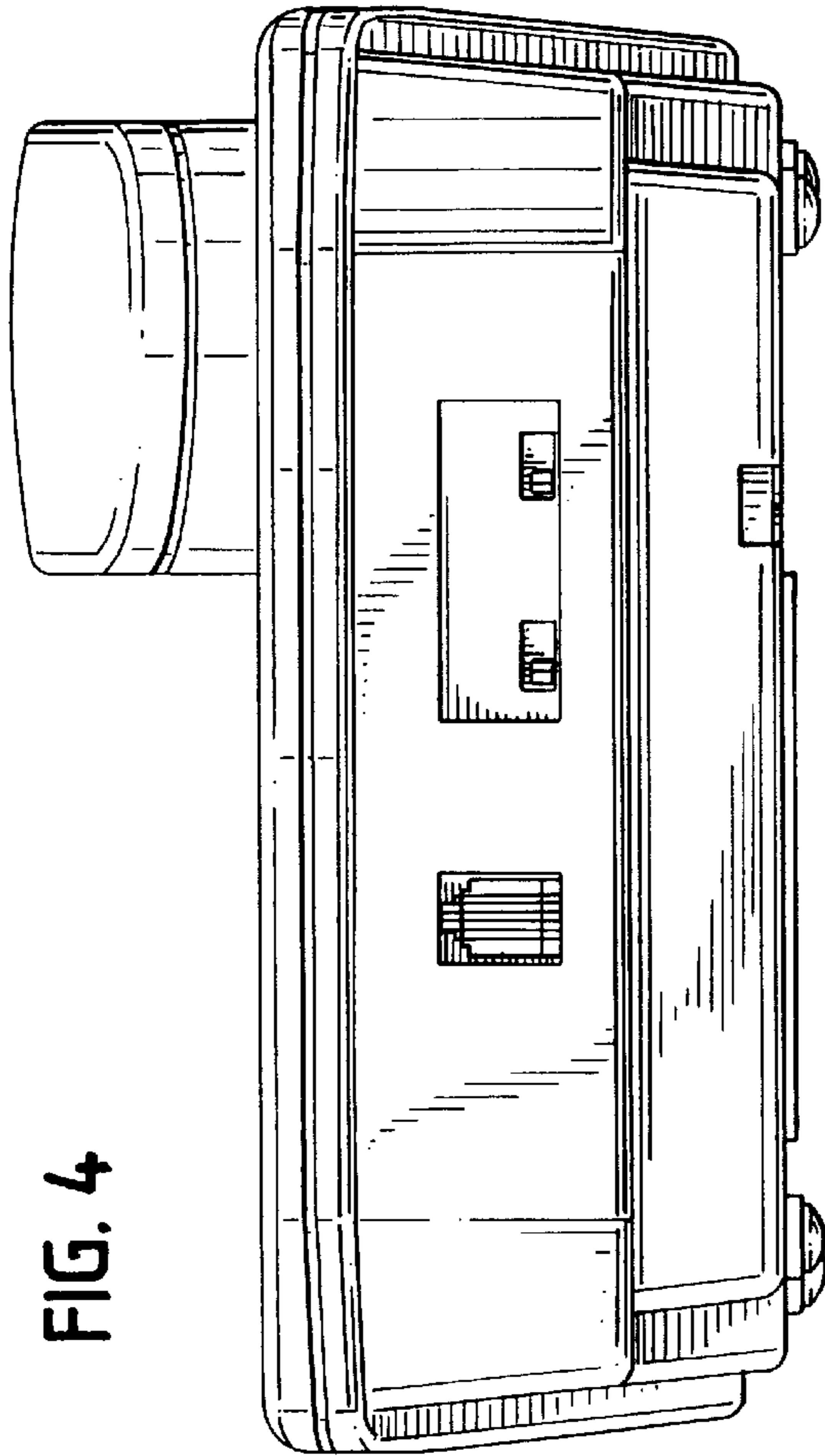

FIG. 4

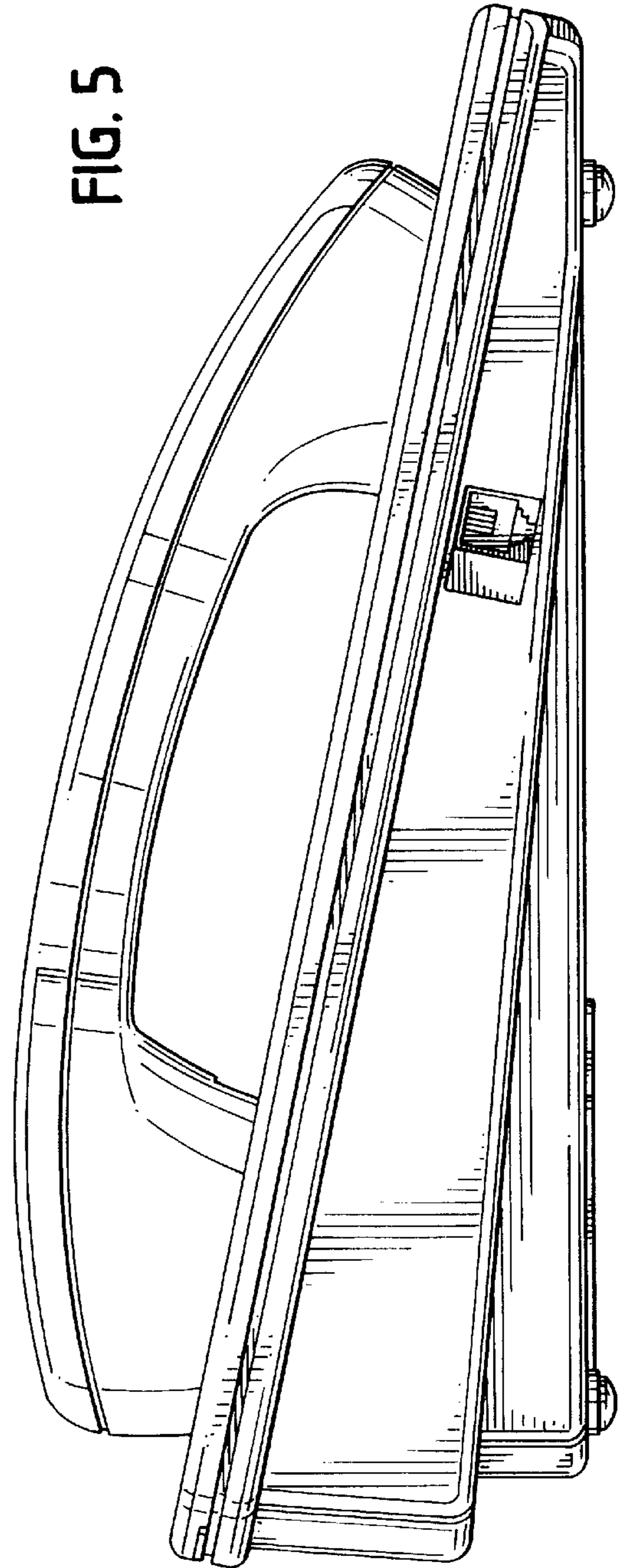

FIG. 5

FIG. 6

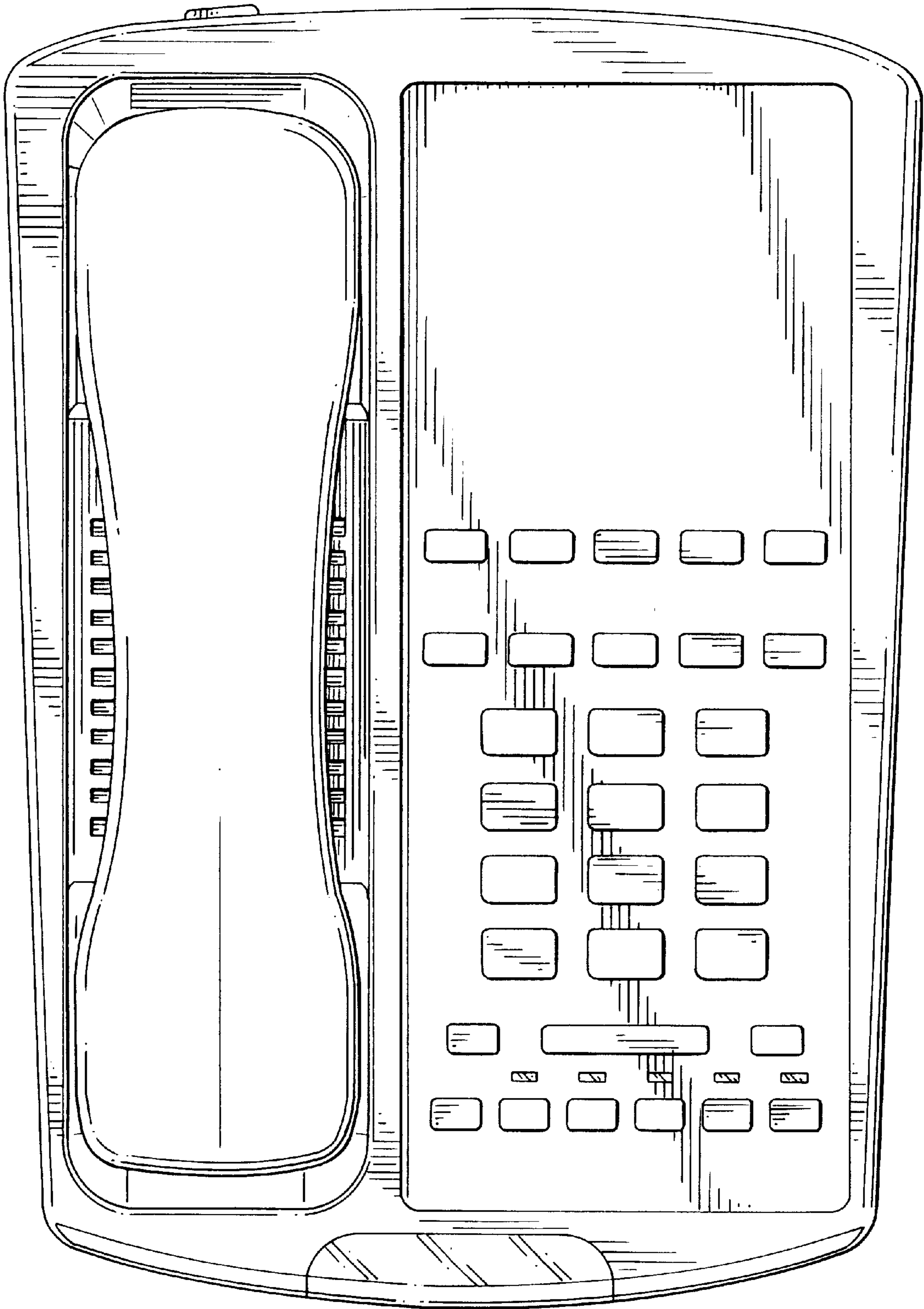

FIG. 7

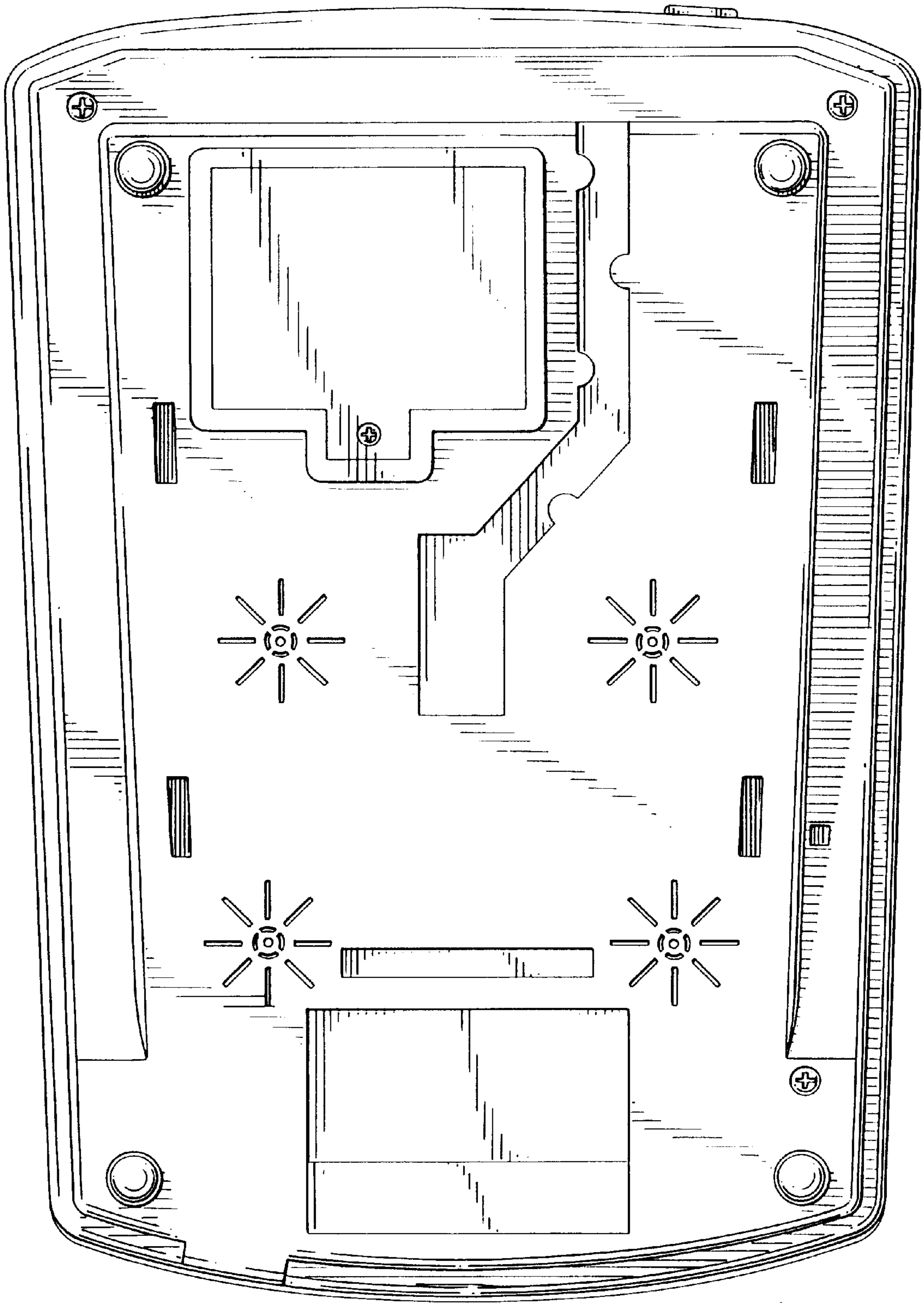

FIG. 8

