



US00D447937B1

(12) **United States Design Patent**
Tsuruishi et al.

(10) **Patent No.:** **US D447,937 S**

(45) **Date of Patent:** **** Sep. 18, 2001**

(54) **PACKAGING BOX**

(75) Inventors: **Hideaki Tsuruishi**, Yokohama; **Keita Yoshida**, Tokyo; **Tomomi Yoshida**, Yokohama, all of (JP)

(73) Assignee: **Canon Kabushiki Kaisha**, Tokyo (JP)

(**) Term: **14 Years**

(21) Appl. No.: **29/126,487**

(22) Filed: **Jul. 19, 2000**

(30) **Foreign Application Priority Data**

Feb. 3, 2000 (JP) 12-005169

(51) **LOC (7) Cl.** **09-03**

(52) **U.S. Cl.** **D9/415; D9/434**

(58) **Field of Search** D9/415, 414, 456,
D9/457, 499, 434; 206/461-471, 806, 279,
527, 813; 248/214, 215, 205.3, 220.21,
683, 690-692

(56) **References Cited**

U.S. PATENT DOCUMENTS

- D. 243,443 * 2/1977 Hayashi D9/415
- D. 420,905 * 2/2000 Adkins D9/415
- D. 430,487 * 9/2000 Prochaska D9/415

- 3,467,248 * 9/1969 Makowicki 206/462
- 4,261,462 * 4/1981 Wysocki 206/462
- 5,353,935 * 10/1994 Yeager et al. 206/470
- 6,016,914 * 1/2000 Gustafson 206/470
- 6,050,415 * 4/2000 Lind et al. 206/462

* cited by examiner

Primary Examiner—Prabhakar Deshmukh

(74) *Attorney, Agent, or Firm*—Fitzpatrick, Cella, Harper, & Scinto

(57) **CLAIM**

The ornamental design for a packaging box, as shown and described.

DESCRIPTION

FIG. 1 is a front view of a packaging box showing our new design;

FIG. 2 is a rear view thereof;

FIG. 3 is a top plan view thereof;

FIG. 4 is a bottom plan view thereof;

FIG. 5 is a left side view thereof;

FIG. 6 is a right side view thereof; and,

FIG. 7 is a perspective view as viewed from right and front thereof.

The broken lines are for illustrative purpose only and forms no part of the claimed design.

1 Claim, 4 Drawing Sheets

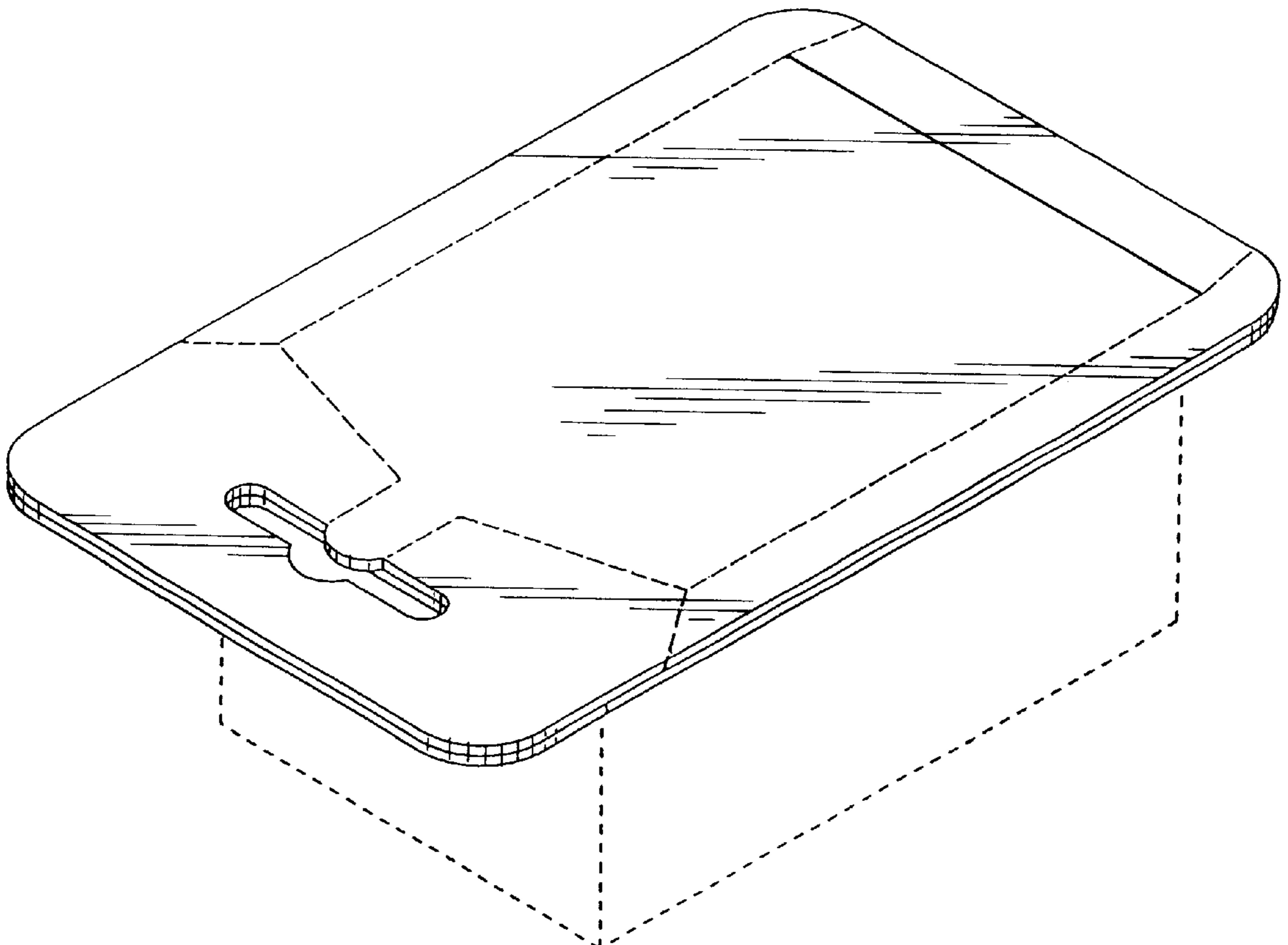

FIG. 1

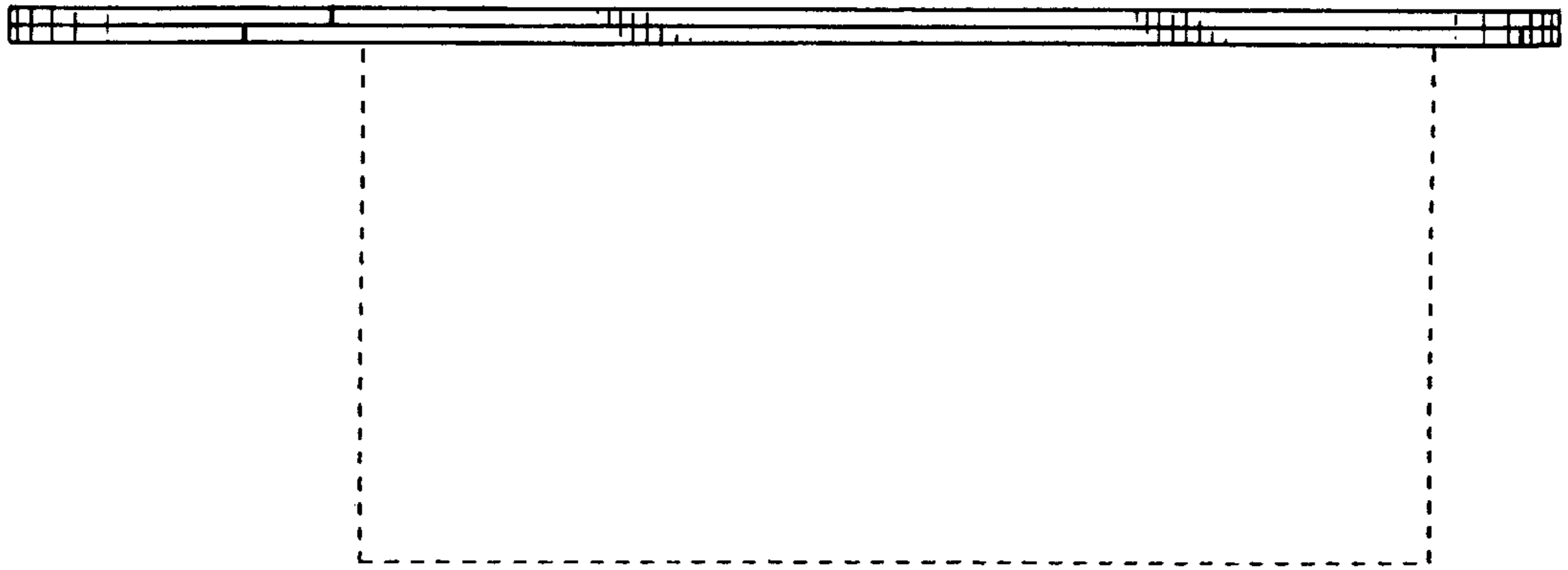

FIG. 2

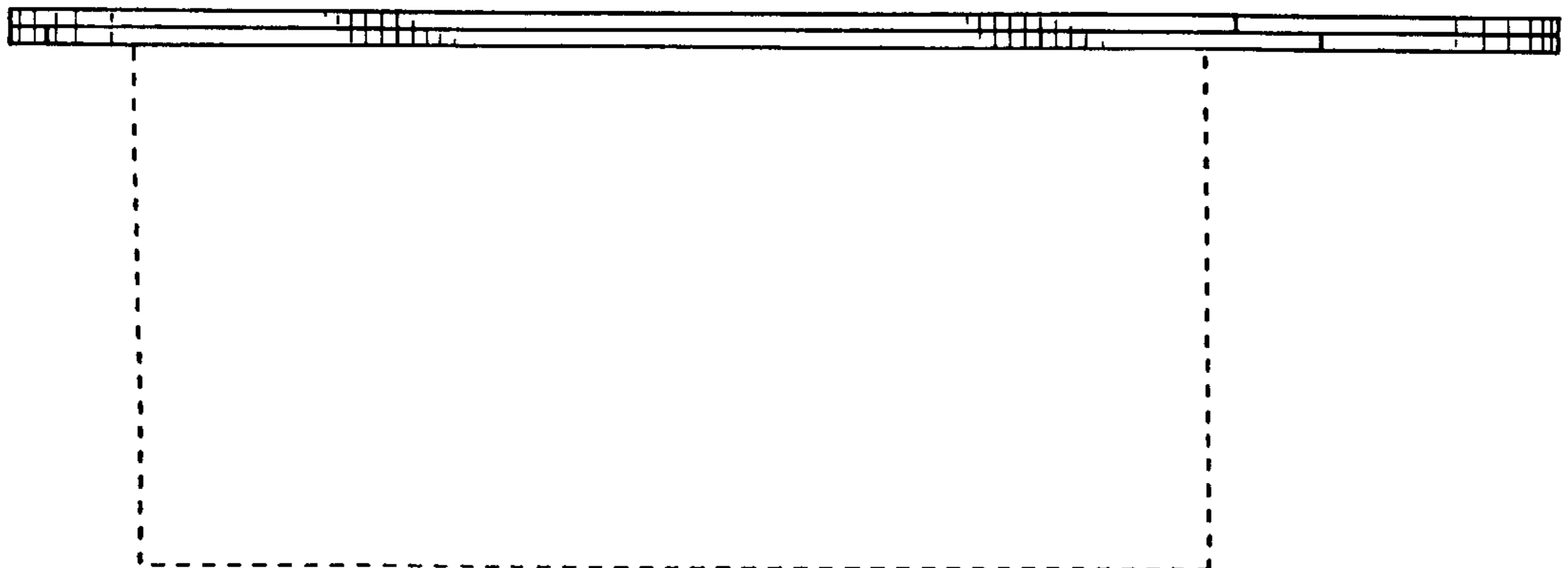

FIG. 3

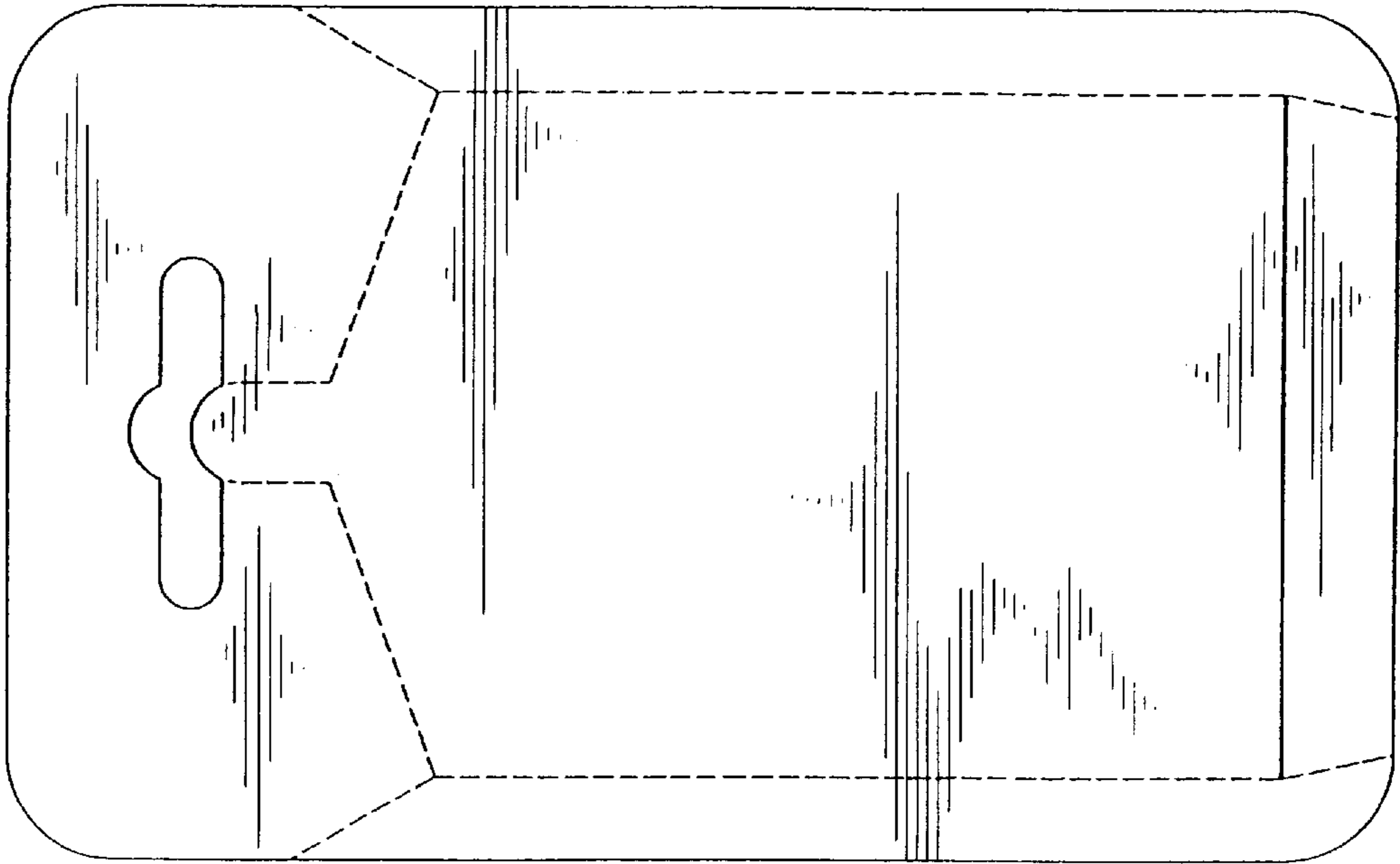

FIG. 4

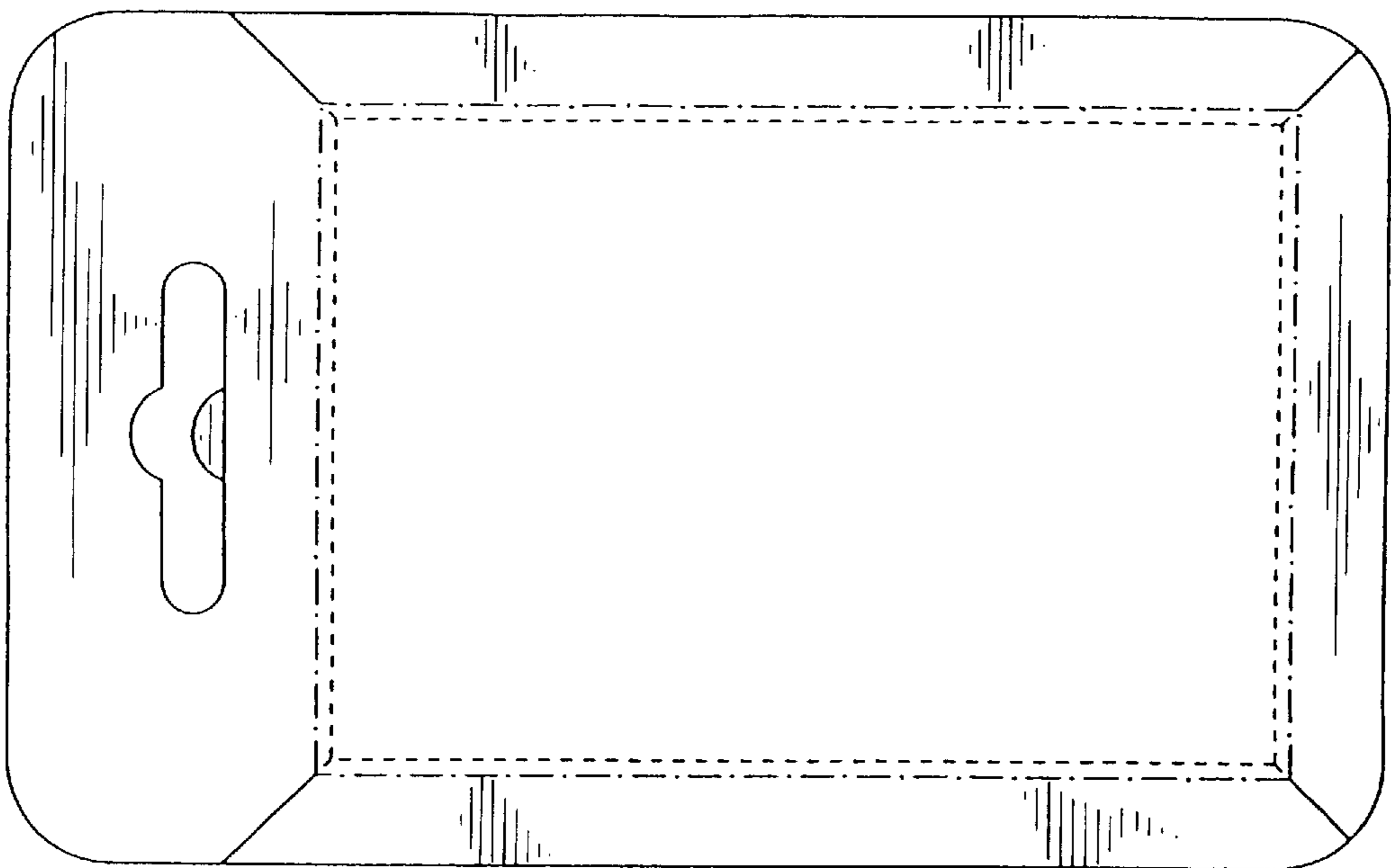

FIG. 5

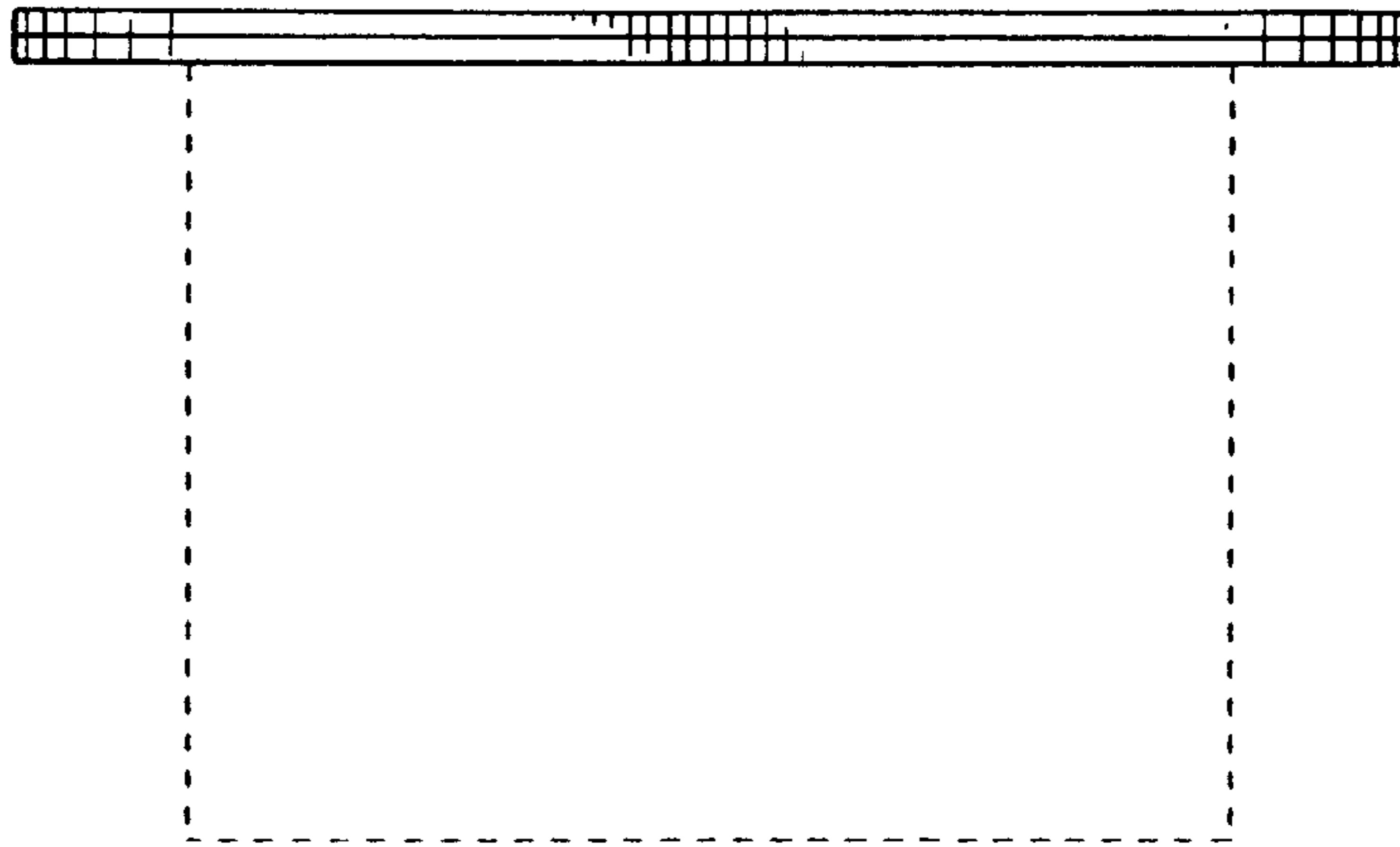

FIG. 6

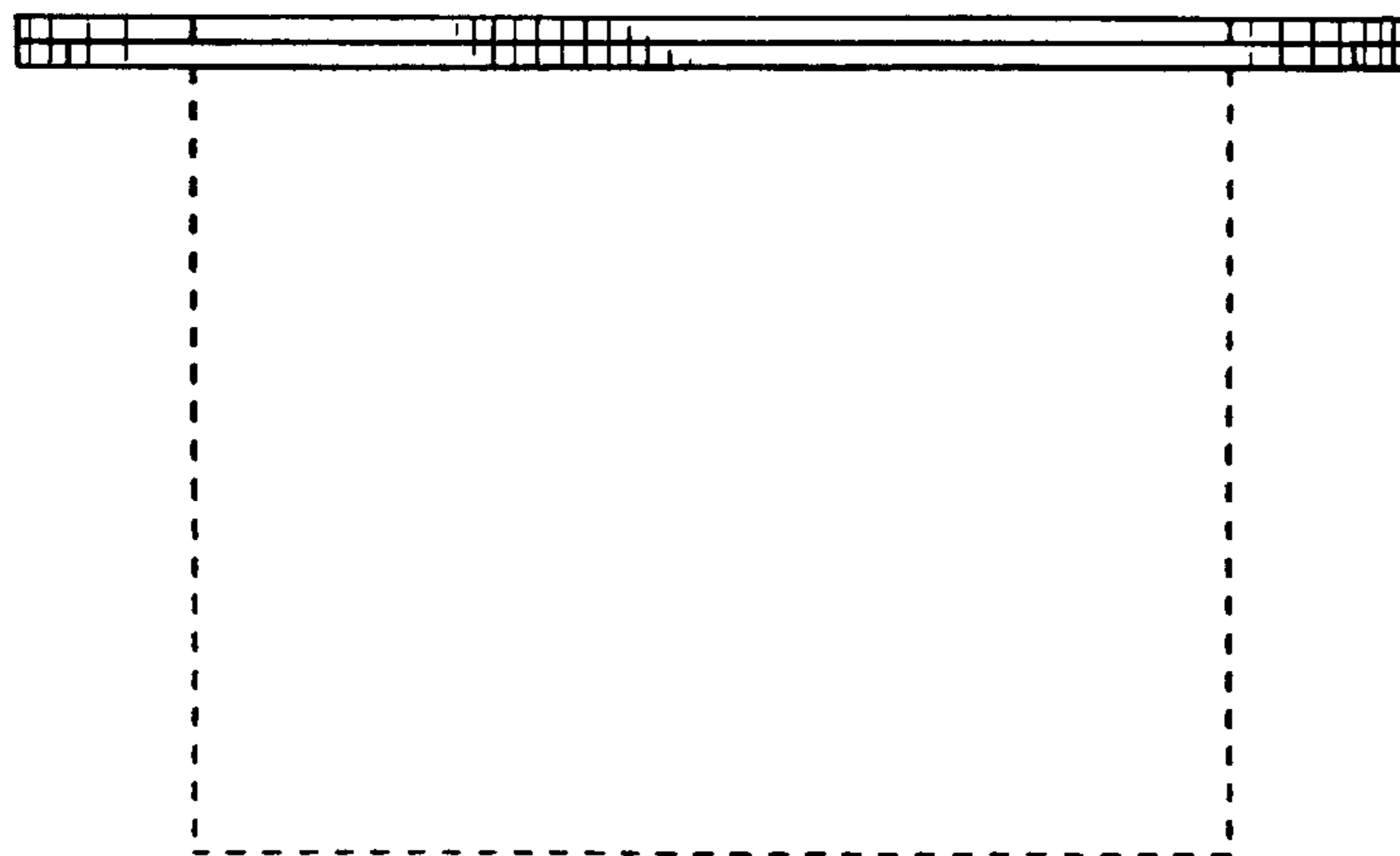

FIG. 7

