



US00D447787B1

(12) **United States Design Patent**
Smith et al.

(10) **Patent No.:** **US D447,787 S**

(45) **Date of Patent:** **** Sep. 11, 2001**

(54) **FISHING REEL**

OTHER PUBLICATIONS

(75) Inventors: **M. Scott Smith**, Broken Arrow; **Kent Zwyer**, Tulsa, both of OK (US)

Bass Pro Shops, Citica/Tourney Special Combo Baitcasting Reel, p. 41, 1996.*

(73) Assignee: **Brunswick Corporation**, Tulsa, OK (US)

* cited by examiner

(**) Term: **14 Years**

Primary Examiner—Catherine R. Oliver
(74) *Attorney, Agent, or Firm*—Wood, Phillips, VanSanten, Clark & Mortimer

(21) Appl. No.: **29/125,517**

(57) **CLAIM**

(22) Filed: **Jun. 26, 2000**

The ornamental design for a fishing reel, as shown and described.

(51) **LOC (7) Cl.** **22-05**

(52) **U.S. Cl.** **D22/140**

(58) **Field of Search** D22/137, 140,
D22/141; 242/310, 311, 312, 314, 323,
223

DESCRIPTION

(56) **References Cited**

U.S. PATENT DOCUMENTS

D. 346,006	*	4/1994	Sakurai et al.	D22/140
D. 380,521	*	7/1997	Robbins	D22/141
D. 404,109	*	1/1999	Zwyer et al.	D22/141
2,929,578	*	3/1960	Hull	242/311
5,988,548	*	11/1999	Chapman et al.	242/310

FIG. 1 is a top, side, and rear perspective view of the fishing reel showing our new design;
FIG. 2 is an elevation view thereof from the side opposite that in FIG. 1;
FIG. 3 is an elevation view thereof from the same side as FIG. 1;
FIG. 4 is a plan view thereof;
FIG. 5 is a bottom view thereof;
FIG. 6 is a front elevation view thereof; and,
FIG. 7 is a rear elevation view thereof.

1 Claim, 4 Drawing Sheets

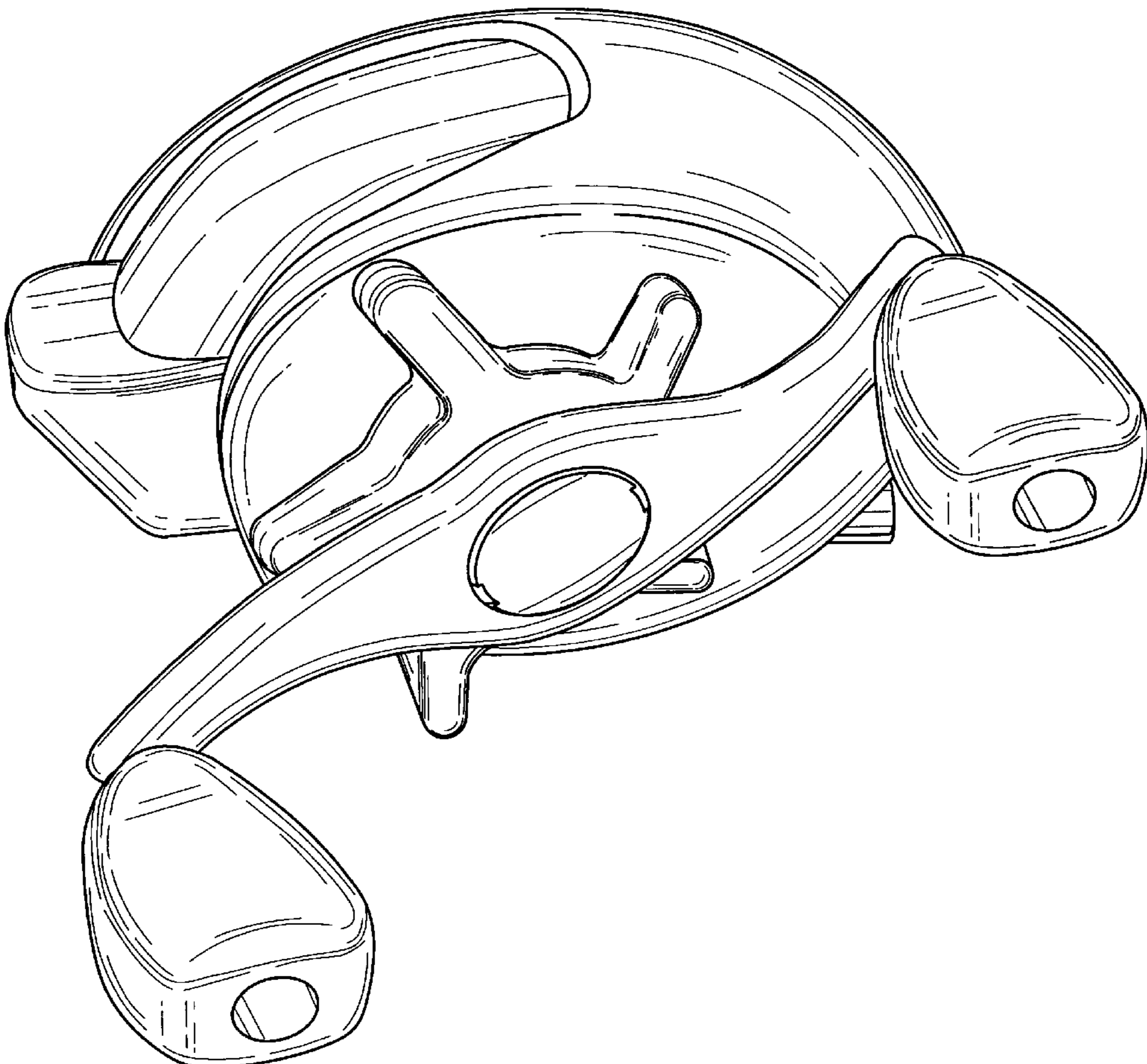

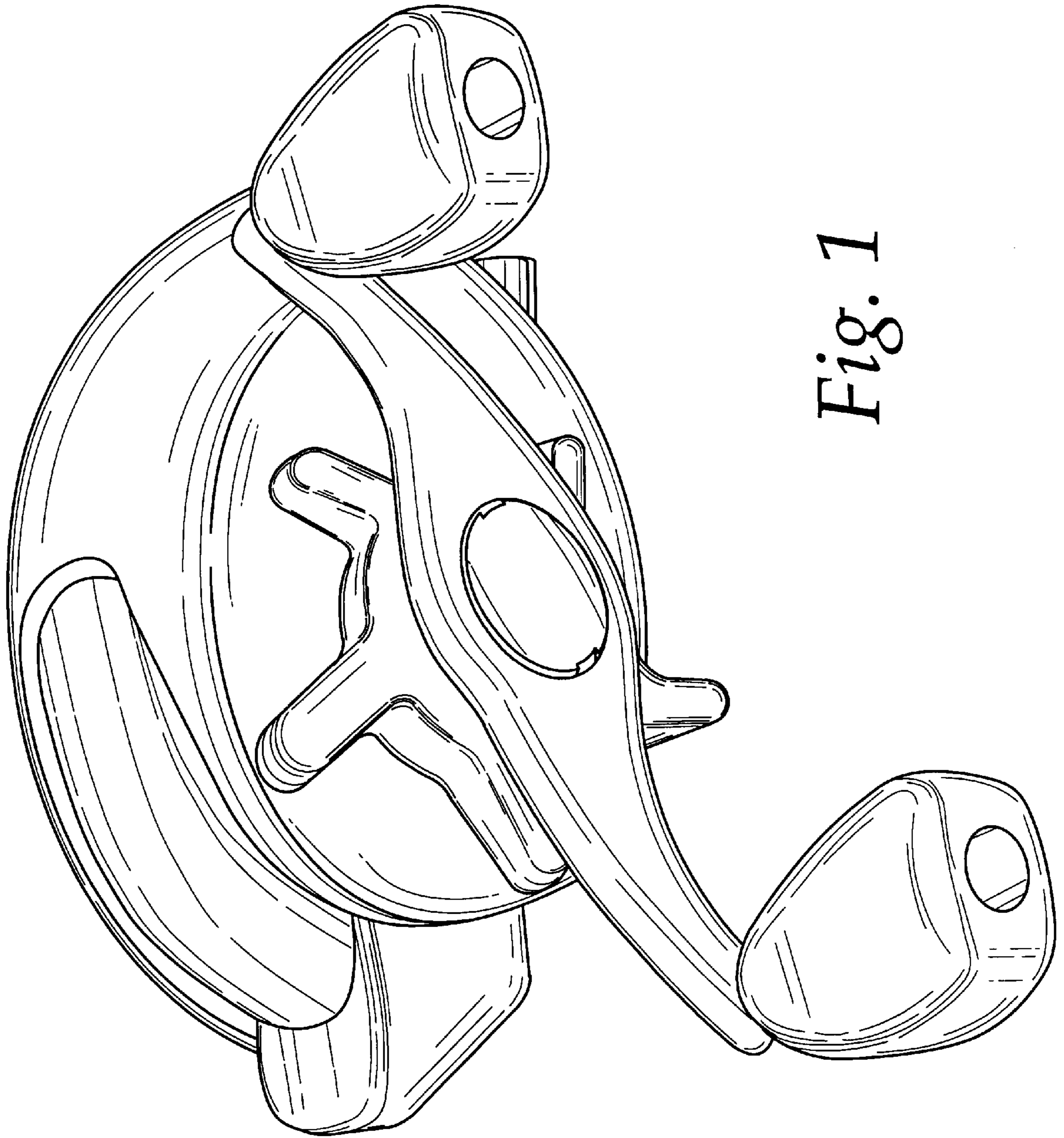

Fig. 1

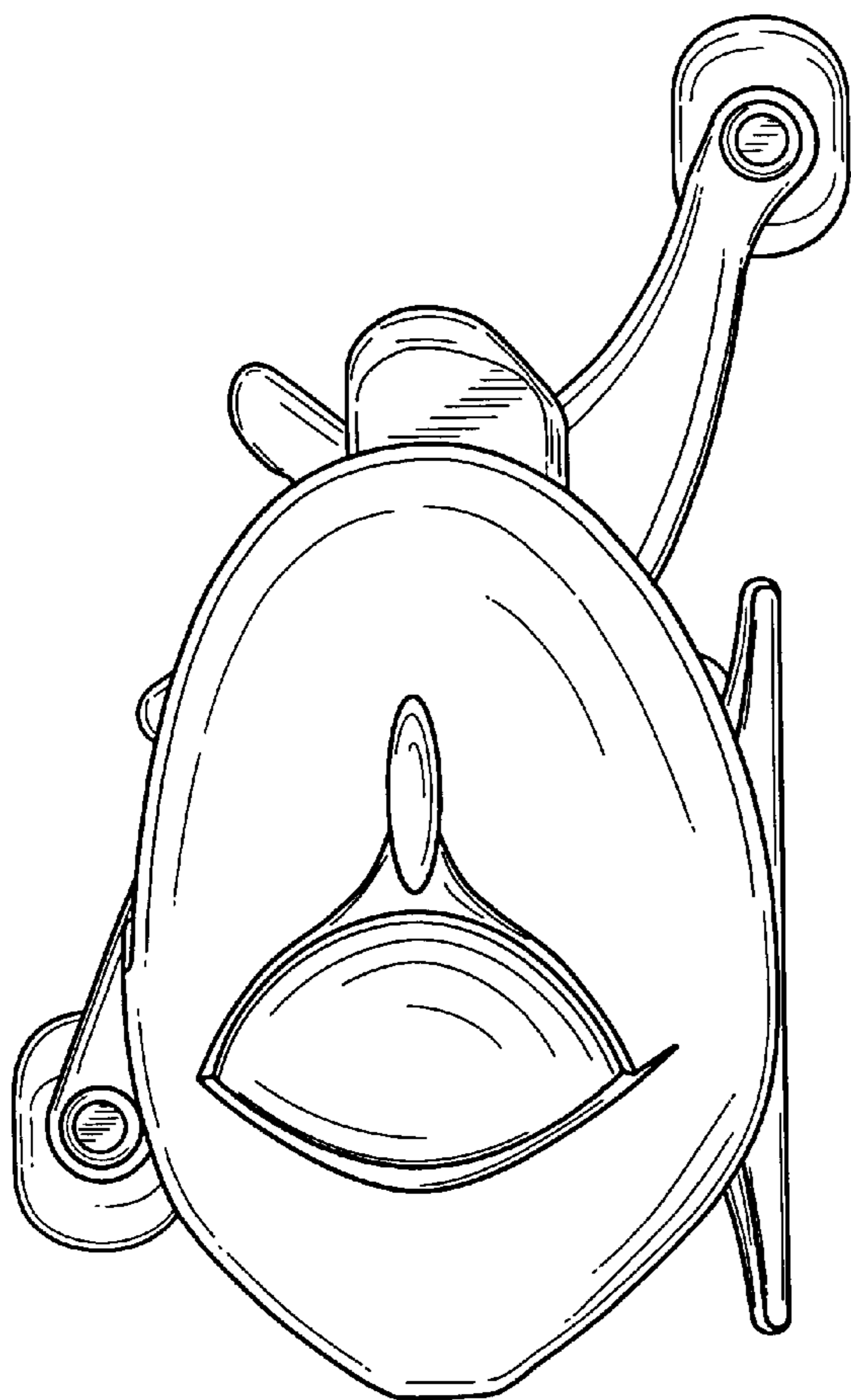

Fig. 2

Fig. 3

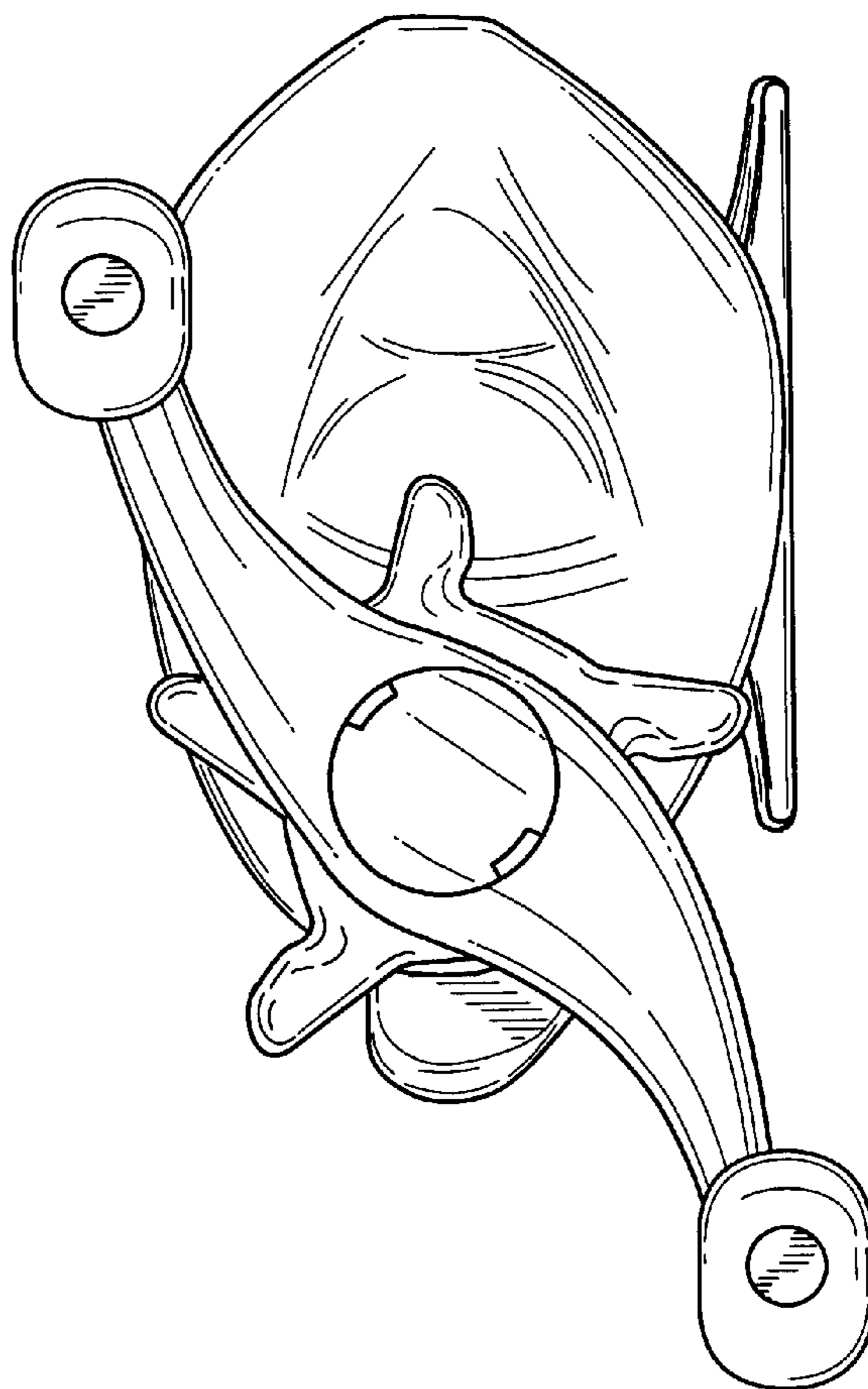

Fig. 5

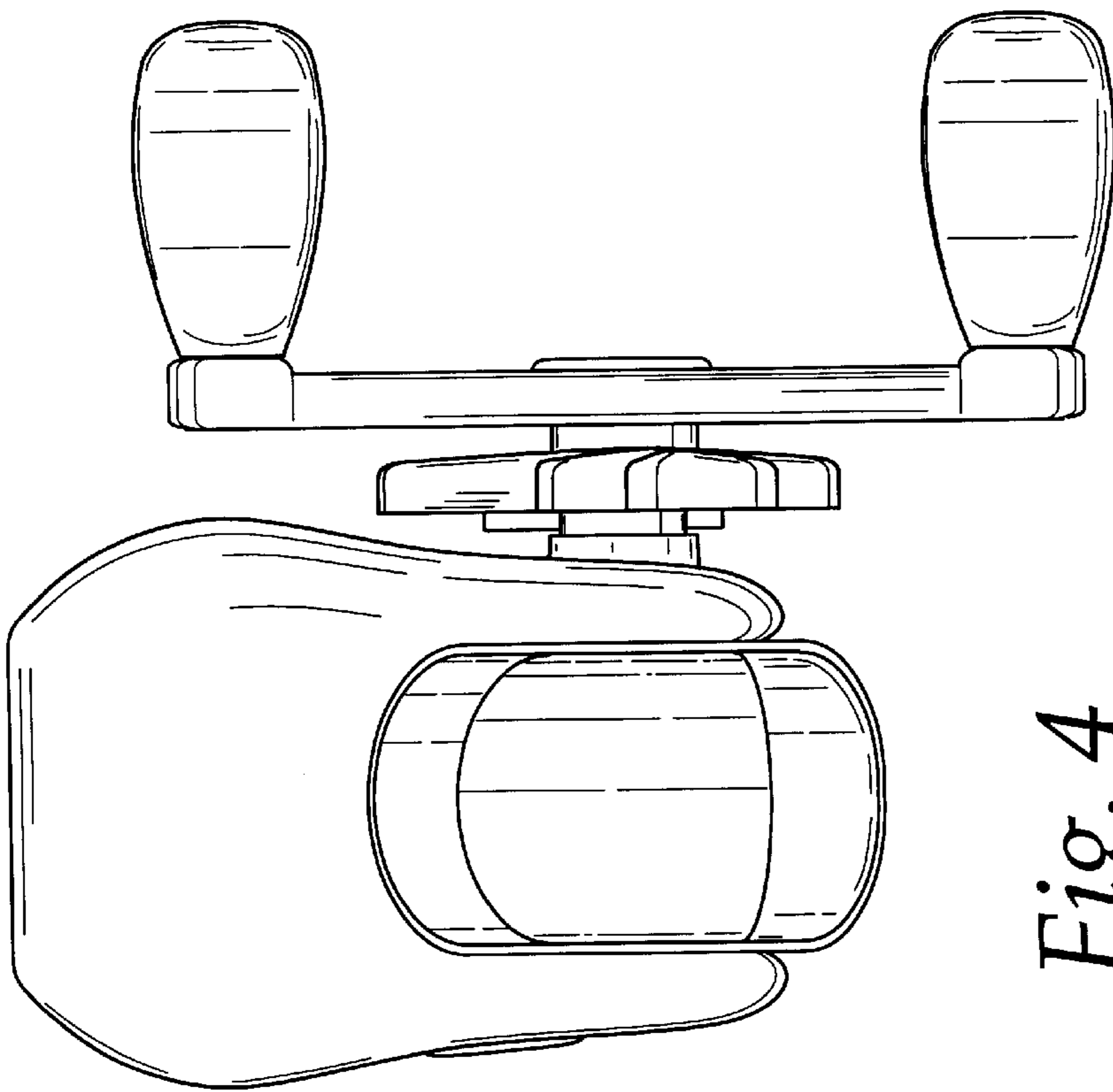
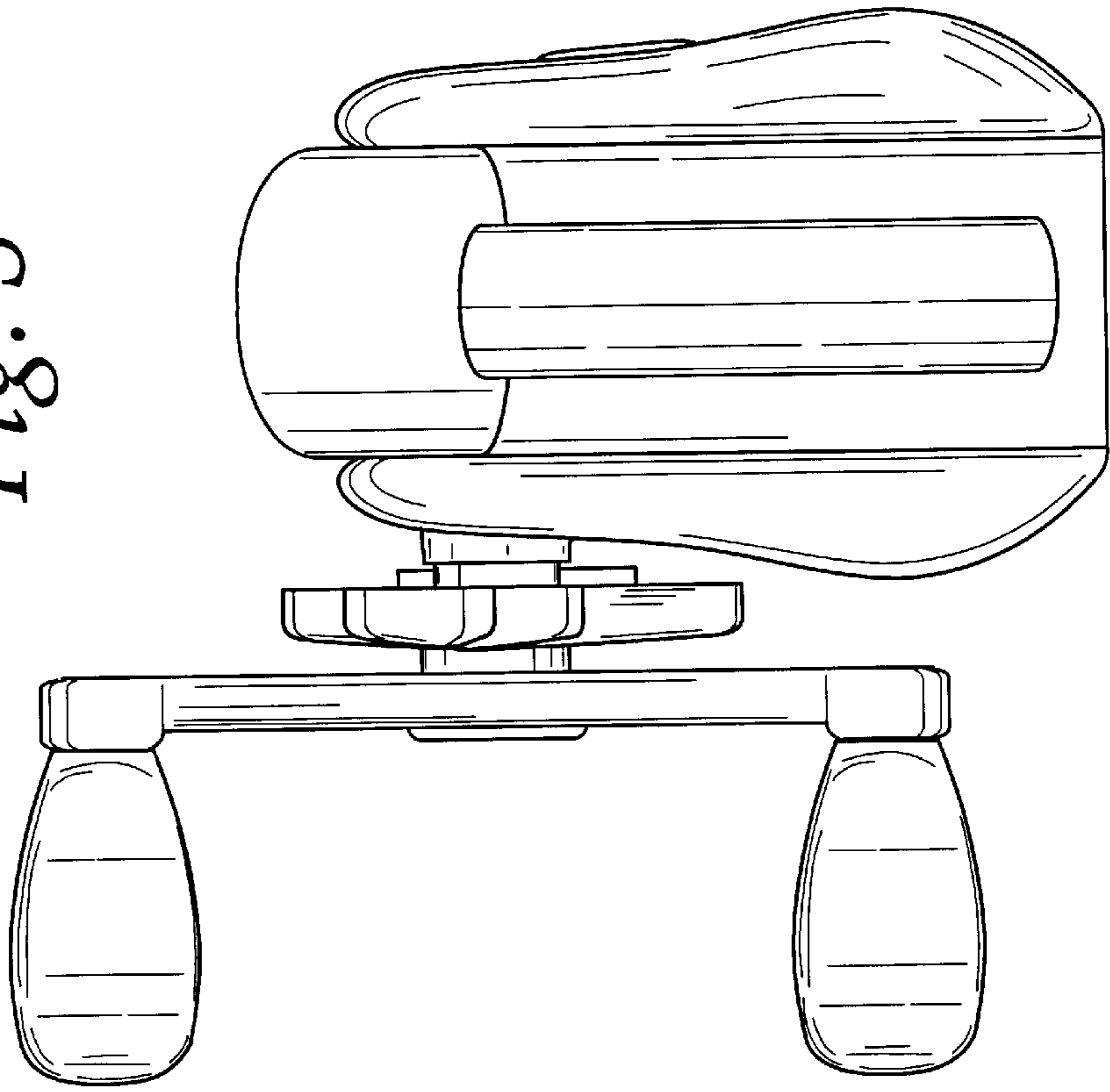

Fig. 4

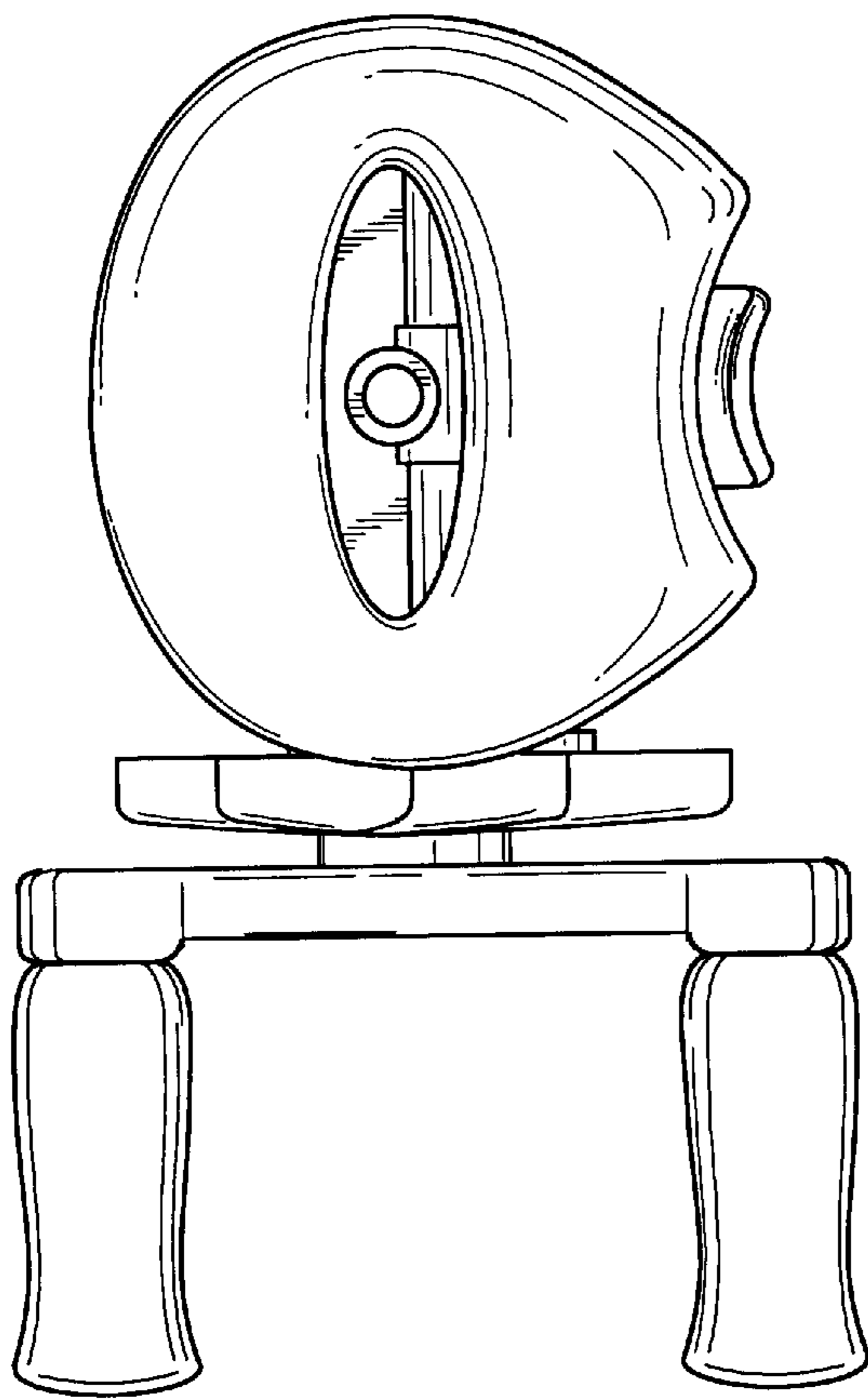

Fig. 6

Fig. 7

