



US00D447763B1

(12) **United States Design Patent**  
**Lane**

(10) **Patent No.: US D447,763 S**

(45) **Date of Patent: \*\* Sep. 11, 2001**

(54) **EYEGLASSES**

(75) **Inventor: Henry Welling Lane, San Luis Obispo, CA (US)**

(73) **Assignee: Dioptics Medical Products, Inc., San Luis Obispo, CA (US)**

(\*\*) **Term: 14 Years**

(21) **Appl. No.: 29/135,902**

(22) **Filed: Jan. 19, 2001**

(51) **LOC (7) Cl. .... 16-06**

(52) **U.S. Cl. .... D16/315**

(58) **Field of Search .... D16/101, 300-330, D16/335; D29/109, 110; 351/41, 44, 51, 52, 103, 109, 111, 158; 2/447, 448**

(56) **References Cited**

**U.S. PATENT DOCUMENTS**

D. 104,320	4/1937	Bouchard .	
D. 112,976	1/1939	Brunetti .	
D. 112,989	1/1939	Diodati .	
D. 166,578 *	4/1952	Splaine .....	D16/335
D. 191,229	8/1961	Boxer .....	D57/1
D. 195,311	5/1963	McNeill .....	D57/1
D. 201,920	8/1965	McCulloch .....	D57/1
D. 204,163	3/1966	Mitchell .....	D57/1
D. 204,320	4/1966	Carmichael .....	D57/1
D. 204,498	4/1966	Mitchell .....	D57/1
D. 204,816	5/1966	Boxer .....	D57/1
D. 205,246	7/1966	Mitchell .....	D57/1
D. 210,423	3/1968	Mitchell .....	D57/1
D. 212,198	9/1968	Bloch .....	D57/1
D. 220,291	3/1971	Bloch .....	D57/1
D. 235,164	5/1975	Shindler .....	D57/1 A
D. 270,165	8/1983	Burns .....	D16/117
D. 274,437	6/1984	Dianitsch .....	D16/110
D. 279,904 *	7/1985	Pulie .....	D16/325
D. 284,769	7/1986	MacWilliamson .....	D16/118
D. 285,020	8/1986	Schmidthaler .....	D2/234
D. 293,328	12/1987	Murphy et al. ....	D14/102
D. 293,450	12/1987	Jannard .....	D16/102
D. 294,833	3/1988	Holden .....	D16/112

D. 295,286	4/1988	Takeuchi .....	D16/110
D. 295,533	5/1988	Wichers .....	D16/102
D. 295,870	5/1988	Laterre .....	D16/112

(List continued on next page.)

**FOREIGN PATENT DOCUMENTS**

124450	8/1995	(AU) .
127863	9/1996	(AU) .
1185637	10/1957	(FR) .

**OTHER PUBLICATIONS**

Visionworks Catalog, P,21, 1990.\*  
 Giorgio Armani, P13, 1995.\*  
 Guild Guide, P9, Sep. 1972.\*  
 Solarshields Advertisement in Parade Magazine, Washington Post, May 10, 1992.  
 Bollé Polarisant Collection, 1993 Catalog.  
 Fisherman Eyewear, 1996 Catalog.  
 Fisherman Eyewear, 1997 Catalog.  
 Costa Del Mar, 1997 Catalog.  
 Hobie Polarized Sunglasses, 1997 Catalog.  
 Ocean Waves Advertisement, no date.  
 USA Sport Advertisement for Adjustable Deluxe Series, no date.

*Primary Examiner*—Raphael Barkai  
 (74) *Attorney, Agent, or Firm*—Haverstock & Owens LLP

(57) **CLAIM**

I claim the ornamental design for eyeglasses, as shown and described.

**DESCRIPTION**

FIG. 1 is a top perspective view of eyeglasses showing of my new design;  
 FIG. 2 is a front elevation view of eyeglasses thereof;  
 FIG. 3 is a rear elevation view of eyeglasses thereof;  
 FIG. 4 is a top view of eyeglasses thereof;  
 FIG. 5 is a bottom view of eyeglasses thereof; and,  
 FIG. 6 is a right side elevation view of eyeglasses thereof, the left side being a mirror image of the right side.

**1 Claim, 5 Drawing Sheets**

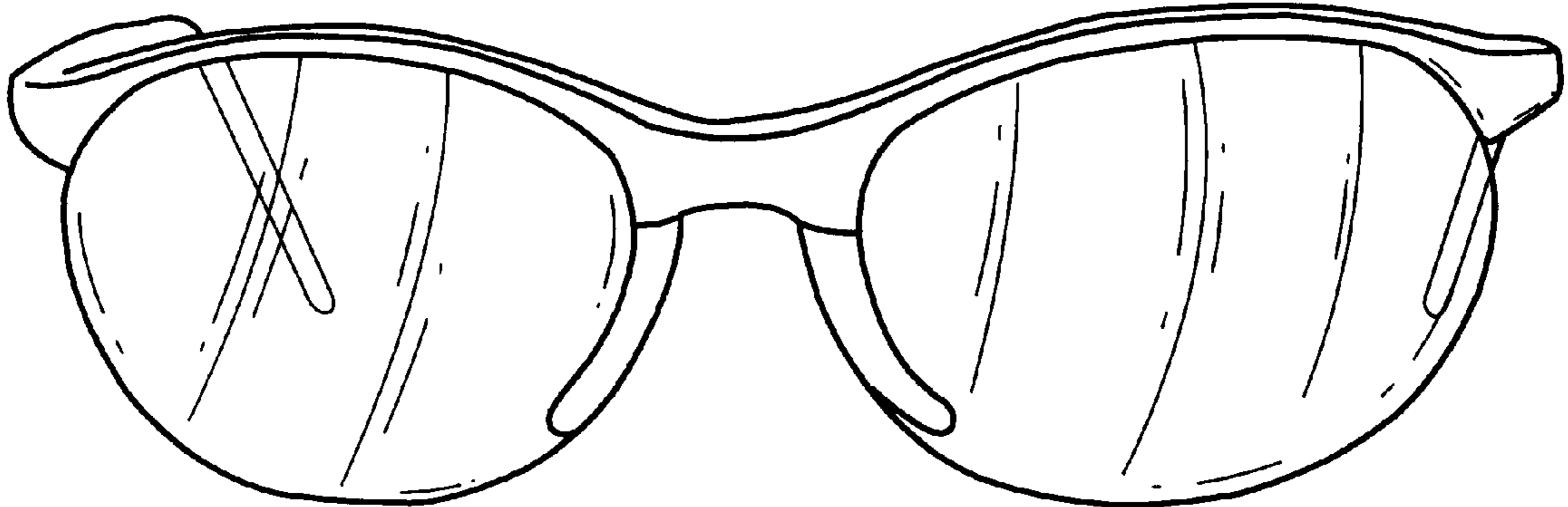

# US D447,763 S

Page 2

## U.S. PATENT DOCUMENTS

D. 308,980	7/1990	McGee .....	D16/112	D. 434,789	12/2000	Lane .....	D16/326
D. 313,236	12/1990	Mackay .....	D16/102	D. 435,579	12/2000	Lane .....	D16/327
D. 317,771	6/1991	Mackay .....	D16/102	2,300,365	10/1942	Wagner .....	2/14
D. 323,335	1/1992	Dalloz .....	D16/112	3,233,249	2/1966	Baratelli et al. ....	2/14
D. 323,515	1/1992	Arbez .....	D16/102	3,395,406	8/1968	Smith .....	2/14
D. 324,394	3/1992	Jannard .....	D16/102	3,675,991	7/1972	Brenn .....	351/41
D. 329,445	9/1992	Jannard .....	D16/116	3,901,589	8/1975	Bienenfeld .....	351/47
D. 330,716	11/1992	Jannard .....	D16/116	3,932,031	1/1976	Johnston .....	351/47
D. 330,903	11/1992	Jannard .....	D16/116	4,217,037	8/1980	Lemelson .....	351/44
D. 335,133	4/1993	Langley .....	D16/102	4,298,991	11/1981	Recenello .....	2/13
D. 335,135	4/1993	Bolle .....	D16/112	4,582,401	4/1986	Grindle .....	351/45
D. 339,596	9/1993	Kopfer .....	D16/102	4,670,914	6/1987	Harris .....	2/436
D. 344,742	3/1994	Jannard .....	D16/112	4,701,962	10/1987	Simon .....	2/15
D. 347,015	5/1994	Saik .....	D16/112	4,726,075	2/1988	Hinrichs .....	2/13
D. 354,972	1/1995	Hirschman .....	D16/314	4,741,611	5/1988	Burns .....	351/44
D. 365,357	12/1995	Jannard et al. ....	D16/335	4,751,746	6/1988	Rustin .....	2/13
D. 365,837	1/1996	Canavan .....	D16/325	4,797,956	1/1989	Boyce .....	2/431
D. 366,056	1/1996	Wolfe .....	D16/314	4,810,080	3/1989	Grendol et al. ....	351/41
D. 371,382	7/1996	Berthet-Bondet .....	D16/326	4,877,320	10/1989	Holden .....	351/44
D. 371,384	7/1996	Bonnemere .....	D16/330	4,955,708	9/1990	Kahaney .....	351/44
D. 374,025	9/1996	Canavan .....	D16/330	4,976,530	12/1990	Mackay et al. ....	351/44
D. 376,613	12/1996	Stepan et al. ....	D16/327	5,000,558	3/1991	Blackstone .....	351/41
D. 377,802	2/1997	Leonardi .....	D16/313	5,146,623	9/1992	Paysan et al. ....	2/12
D. 379,633	6/1997	Garneau .....	D16/315	5,164,749	11/1992	Shelton .....	351/47
D. 380,003	6/1997	Wiedner .....	D16/325	5,218,385	6/1993	Lii .....	351/158
D. 385,897	11/1997	Lin .....	D16/314	5,220,689	6/1993	Miller .....	2/12
D. 387,083	12/1997	Stables .....	D16/321	5,264,875	11/1993	Cooper .....	351/44
D. 388,453	12/1997	Lin .....	D16/315	5,300,963	4/1994	Tanaka .....	351/44
D. 389,167	1/1998	Bolle .....	D16/315	5,319,396	6/1994	Cesarczyk .....	351/62
D. 396,484	7/1998	Stables .....	D16/326	5,321,443	6/1994	Huber et al. ....	351/47
D. 397,132	8/1998	Yee .....	D16/315	5,357,292	10/1994	Wiedner .....	351/105
D. 397,354	8/1998	Kuo .....	D16/330	5,379,464	1/1995	Schleger et al. ....	2/431
D. 397,713	9/1998	Brune et al. ....	D16/326	5,388,269	2/1995	Griffin .....	2/13
D. 398,021	9/1998	Bolle .....	D16/315	5,394,567	3/1995	Vatterott .....	2/449
D. 398,323	9/1998	Bolle .....	D16/315	5,402,189	3/1995	Gill .....	351/44
D. 399,519	10/1998	Yee .....	D16/314	5,422,684	6/1995	Keller .....	351/41
D. 401,607	11/1998	Miniutti .....	D16/314	5,423,092	6/1995	Kawai .....	2/441
D. 402,303	12/1998	Simioni .....	D16/326	5,428,407	6/1995	Sheffield .....	351/58
D. 403,345	12/1998	Flanagan .....	D16/327	5,438,706	8/1995	Lambur .....	2/13
D. 404,054	1/1999	Arnette et al. ....	D16/326	5,463,428	10/1995	Lipton et al. ....	351/158
D. 404,416	1/1999	Wiedner .....	D16/315	5,469,229	11/1995	Greenbaum .....	351/44
D. 407,566	4/1999	Lane .....	D16/326	5,483,303	1/1996	Hirschman .....	351/118
D. 408,840	4/1999	Lane .....	D16/321	5,488,438	1/1996	Cochran .....	351/45
D. 410,022	5/1999	Conway .....	D16/327	5,502,515	3/1996	Sansalone .....	351/43
D. 416,933	11/1999	Lane .....	D16/326	5,530,490	6/1996	Canavan .....	351/41
D. 417,461	12/1999	Lane .....	D16/326	5,543,864	8/1996	Hirschman et al. ....	351/47
D. 418,534	1/2000	Lane .....	D16/326	5,548,351	8/1996	Hirschman et al. ....	351/47
D. 419,585	1/2000	Lane .....	D16/325	5,561,480	10/1996	Capes .....	351/45
D. 433,697	11/2000	Lane .....	D16/315	5,598,230	1/1997	Quaresima .....	351/44
D. 433,698	11/2000	Lane .....	D16/328	5,608,469	3/1997	Bollé .....	351/44
D. 434,062	11/2000	Lane .....	D16/326	5,614,963	3/1997	Parker .....	351/47
D. 434,063	11/2000	Lane .....	D16/326	5,619,750	4/1997	Allewalt .....	2/13
D. 434,064	11/2000	Lane .....	D16/330	5,654,786	8/1997	Bylander .....	351/49

\* cited by examiner

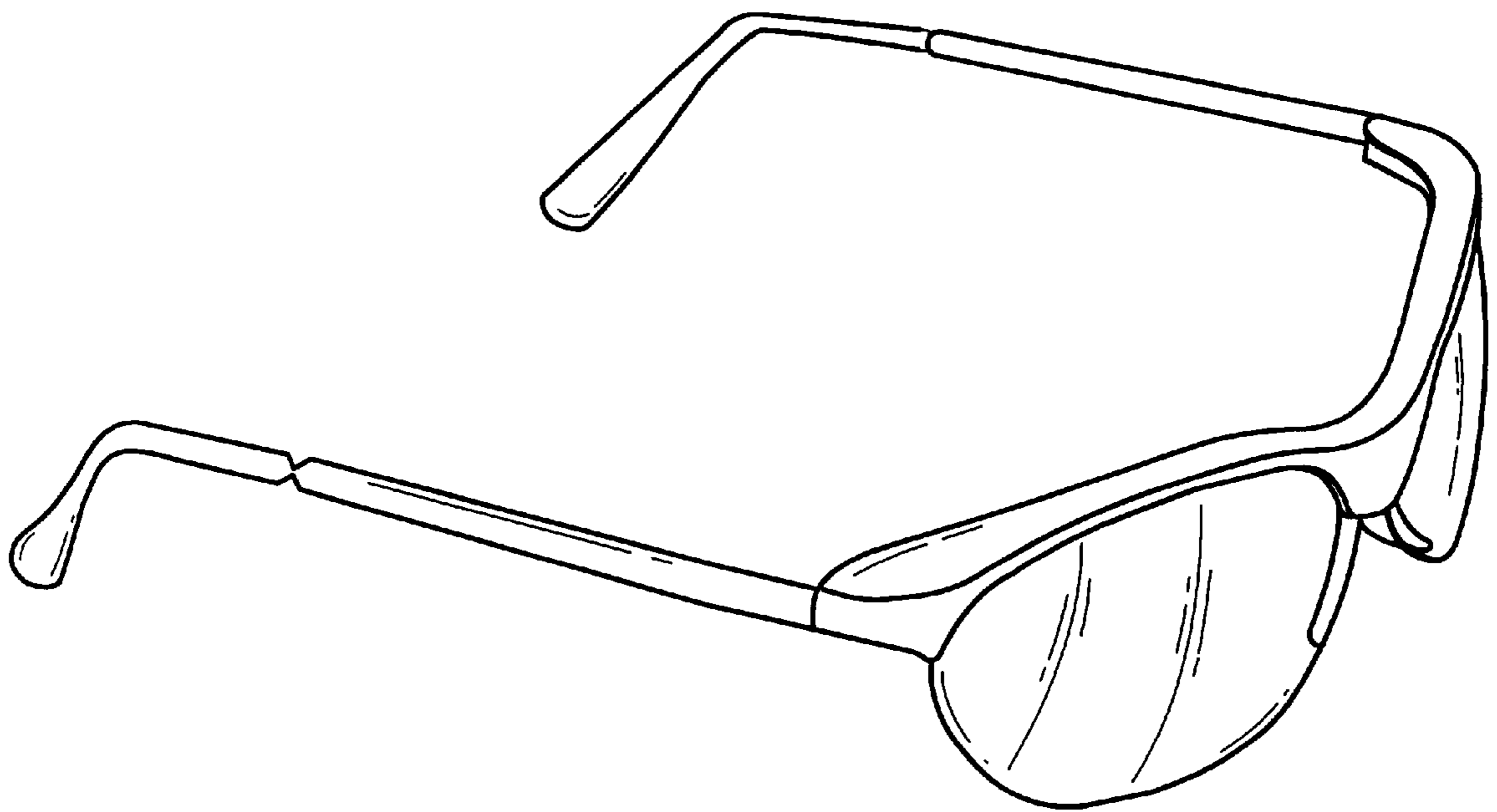

*Fig. 1*

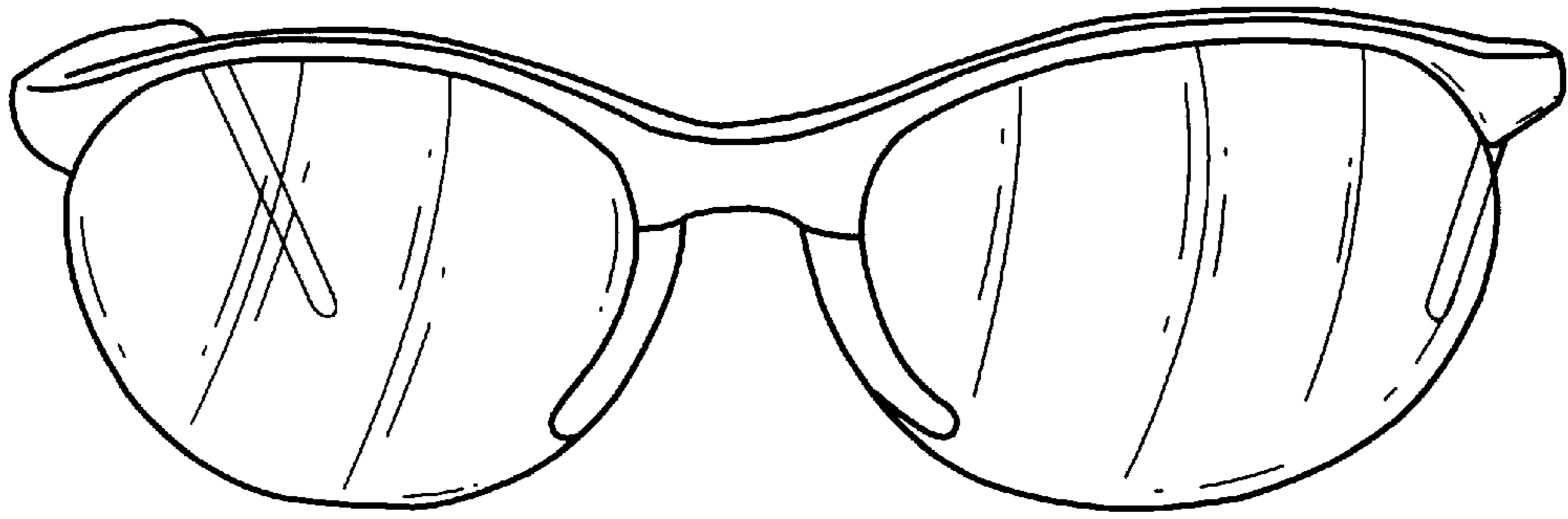

*Fig. 2*

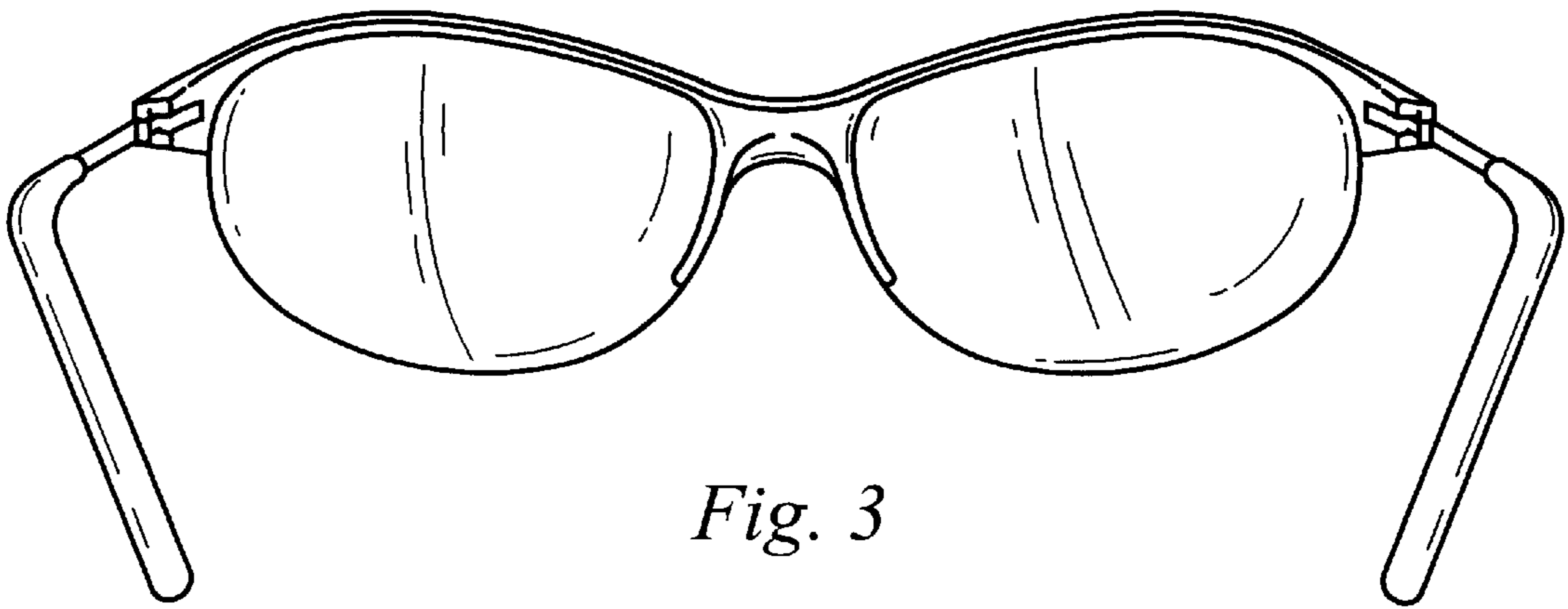

*Fig. 3*

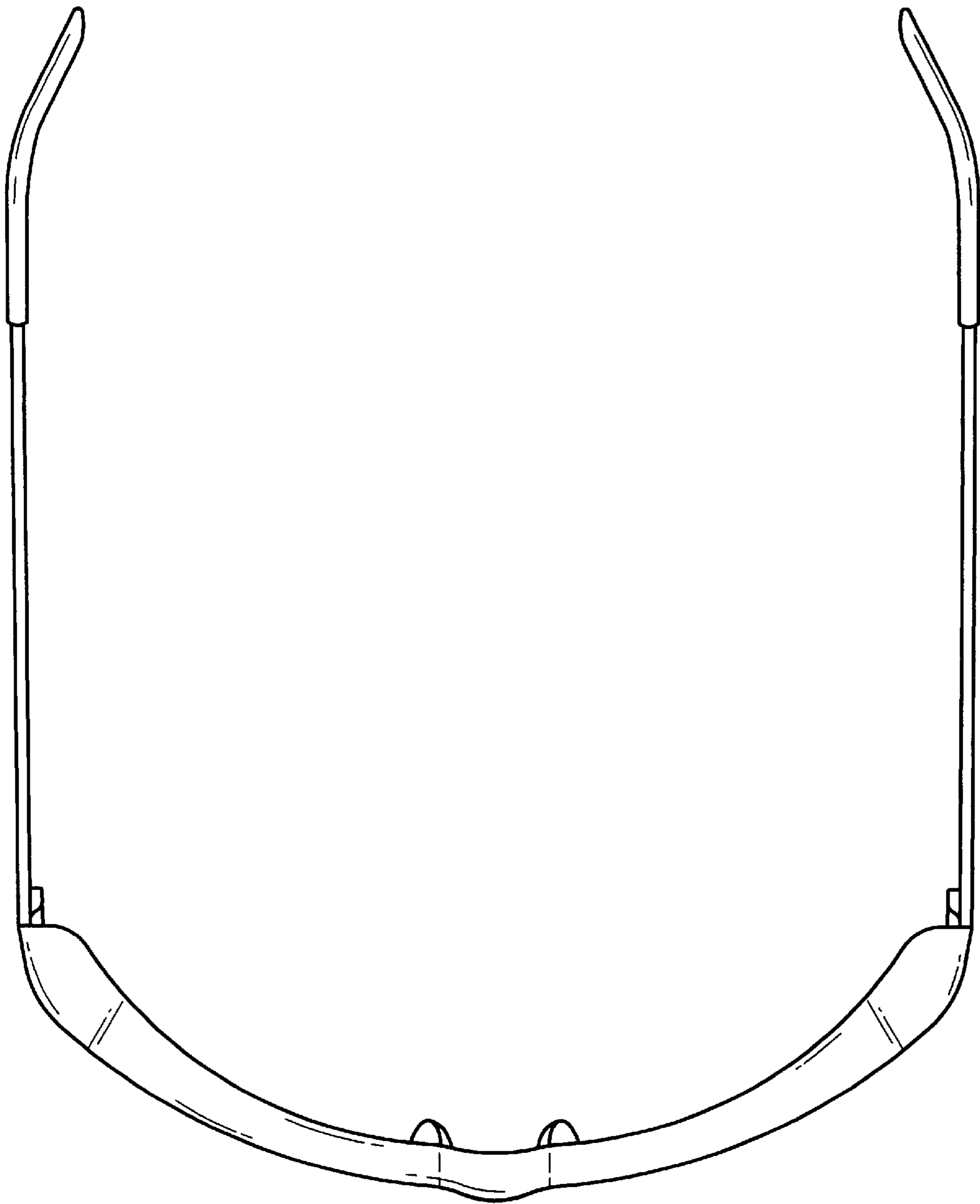

*Fig. 4*

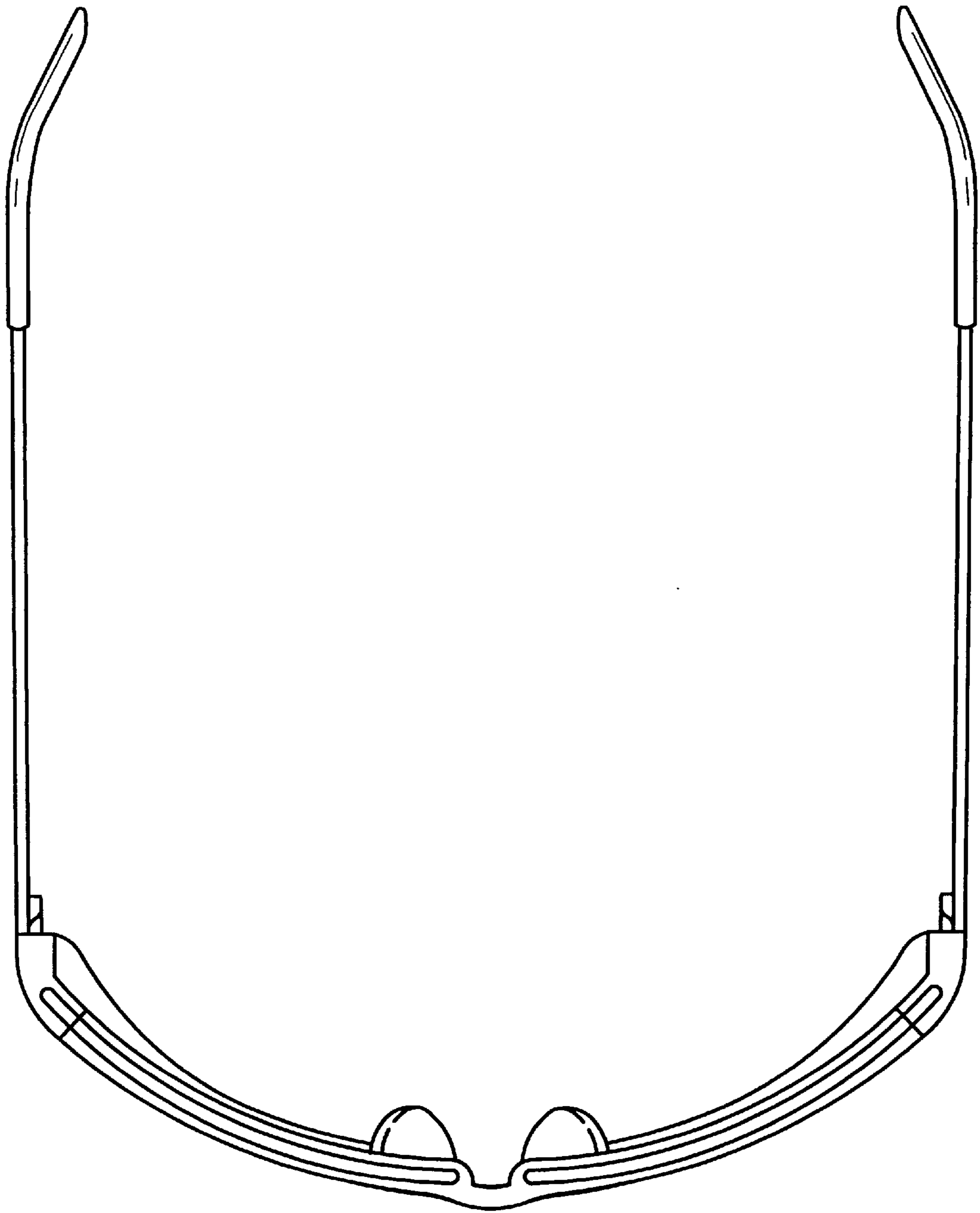

*Fig. 5*

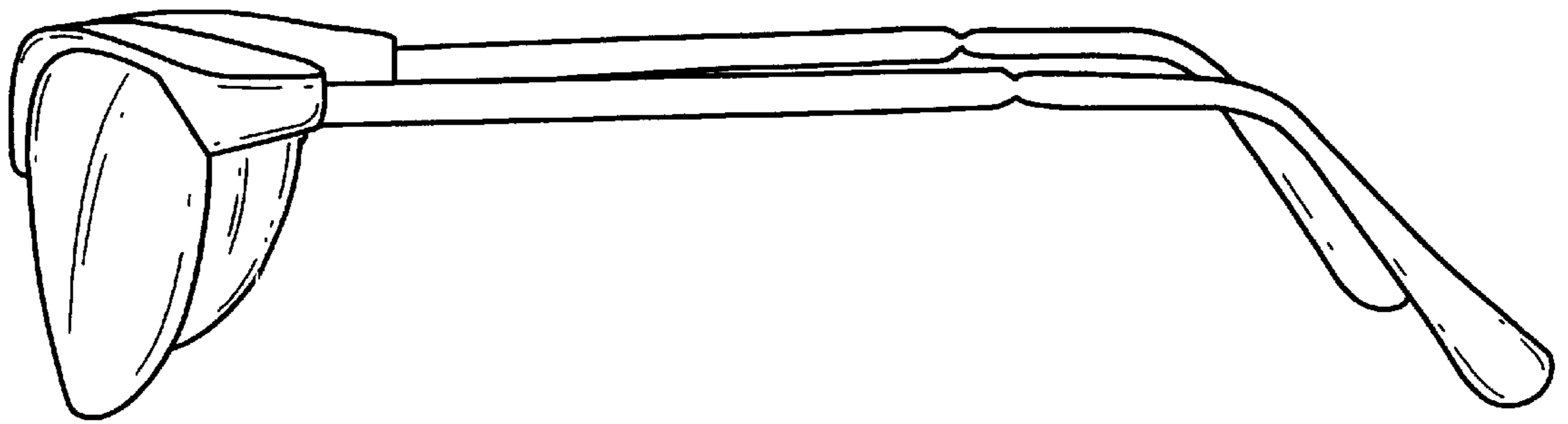

*Fig. 6*