



US00D447752B1

(12) **United States Design Patent**
Matthew et al.

(10) **Patent No.:** **US D447,752 S**

(45) **Date of Patent:** **** Sep. 11, 2001**

(54) **COMPRESSOR**

(75) Inventors: **Mark R. Matthew**, New Ulm, MN (US); **David McCoy**, Oswego, IL (US); **Tom Graber**, New Ulm, MN (US); **Richard Hawkes**, Naperville, IL (US); **Keith Kristiansen**, Statford, CT (US); **John Kiely**, Morris Plains, NJ (US); **Gary Grossman**, Riverside, CT (US); **Thomas C. Vandyk**, Ramsey, NJ (US)

(73) Assignee: **Coleman Powermate, Inc.**, Kearney, NE (US)

(**) Term: **14 Years**

(21) Appl. No.: **29/126,298**

(22) Filed: **Jul. 12, 2000**

(51) **LOC (7) Cl.** **15-02**

(52) **U.S. Cl.** **D15/9**

(58) **Field of Search** D15/7-9; 417/360, 417/362, 44.9, 231, 233, 234; 137/899.4, 565; 248/645, 675

D. 352,292	11/1994	Morgan .	
D. 352,293	11/1994	Morgan .	
D. 352,295 *	11/1994	Morgan	D15/9
D. 403,330 *	12/1998	Williams	D15/9
D. 403,331 *	12/1998	Williams	D15/9
D. 407,413 *	3/1999	Wang	D15/9
D. 409,206 *	5/1999	Wang	D15/9
D. 422,603 *	4/2000	DeYoung	D15/9
1,730,319	10/1929	Dilks .	
1,846,655	2/1932	Rayfield .	
2,136,098	11/1938	Browne .	
2,384,174	9/1945	Jones .	
2,804,259	8/1957	Ralston .	
4,077,747	3/1978	Burenga .	
4,722,673	2/1988	Grime et al. .	

* cited by examiner

Primary Examiner—Ralf Siefert

(74) *Attorney, Agent, or Firm*—Kramer Levin Naftalis & Frankel, LLP.

(57) **CLAIM**

The ornamental design for a compressor, as shown and described.

DESCRIPTION

FIG. 1 is a front elevation view showing the new design; FIG. 2 is a rear elevation view thereof; FIG. 3 is a side elevation view thereof; FIG. 4 is a side elevation view thereof, showing the opposite side of FIG. 3; FIG. 5 is a top plan view thereof; and, FIG. 6 is a bottom plan view thereof. The broken lines shown in the drawings identify environmental structure or boundaries that form no part of the design to be patented.

1 Claim, 6 Drawing Sheets

(56) **References Cited**

U.S. PATENT DOCUMENTS

D. 144,482	4/1946	Davis et al. .
D. 156,075	11/1949	Collier .
D. 185,000	4/1959	Hoover .
D. 223,039	2/1972	Widmer .
D. 243,282	2/1977	Burenga .
D. 273,011	3/1984	Dudley .
D. 273,493	4/1984	Vitaloni .
D. 293,446	12/1987	Morgan .
D. 293,584	1/1988	Morgan .
D. 293,585	1/1988	Morgan .
D. 332,613	1/1993	Keller .

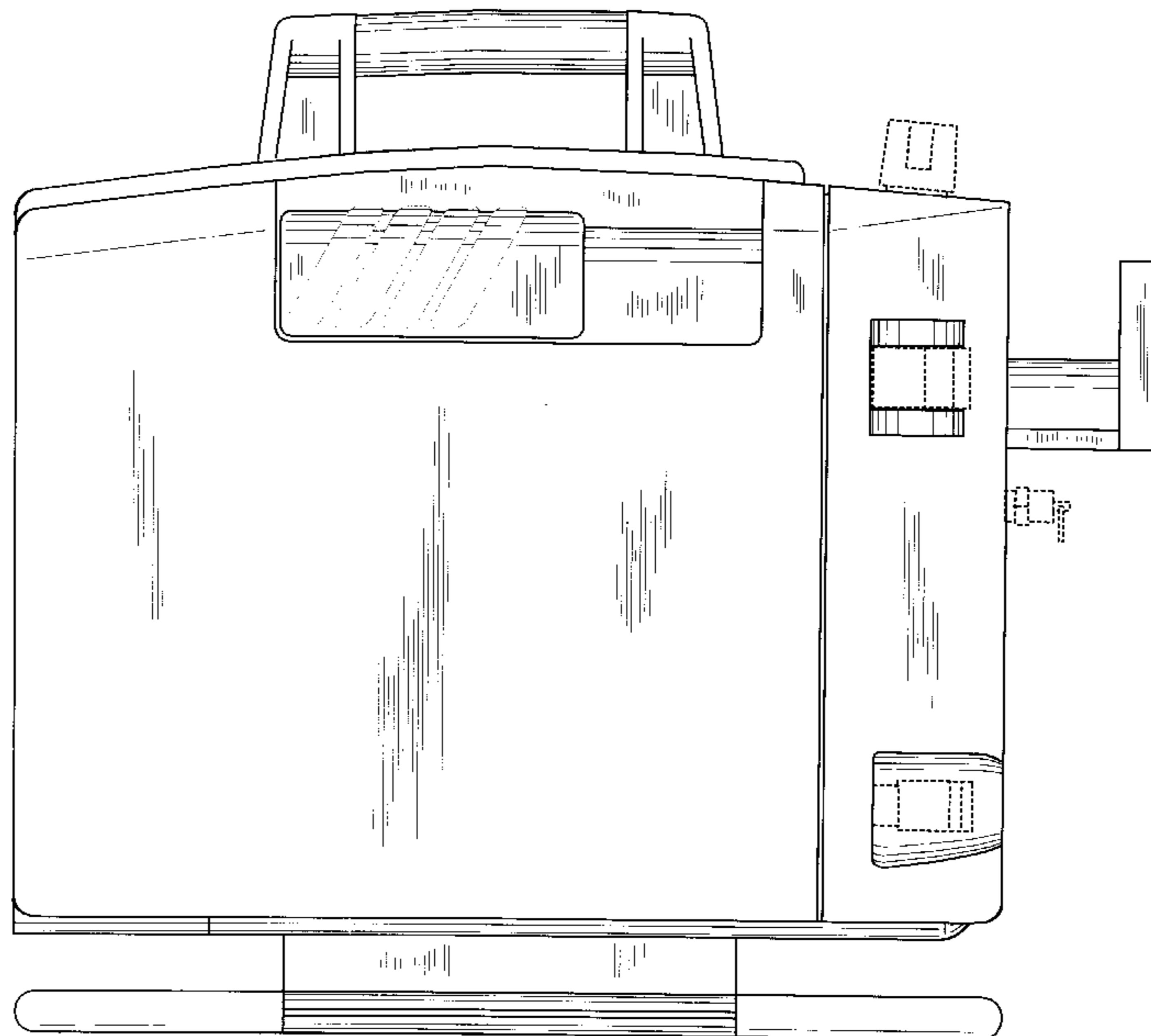

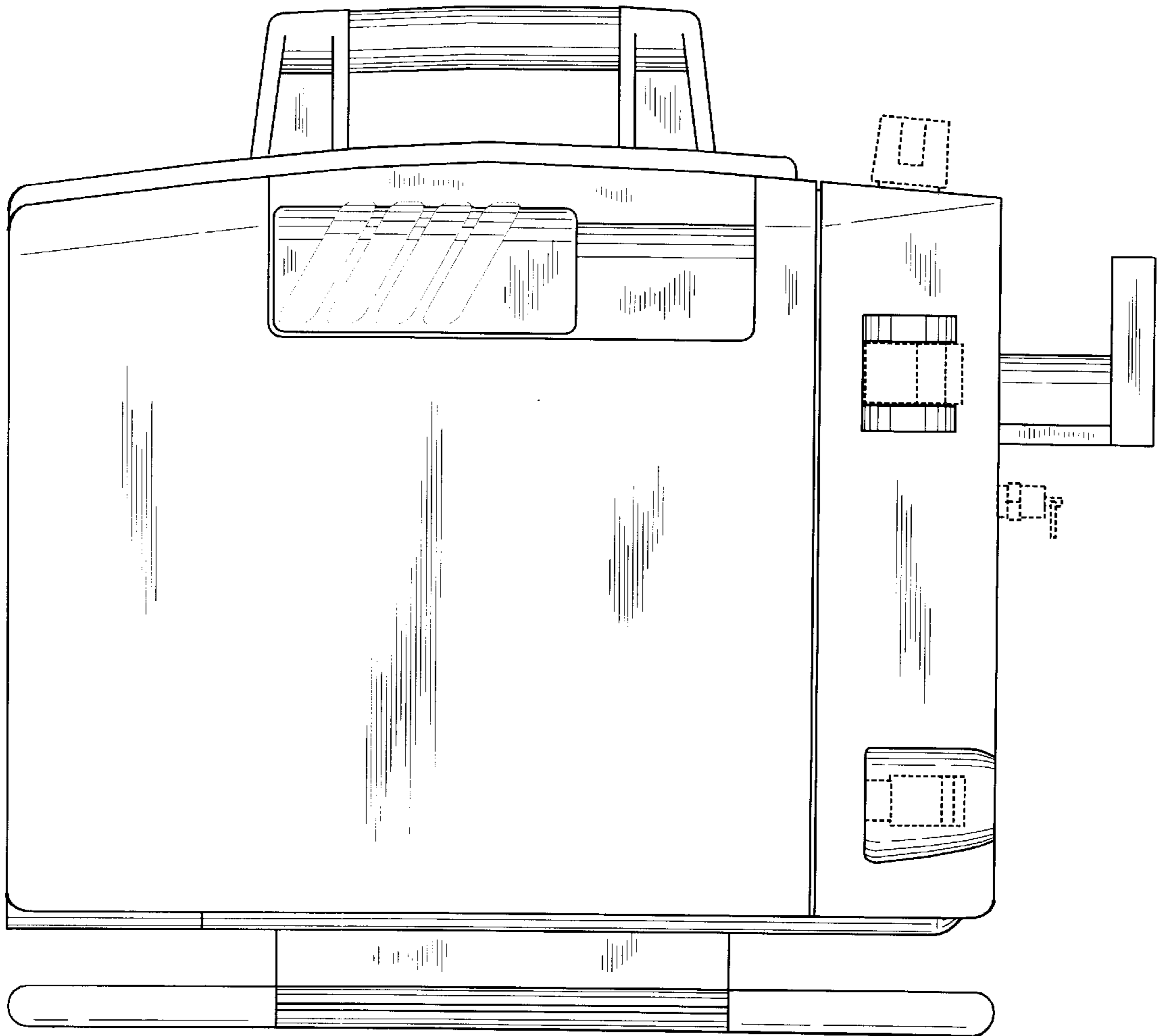

FIG. 1

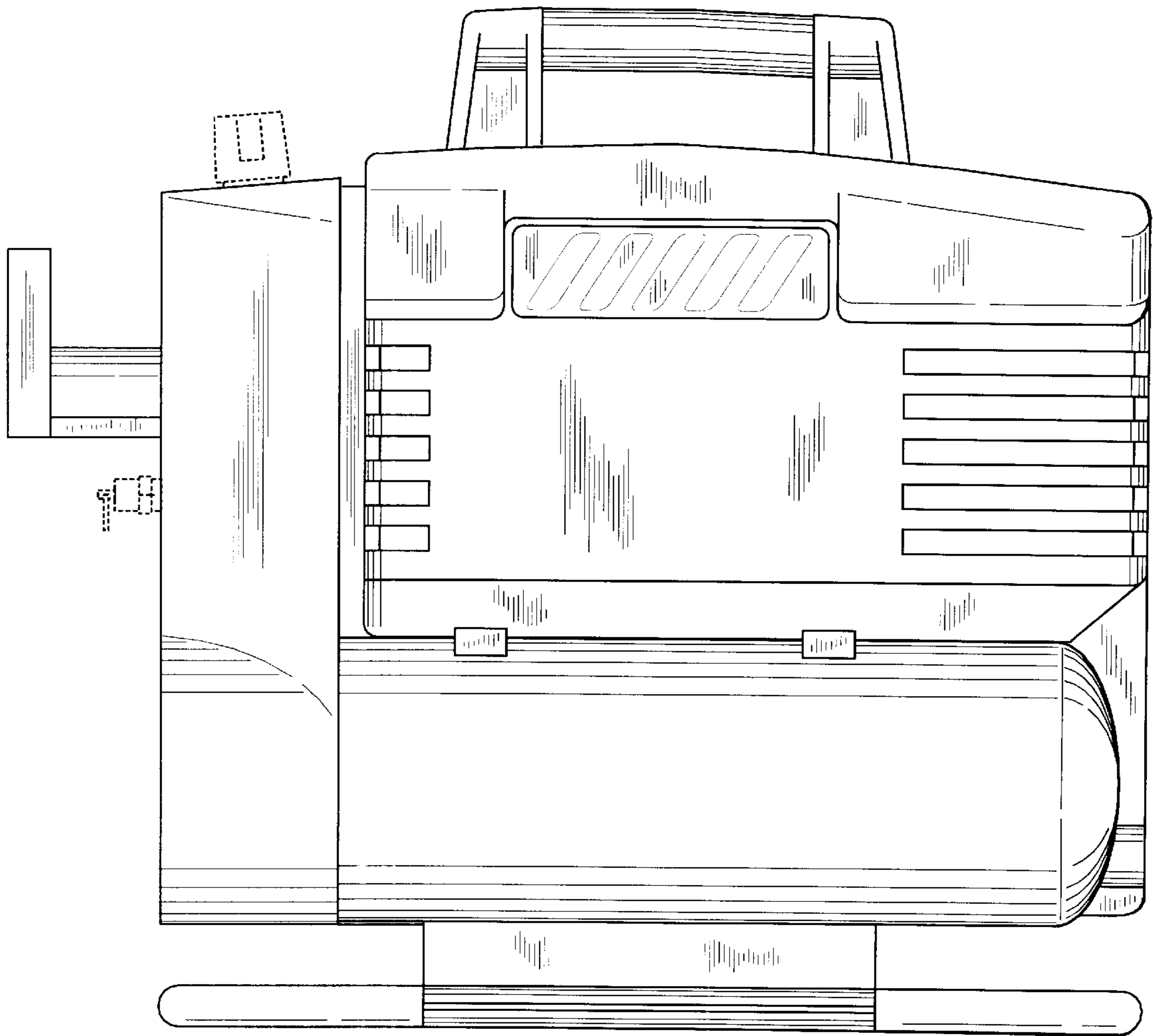

FIG. 2

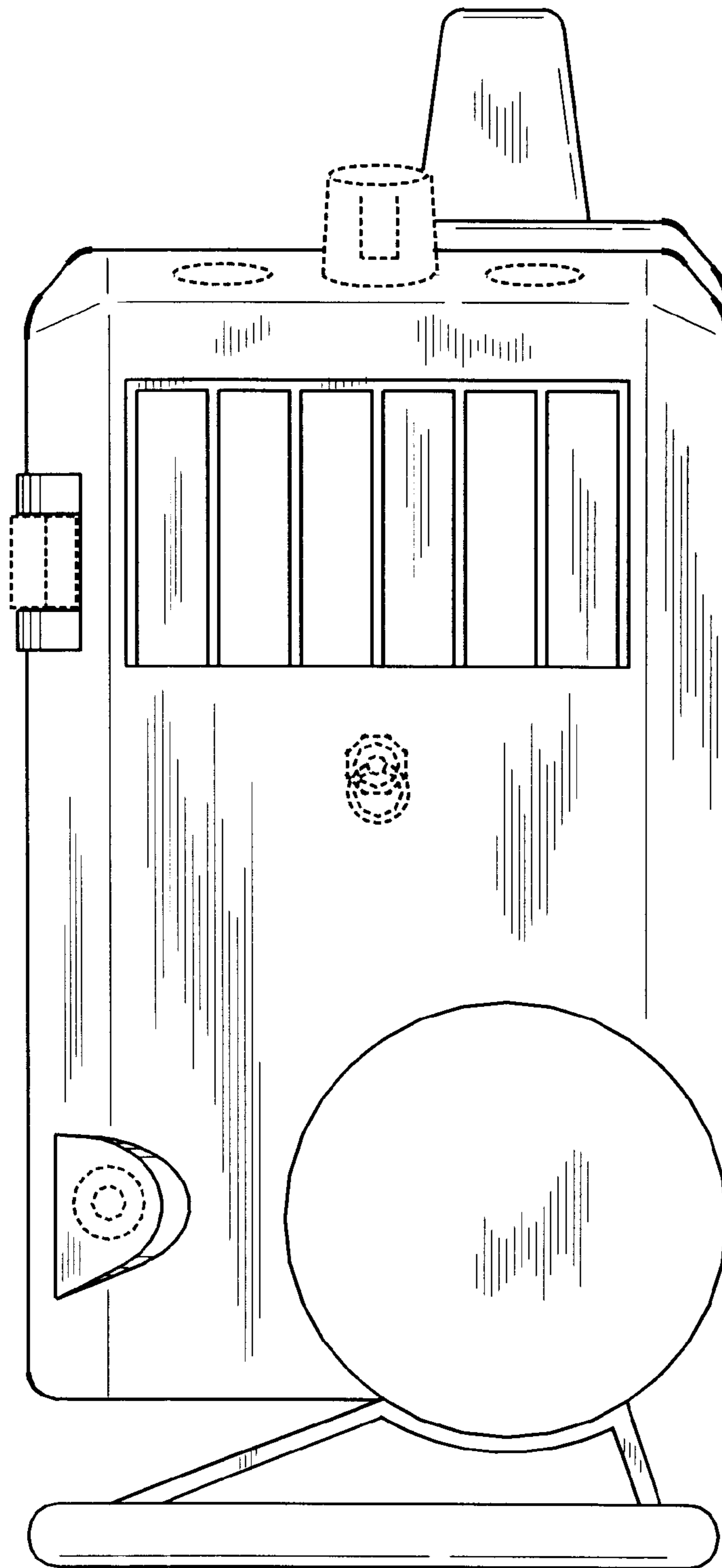

FIG. 3

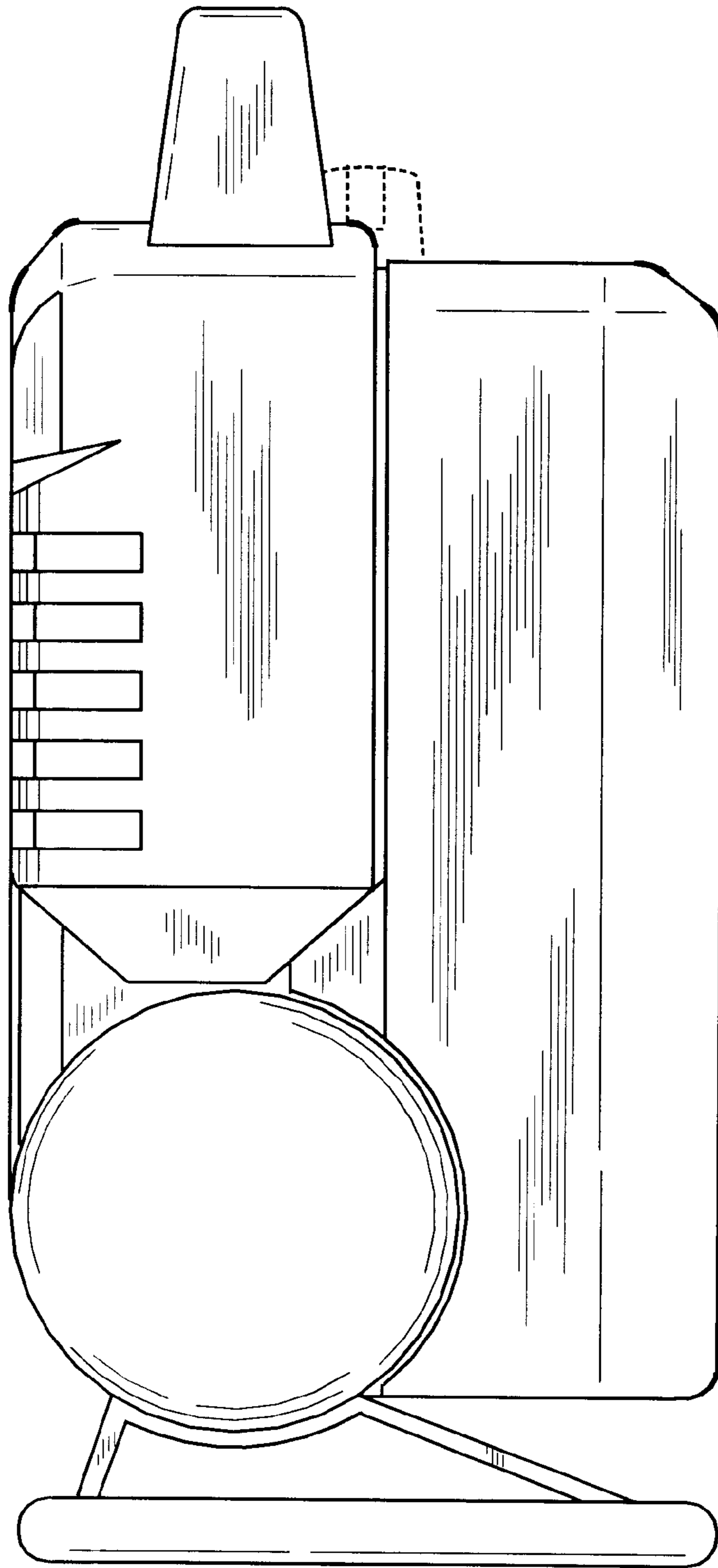

FIG. 4

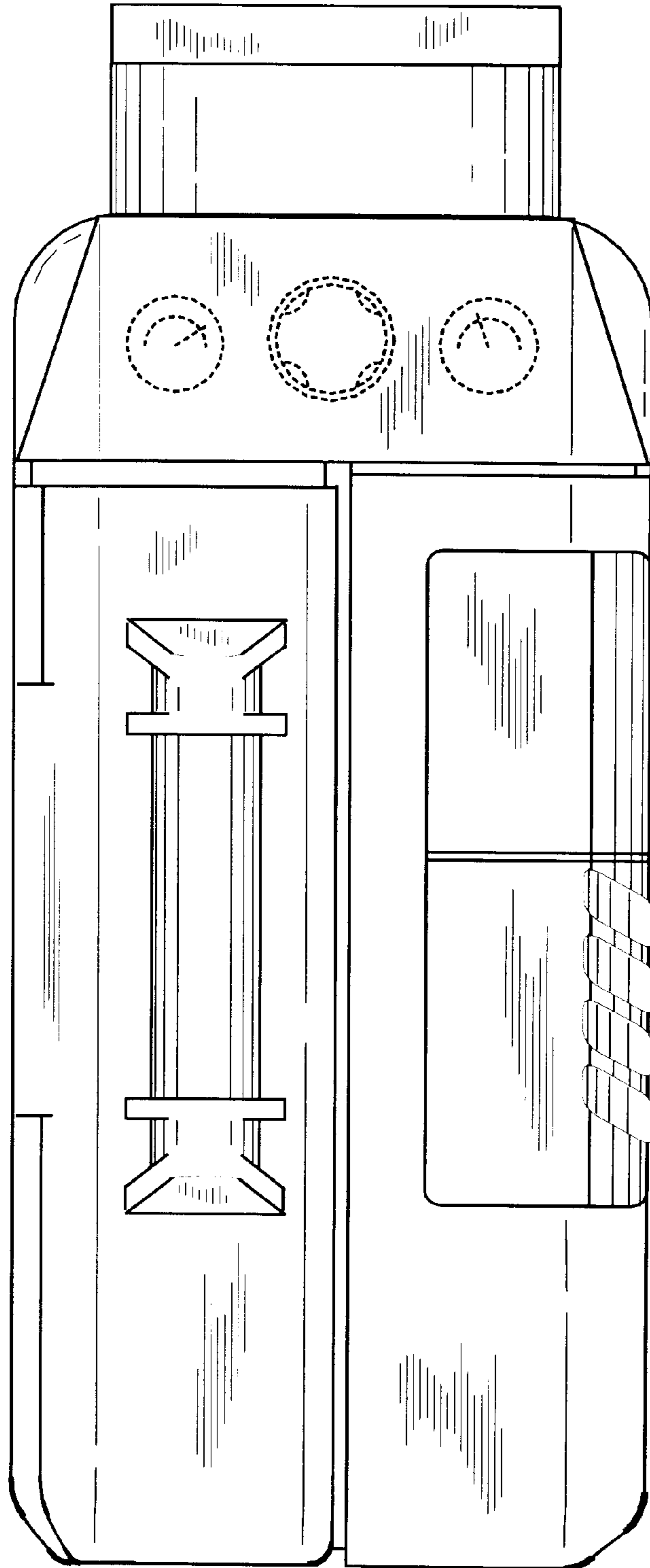

FIG. 5

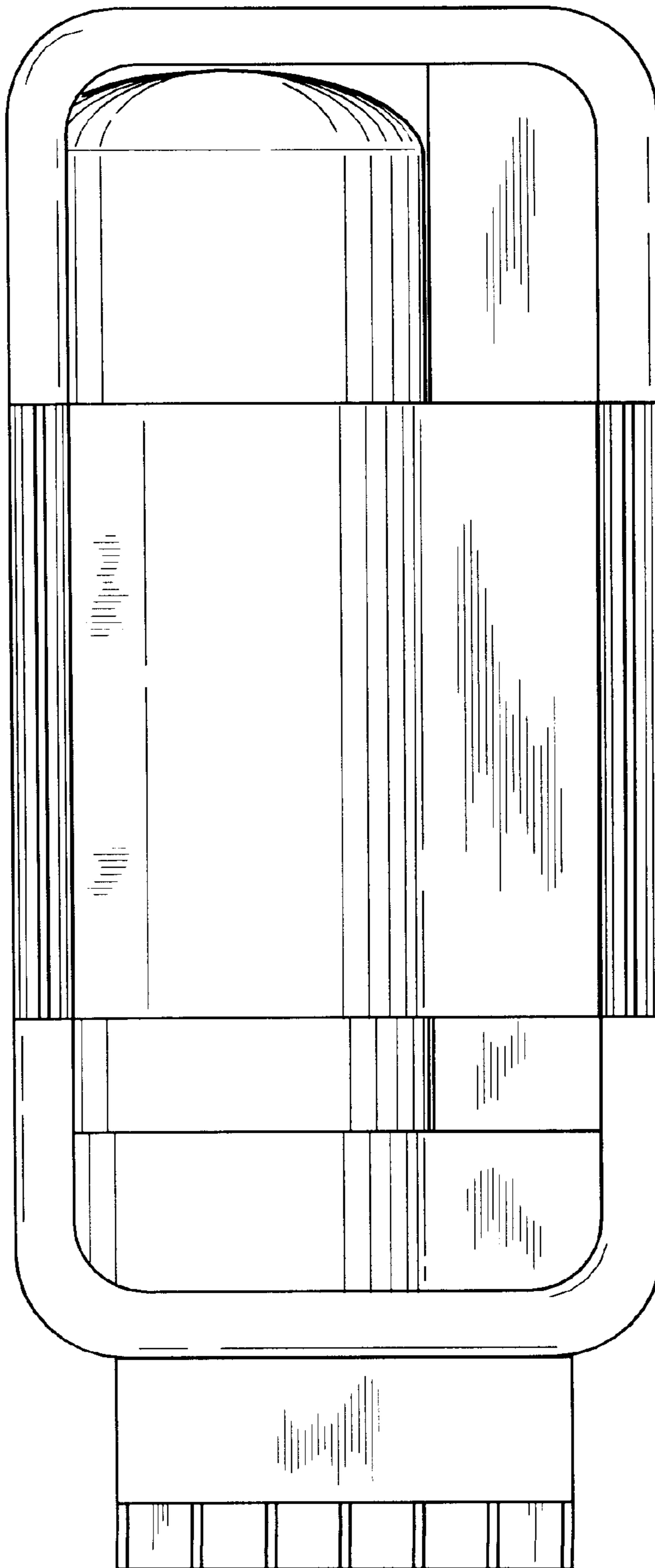

FIG. 6