



US00D447747B1

(12) **United States Design Patent**
Ogden et al.

(10) **Patent No.:** **US D447,747 S**

(45) **Date of Patent:** **** Sep. 11, 2001**

(54) **STORAGE DEVICE ENCLOSURE**

5,822,296 * 10/1998 Nakamichi 369/192

(75) Inventors: **Dennis Duane Ogden**, Longmont; **Lee Schultz**, Arvada, both of CO (US);
Richard Watson, Norwell; **Alexander Muller**, Cambridge, both of MA (US)

* cited by examiner

Primary Examiner—Freda Nunn

(74) *Attorney, Agent, or Firm*—Parsons, Behle & Latimer

(73) Assignee: **Iomega Corporation**, Roy, UT (US)

(57) **CLAIM**

(**) Term: **14 Years**

The ornamental design for a storage device enclosure, as shown and described.

(21) Appl. No.: **29/125,404**

DESCRIPTION

(22) Filed: **Jun. 23, 2000**

FIG. 1 is a top perspective view of the front of a storage device enclosure showing a preferred embodiment of our design, which preferred embodiment is also shown in FIGS. 2—10;

(51) **LOC (7) Cl.** **14-02**

(52) **U.S. Cl.** **D14/370; D14/353; D14/156**

(58) **Field of Search** D14/356, 348,
D14/361–363, 368, 353, 355, 426, 156;
D13/162, 184, 199; D6/432, 436, 445,
448; 312/99.12; 369/34, 36, 75.1, 75.2,
77.1, 77.2, 192; 361/680–686

FIG. 2 is a top perspective view of the rear;

FIG. 3 is a top view;

FIG. 4 is a bottom view;

FIG. 5 is a front view;

FIG. 6 is a rear view;

FIG. 7 is a side view;

FIG. 8 is another side view;

FIG. 9 is a perspective view showing an exemplary manner of using the storage device enclosure; and,

FIG. 10 is another perspective view showing another manner of using the storage device enclosure.

(56) **References Cited**

U.S. PATENT DOCUMENTS

- D. 338,463 * 8/1993 Hisatsune D14/156
- D. 350,735 * 9/1994 Karlin et al. D14/426
- D. 380,199 * 6/1997 Beruscha et al. D13/184
- D. 410,463 * 6/1999 Hattori D14/156

1 Claim, 4 Drawing Sheets

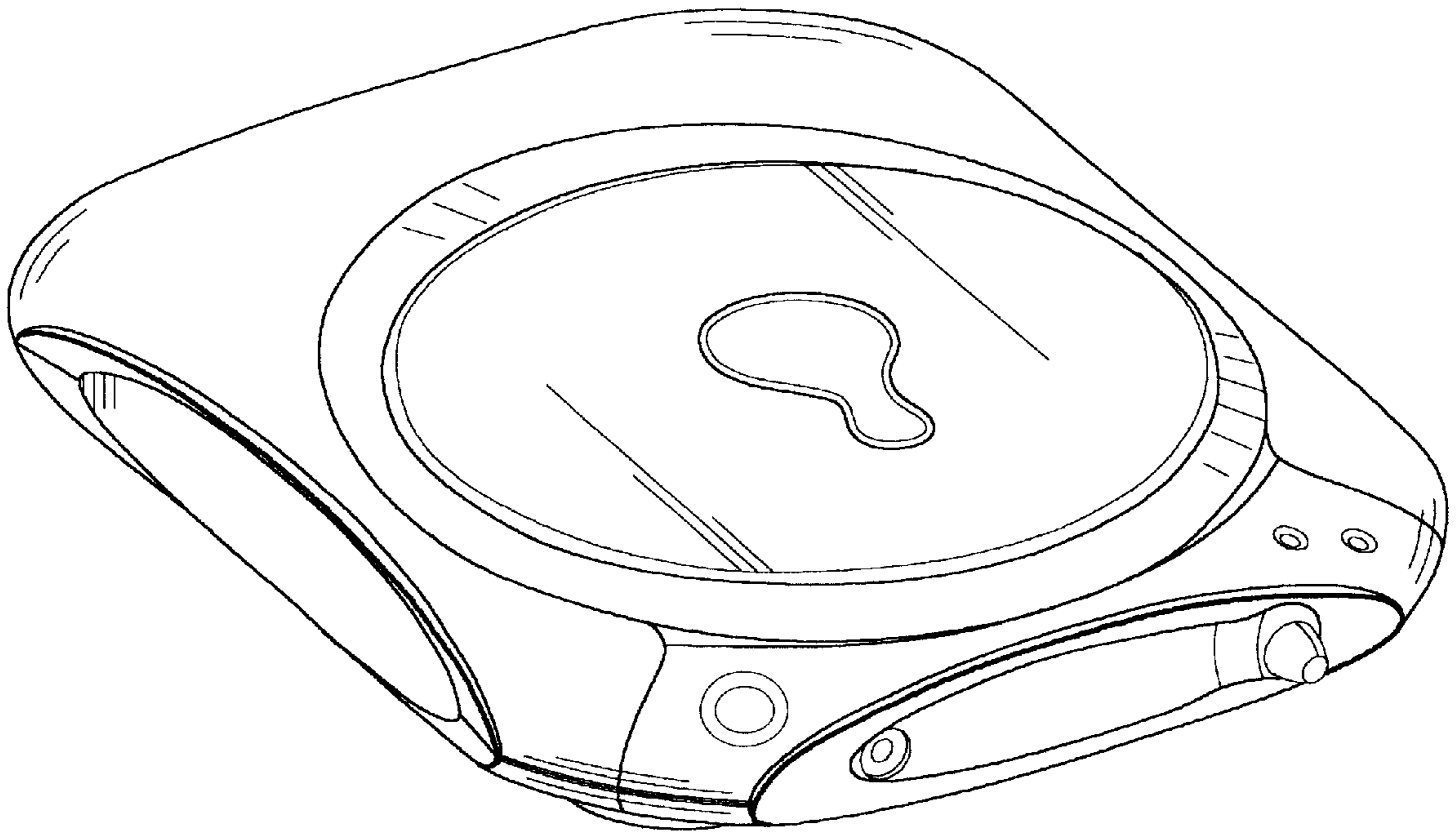

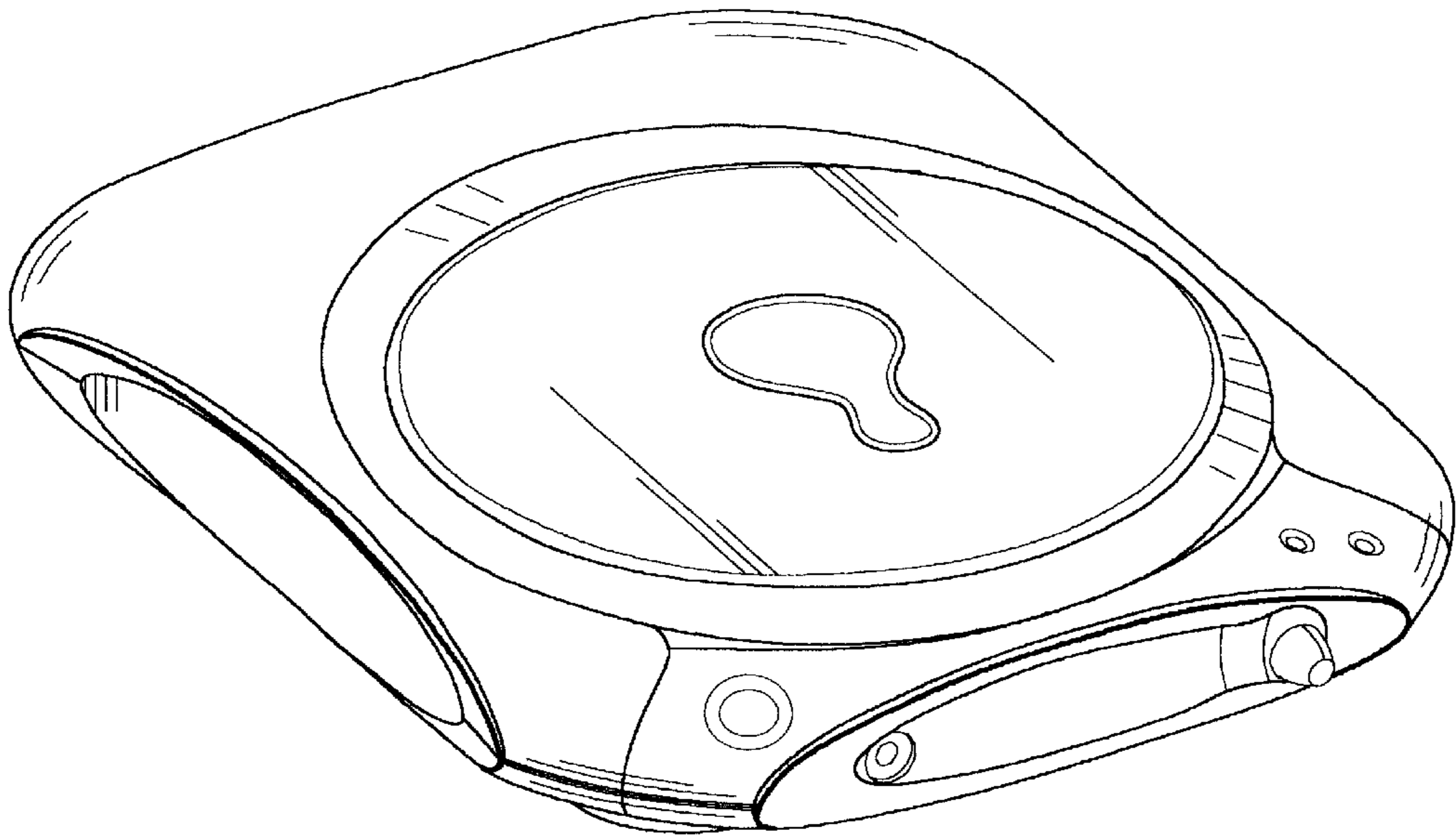

FIG. 1

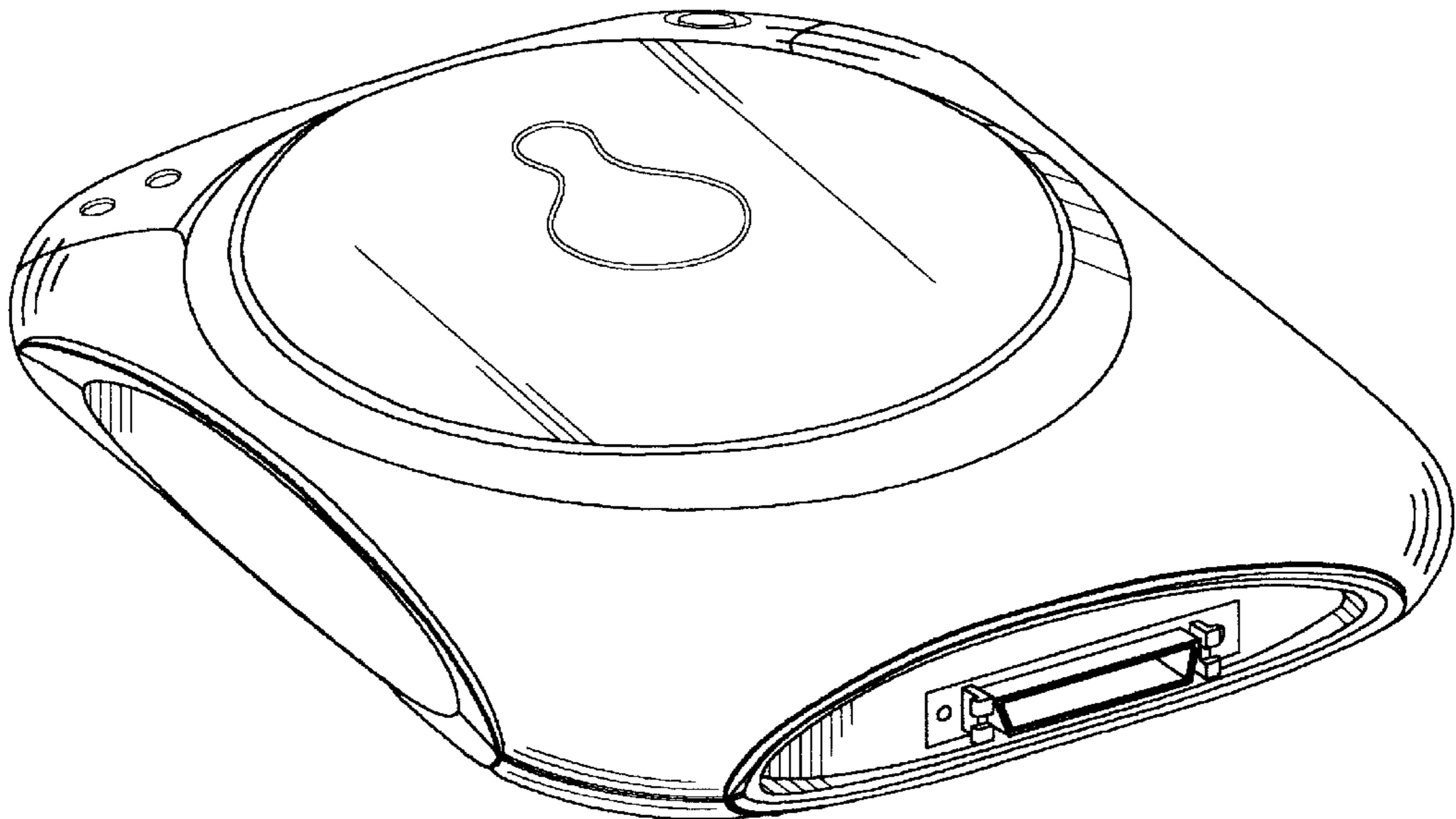

FIG. 2

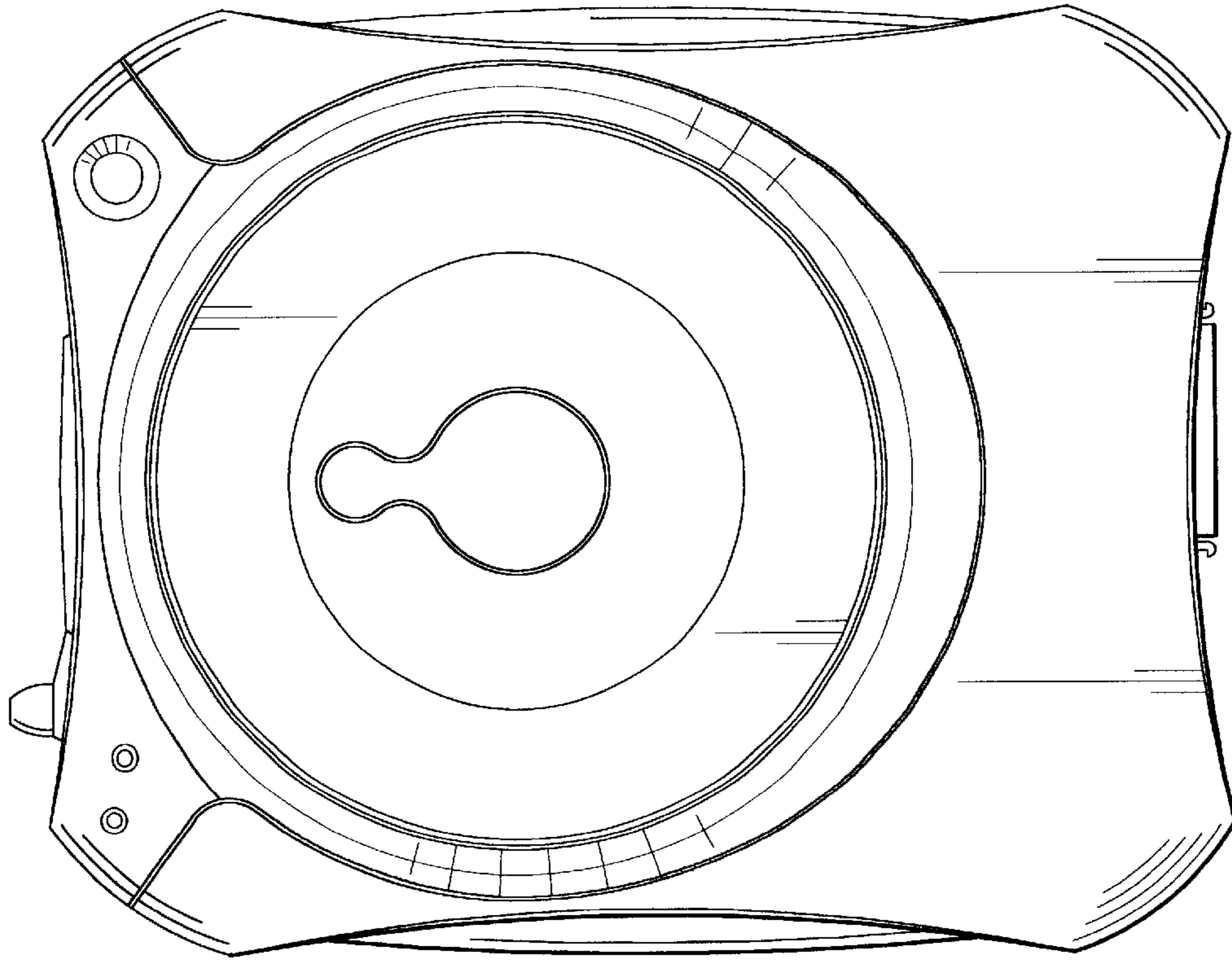

FIG. 3

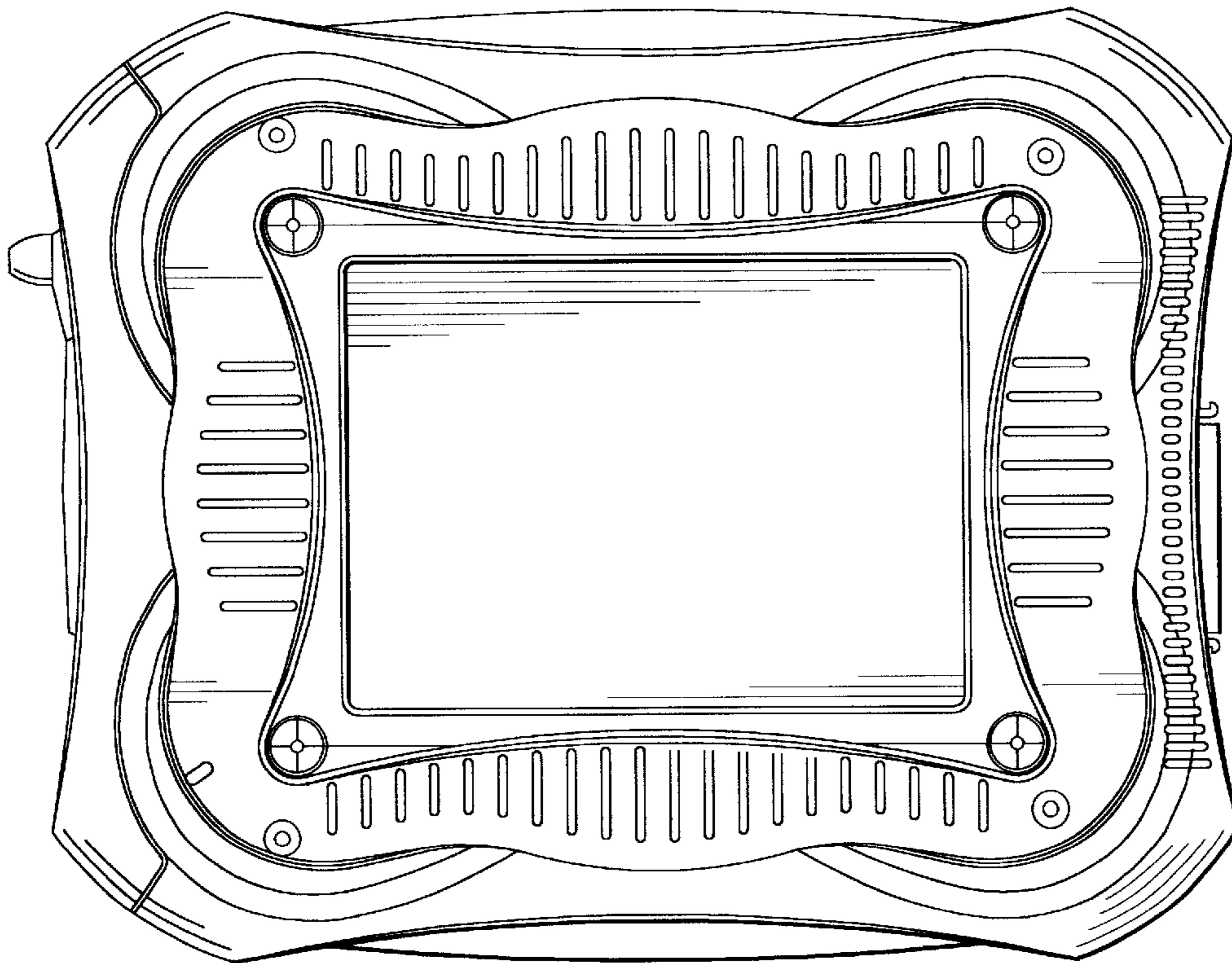

FIG. 4

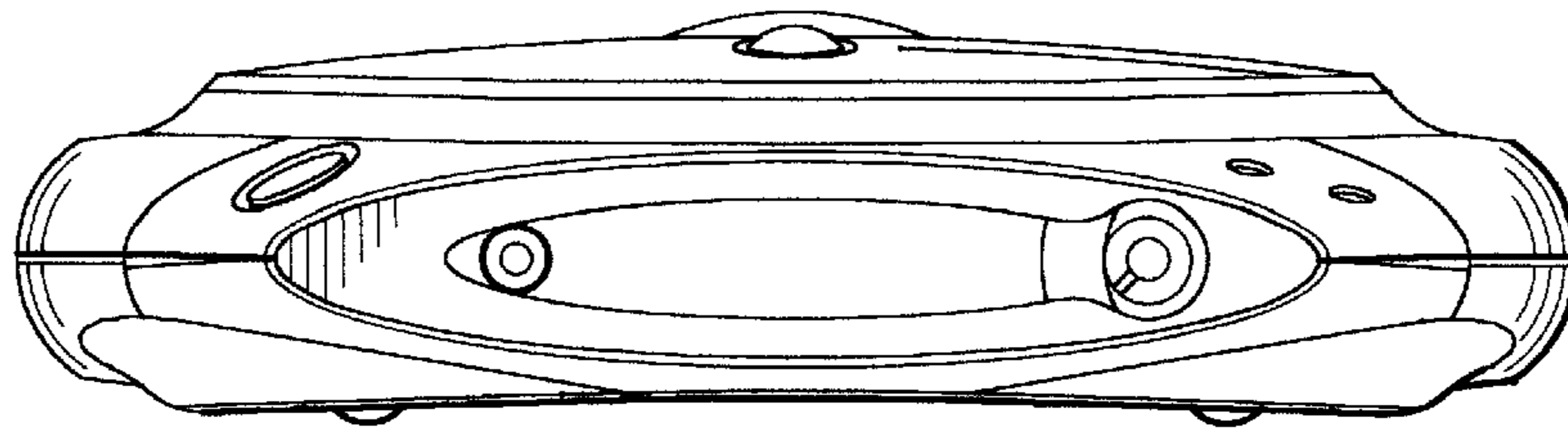

FIG. 5

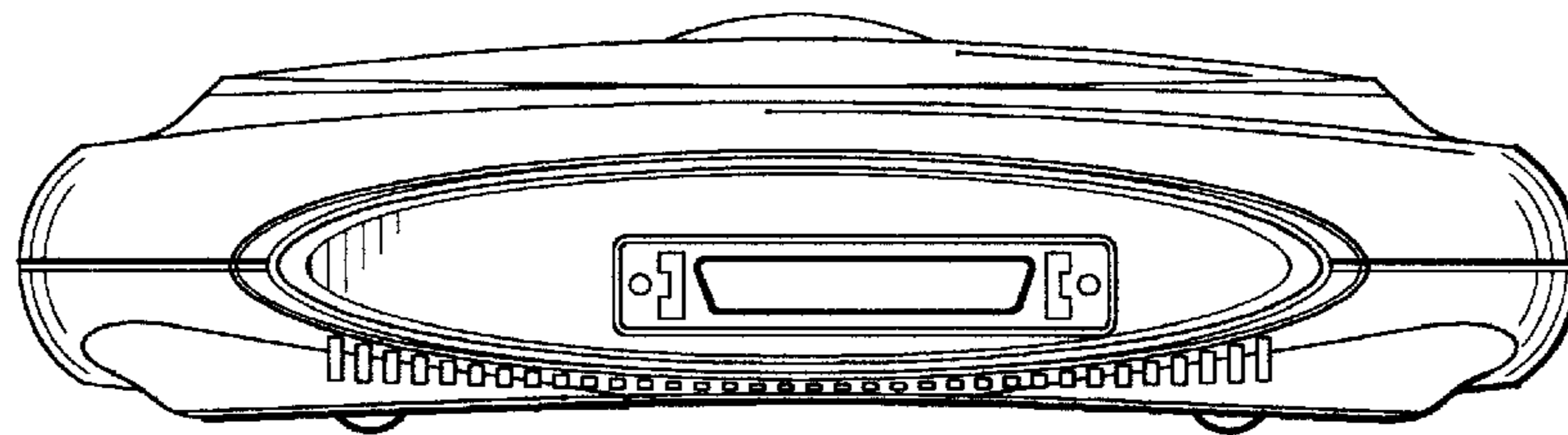

FIG. 6

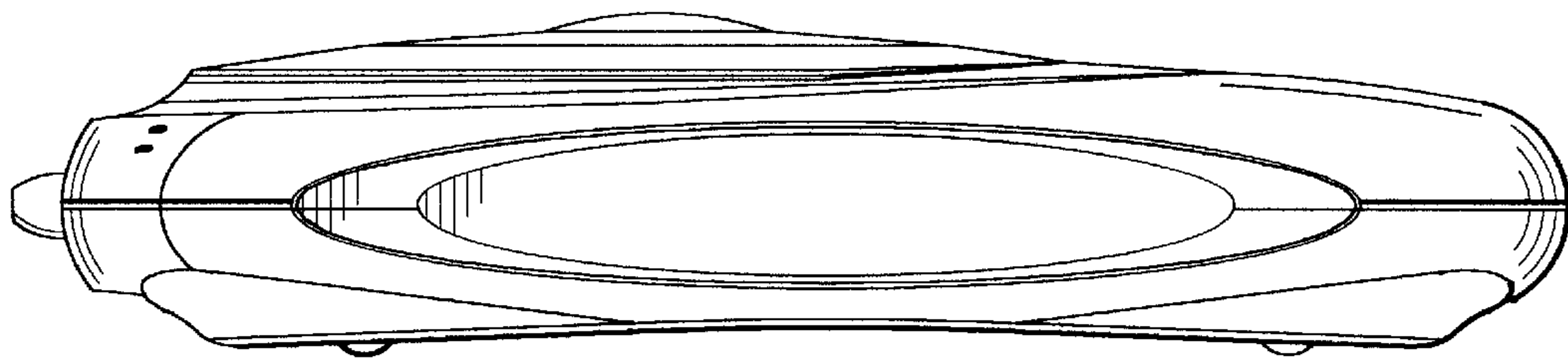

FIG. 7

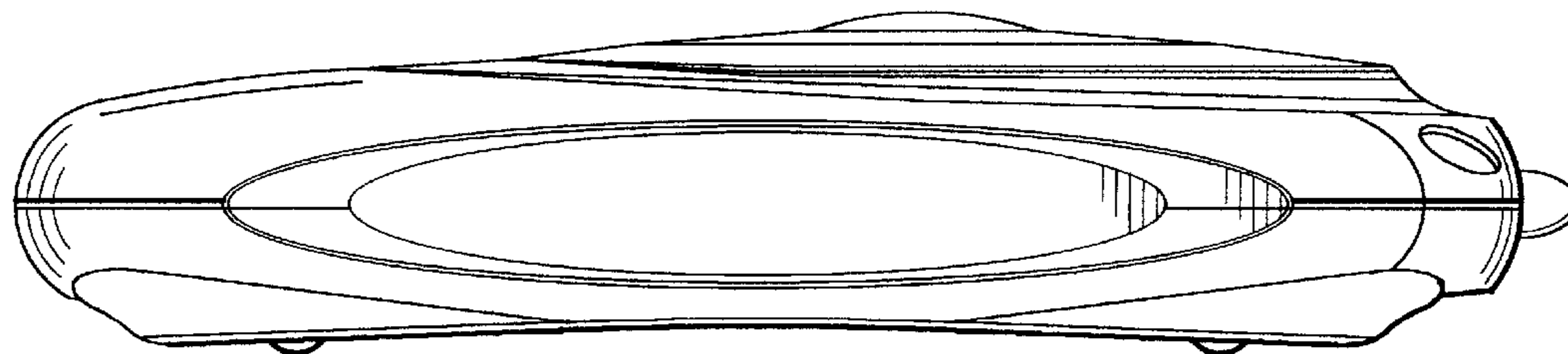

FIG. 8

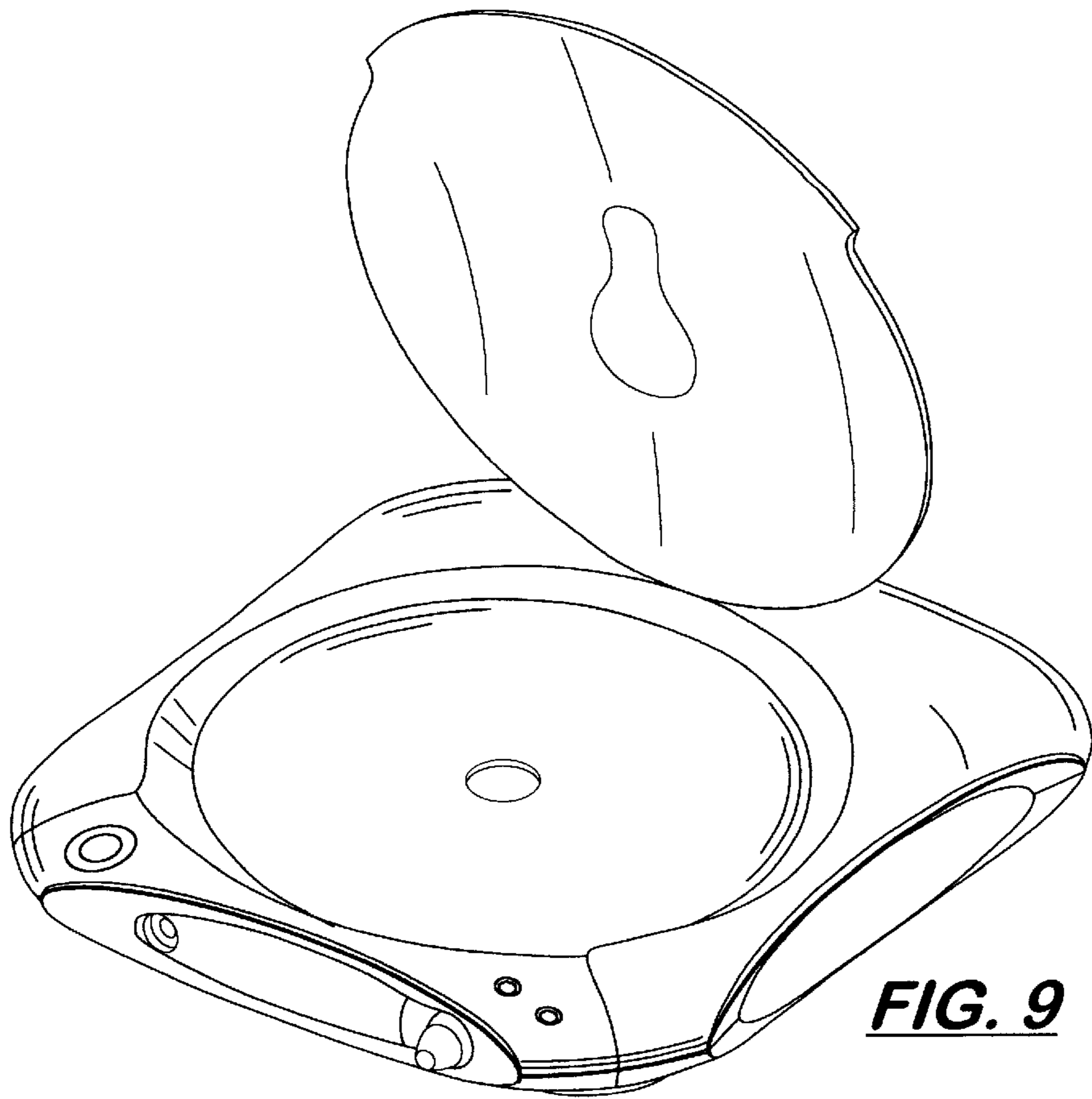

FIG. 9

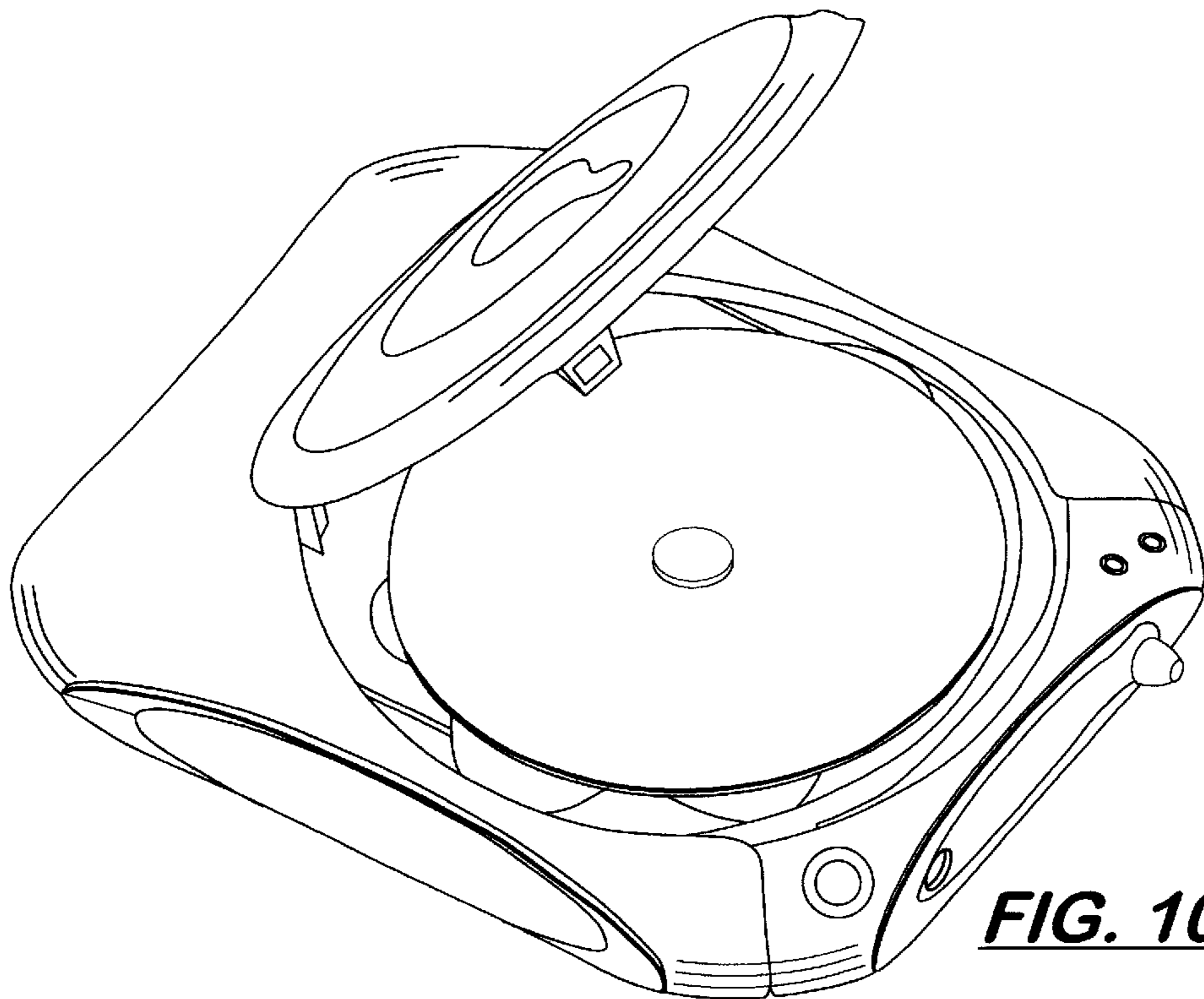

FIG. 10