



US00D447469B1

(12) **United States Design Patent**  
**Ito et al.**

(10) **Patent No.:** **US D447,469 S**  
(45) **Date of Patent:** **\*\* Sep. 4, 2001**

(54) **DIGITAL AUDIO DISC PLAYER**

(75) Inventors: **Masafumi Ito; Minoru Sube;**  
**Hiroyuki Watanabe; Yukio Iikura,** all  
of Musashino (JP)

(73) Assignee: **TEAC Corporation,** Tokyo (JP)

(\*\*) Term: **14 Years**

(21) Appl. No.: **29/125,422**

(22) Filed: **Jun. 23, 2000**

(30) **Foreign Application Priority Data**

Dec. 28, 1999 (JP) ..... 11-37234

(51) **LOC (7) Cl.** ..... **14-01**

(52) **U.S. Cl.** ..... **D14/156**

(58) **Field of Search** ..... D14/125, 135,  
D14/136, 156, 157, 168, 239, 496; 369/75.1,  
75.2, 77.1, 77.2

(56) **References Cited**

**U.S. PATENT DOCUMENTS**

D. 415,758 \* 10/1999 Ito et al. .... D14/156

D. 428,404 \* 7/2000 Ito et al. .... D14/156  
D. 431,238 \* 9/2000 Ito et al. .... D14/156  
5,852,594 \* 12/1998 Kaise et al. .... 369/75.1

**FOREIGN PATENT DOCUMENTS**

1056241 12/1999 (JP) .

\* cited by examiner

*Primary Examiner*—Nanda Bondade

(74) *Attorney, Agent, or Firm*—Ladas & Parry

(57) **CLAIM**

The ornamental design for a digital audio disc player, as shown and described.

**DESCRIPTION**

FIG. 1 is a perspective view of a digital audio disc player showing our new design;  
FIG. 2 is a front view thereof;  
FIG. 3 is a rear view thereof;  
FIG. 4 is a right side view thereof;  
FIG. 5 is a left side view thereof;  
FIG. 6 is a top view thereof; and,  
FIG. 7 is a bottom view thereof.

**1 Claim, 4 Drawing Sheets**

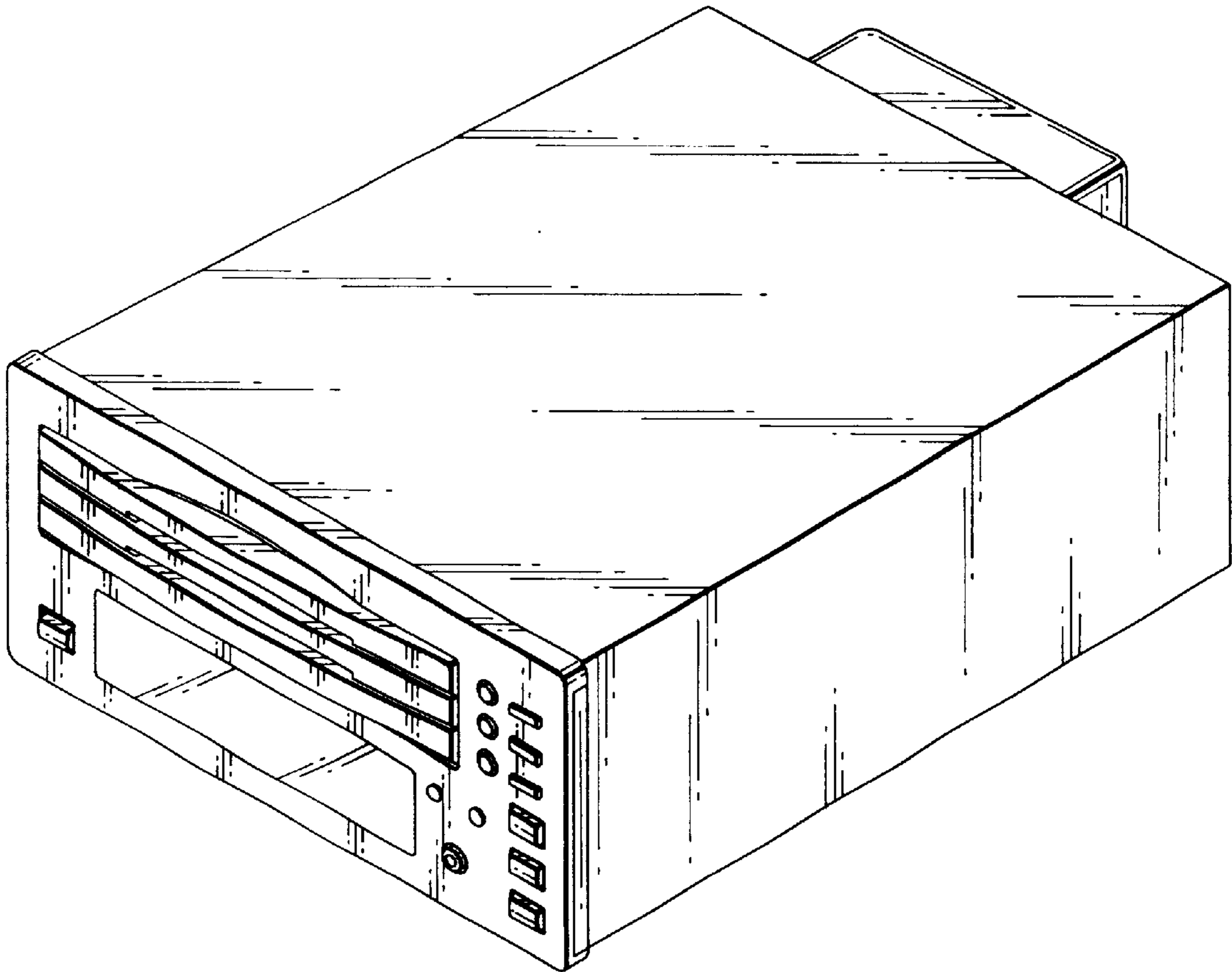

FIG. 1

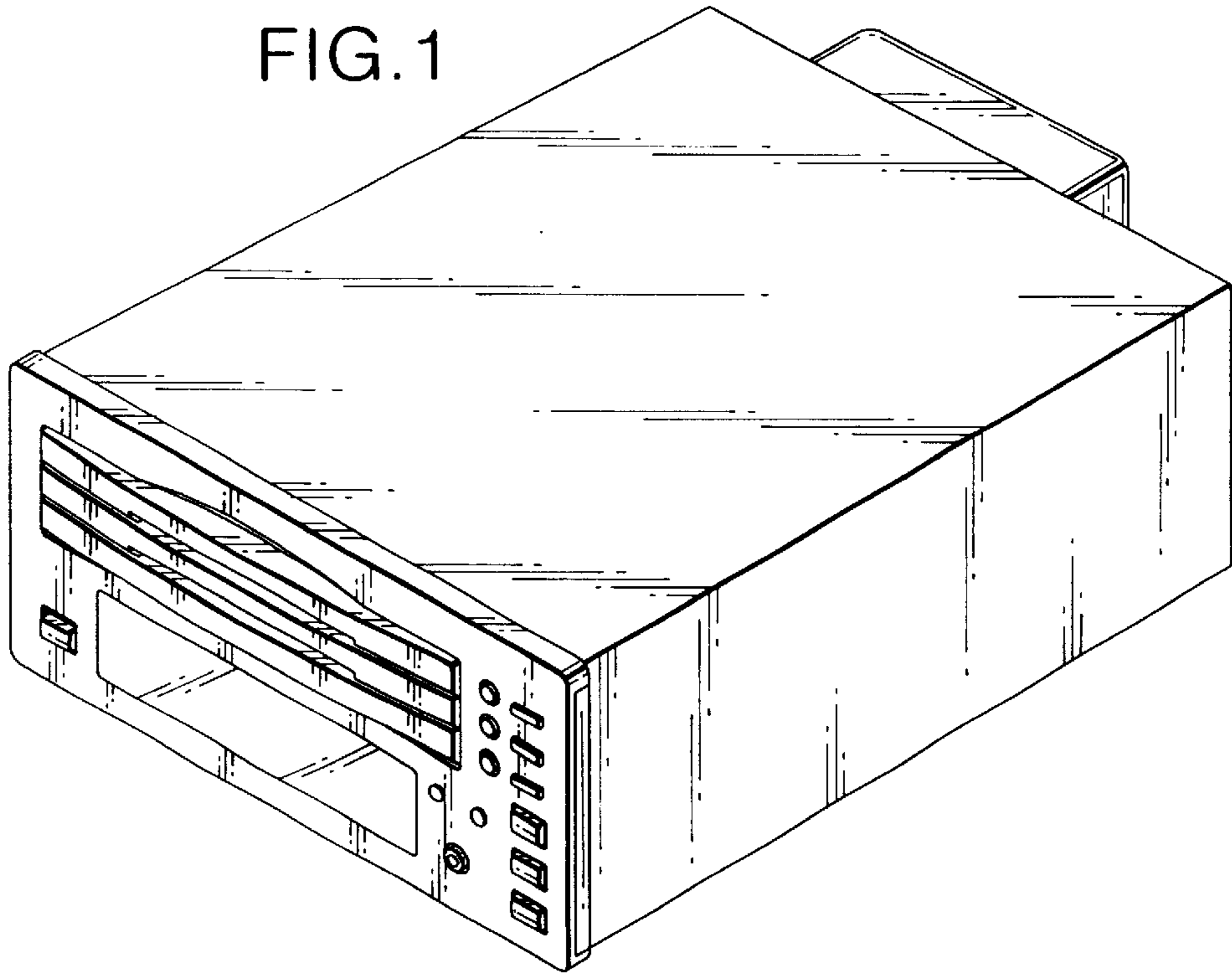

FIG. 2

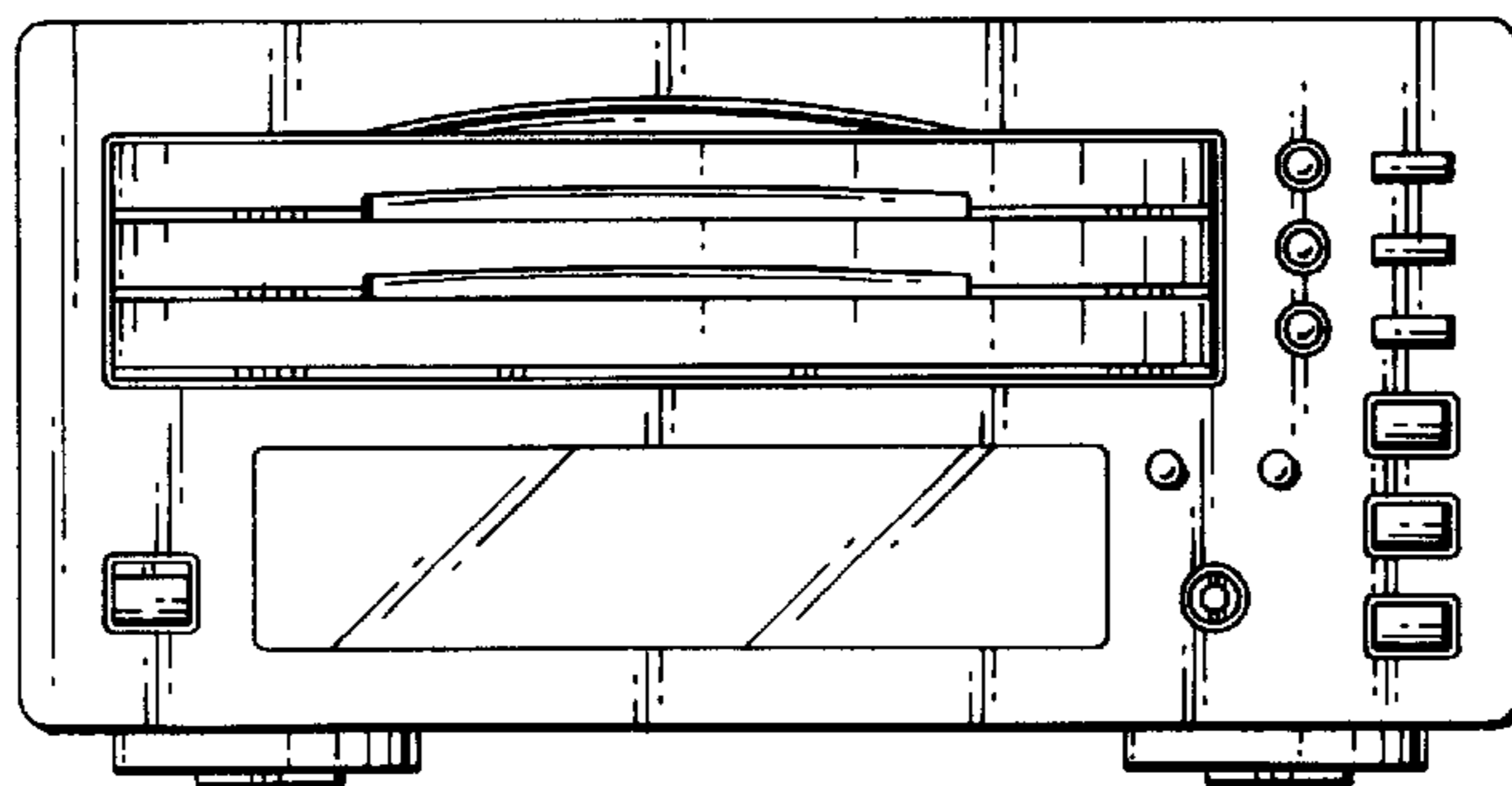

FIG. 3

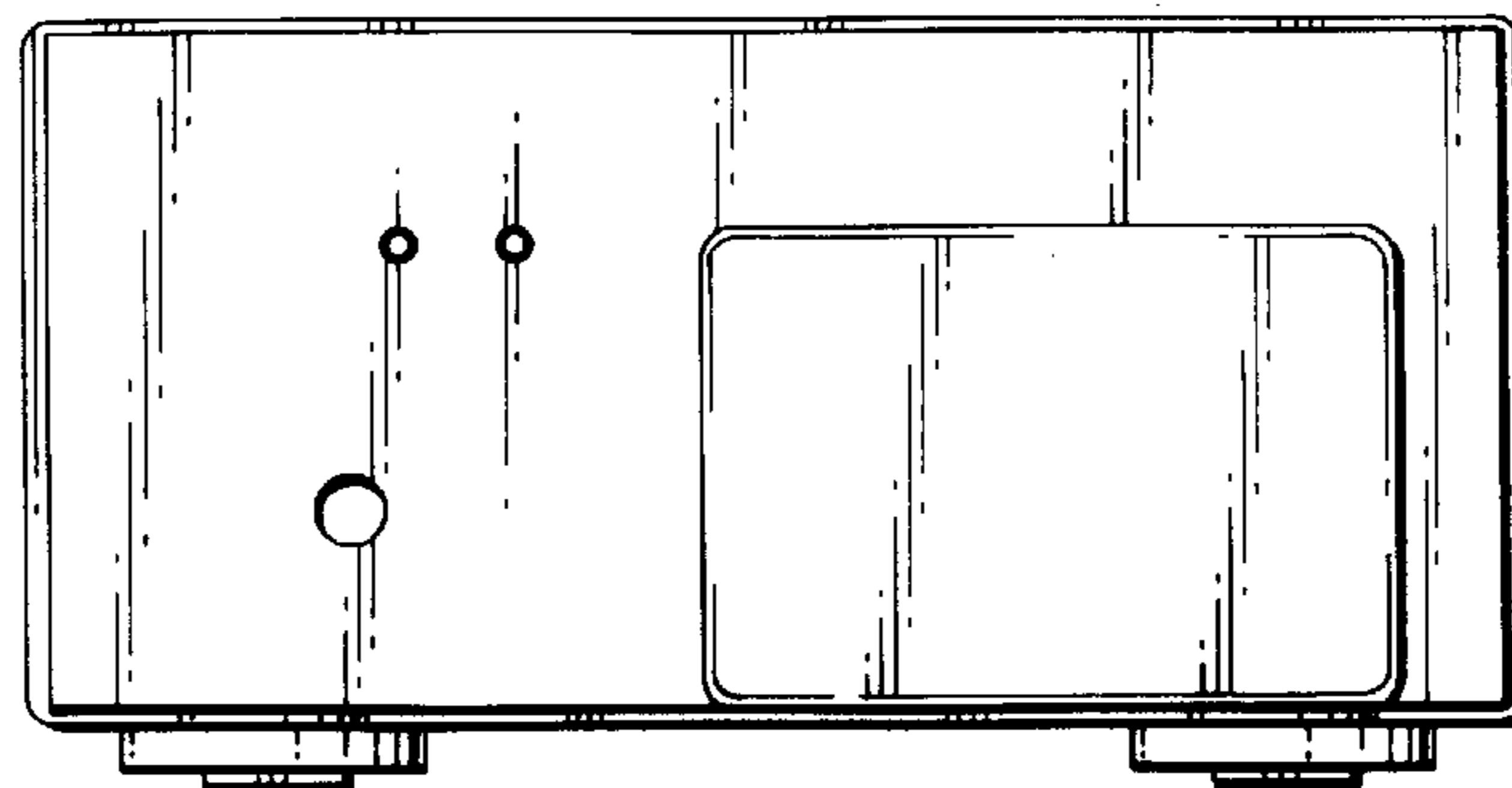

FIG. 4

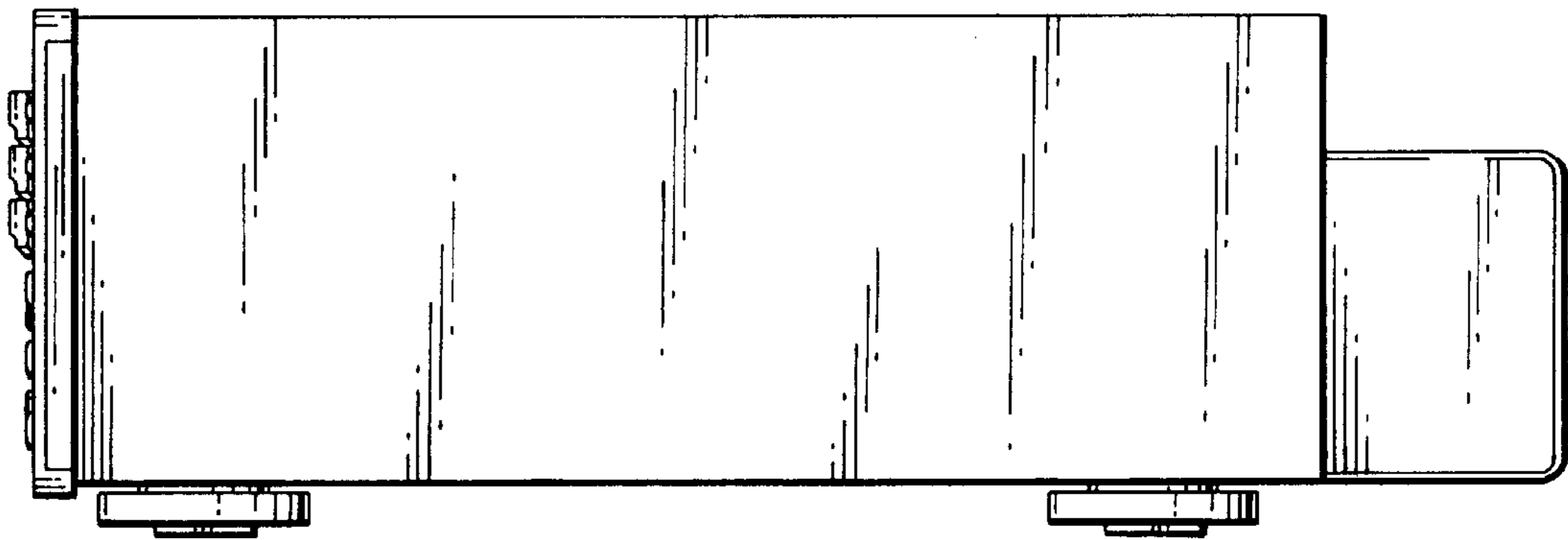

FIG. 5

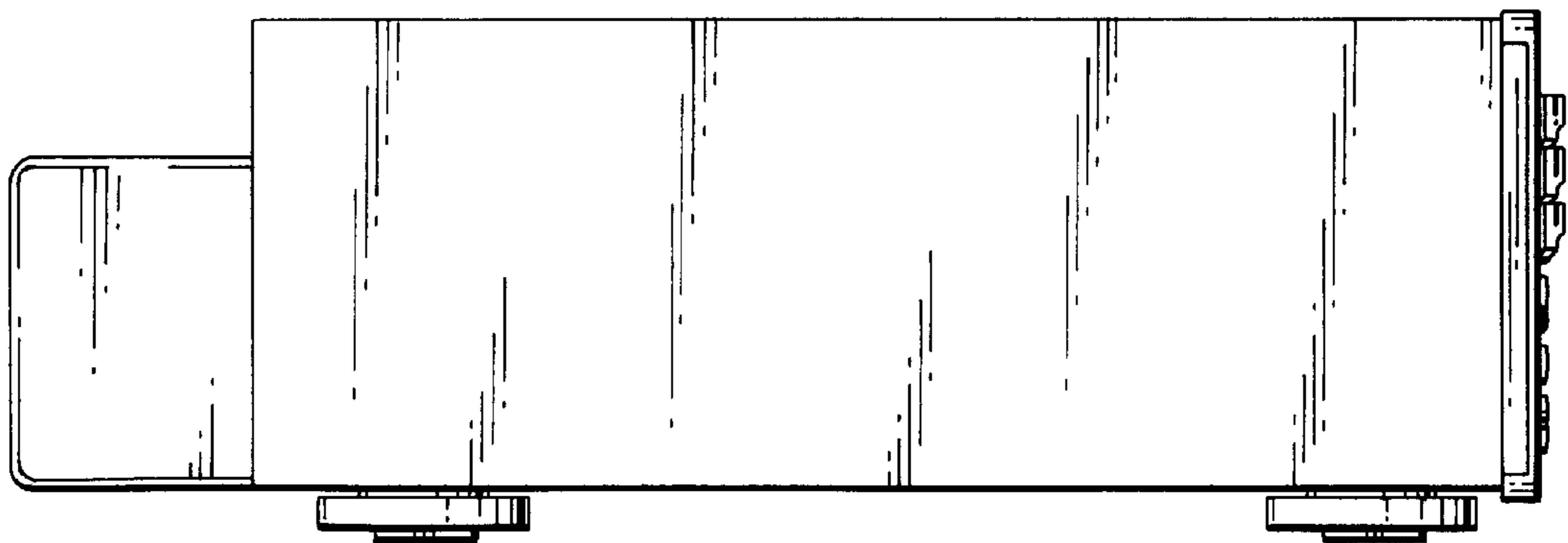

FIG. 6

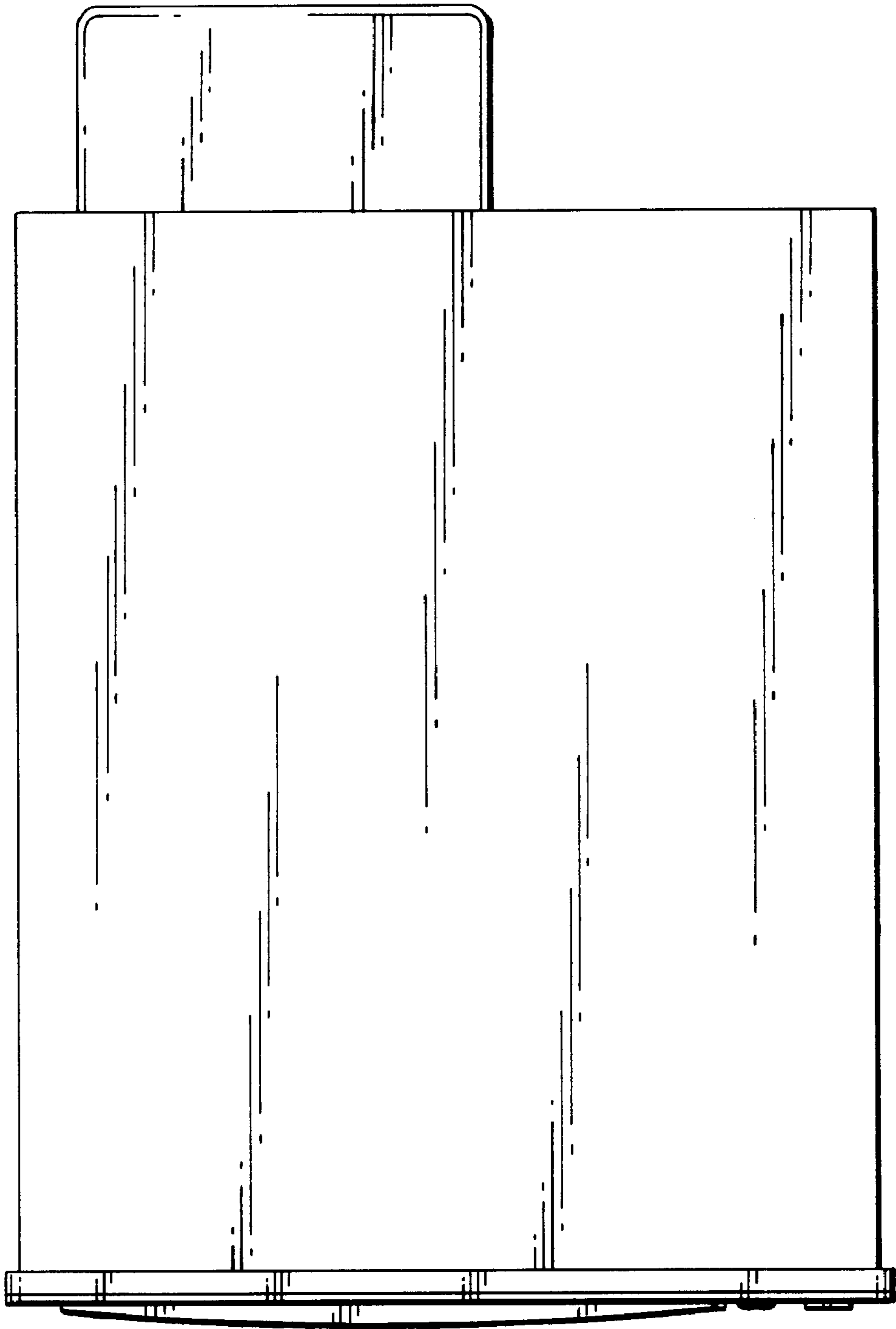

FIG. 7

