



US00D447441B1

(12) **United States Design Patent**
Veach

(10) **Patent No.:** **US D447,441 S**

(45) **Date of Patent:** **** Sep. 4, 2001**

(54) **GOLFING NUT WIRE FIGURINE**

DESCRIPTION

(76) Inventor: **Doug R. Veach**, P.O. Box 725,
Petersburg, WV (US) 26847

(**) Term: **14 Years**

(21) Appl. No.: **29/136,327**

(22) Filed: **Jan. 30, 2001**

(51) **LOC (7) Cl.** **11-02**

(52) **U.S. Cl.** **D11/160**

(58) **Field of Search** D11/131, 157,
D11/160; D21/621, 635; 446/385, 386

(56) **References Cited**

U.S. PATENT DOCUMENTS

D. 213,406	*	2/1969	Davis	D11/160	X
D. 215,305	*	9/1969	Petito	D11/160	
D. 247,483	*	3/1978	Slater	D11/160	
D. 262,554	*	1/1982	Matsui	D11/160	X
D. 329,827	*	9/1992	Hollinger	D11/160	
D. 341,103	*	11/1993	Domenig	D11/160	X
D. 342,696	*	12/1993	Martin	D11/160	X
D. 366,505	*	1/1996	Dowdy et al.	D11/160	X
D. 436,890	*	1/2001	Falco	D11/160	

* cited by examiner

Primary Examiner—Dominic Simone

(74) *Attorney, Agent, or Firm*—Bradley D. Goldizen;
Pender & Coward, P.C.

(57) **CLAIM**

The ornamental design for a golfing nut wire figurine, as shown and described.

FIG. 1 is a front elevation view of a golfing nut wire figurine or similar article showing my new design;
 FIG. 2 is a rear elevation view of FIG. 1;
 FIG. 3 is a side elevation view taken from the left of FIG. 1;
 FIG. 4 is a side elevation view taken from the right of FIG. 1;
 FIG. 5 is a top plan view of FIG. 1;
 FIG. 6 is a bottom plan view of FIG. 1;
 FIG. 7 is a front elevation view of a second embodiment of the design of FIG. 1;
 FIG. 8 is a rear elevation view of FIG. 7;
 FIG. 9 is a side elevation view taken from the left of FIG. 7;
 FIG. 10 is a side elevation view taken from the right of FIG. 7;
 FIG. 11 is a top plan view of FIG. 7;
 FIG. 12 is a bottom plan view of FIG. 7;
 FIG. 13 is a front elevation view of a third embodiment of the design of FIG. 1;
 FIG. 14 is a rear elevation view of FIG. 13;
 FIG. 15 is a side elevation view taken from the left of FIG. 13;
 FIG. 16 is a side elevation view taken from the right side of FIG. 13;
 FIG. 17 is a top plan view of FIG. 13; and,
 FIG. 18 is a bottom plan view of FIG. 13.
 The broken line showing of the legible matter is for illustrative purposes only and forms no part of the claimed design.

1 Claim, 9 Drawing Sheets

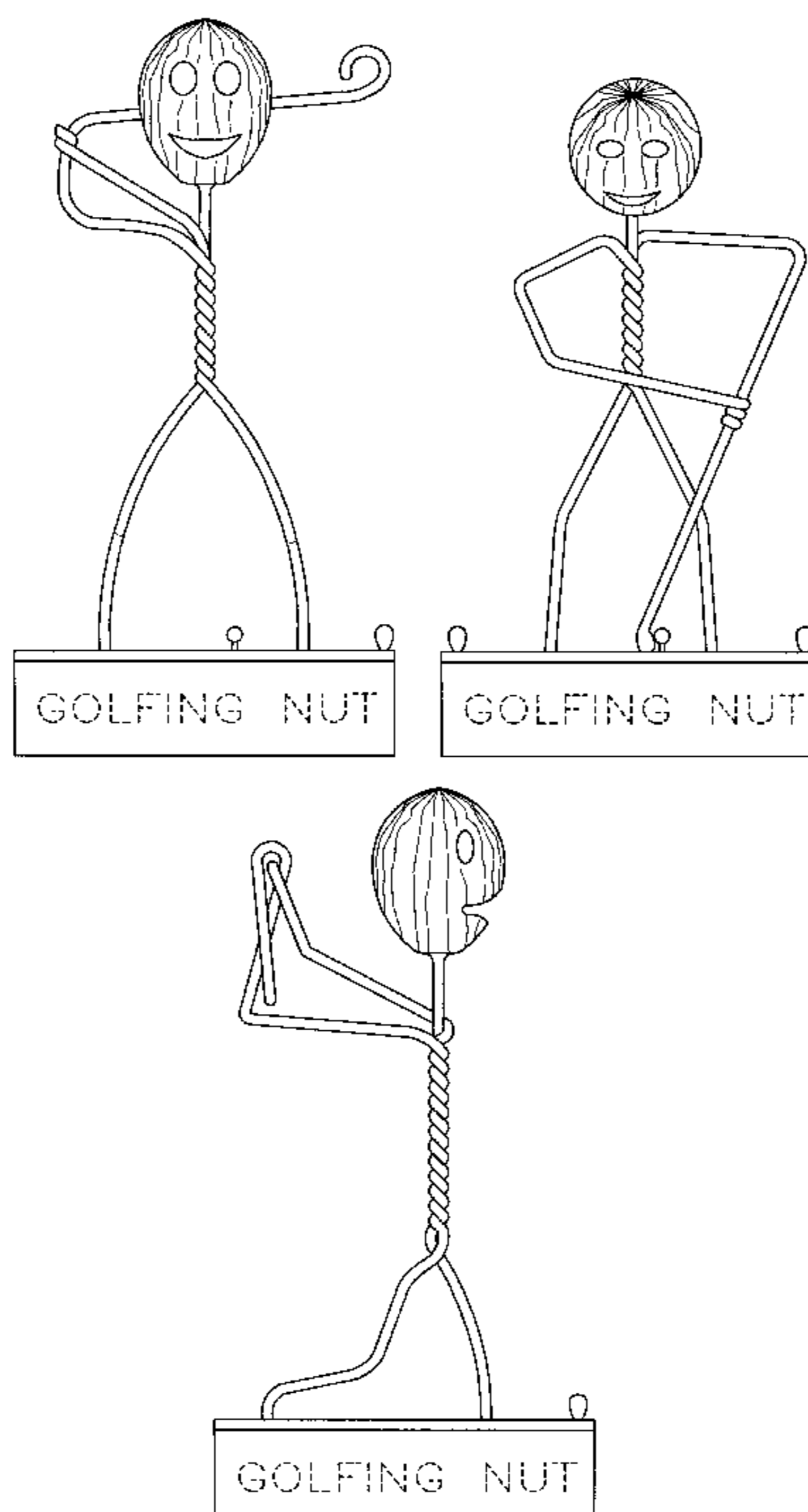

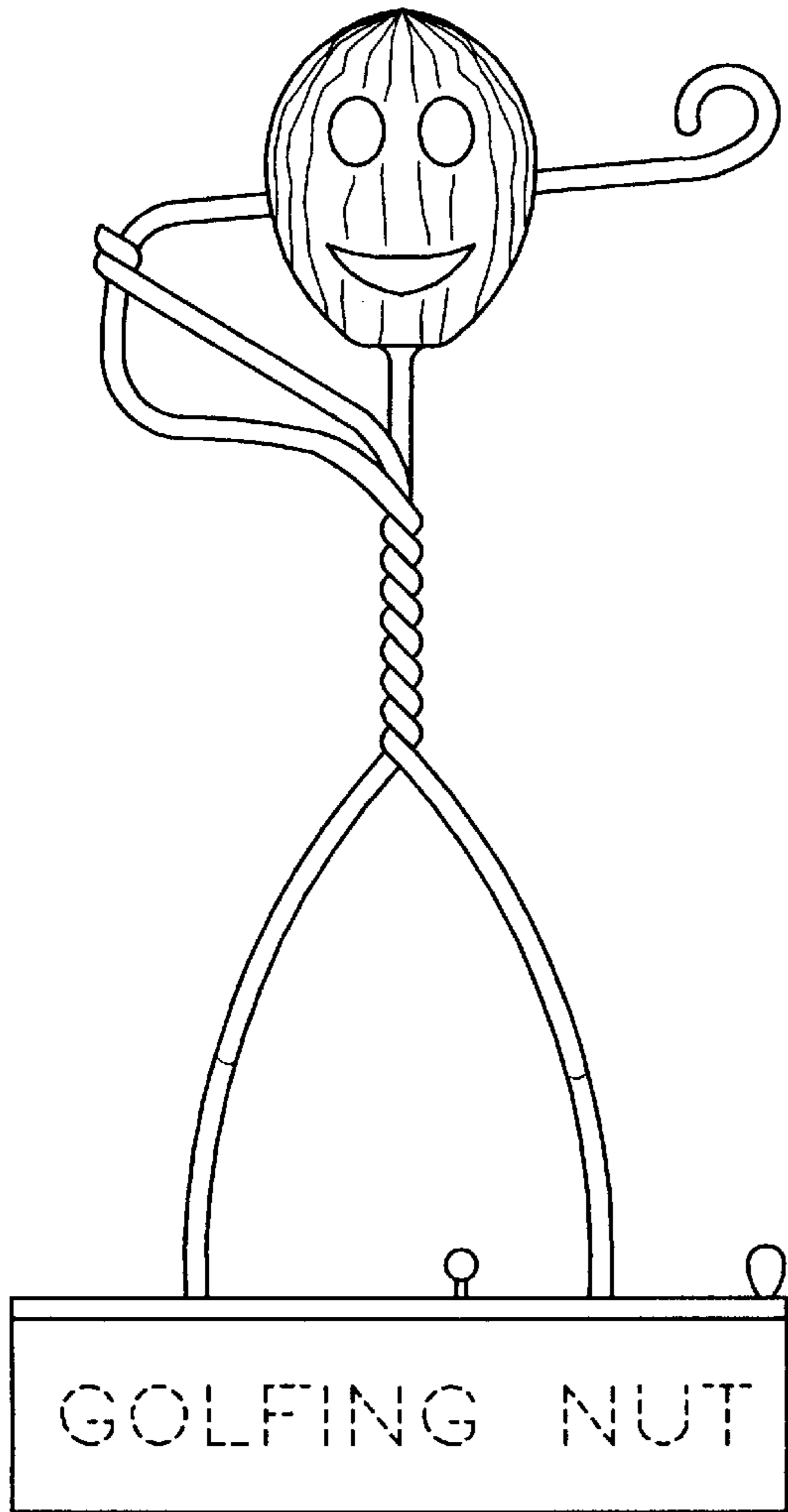

FIG. 1 FRONT

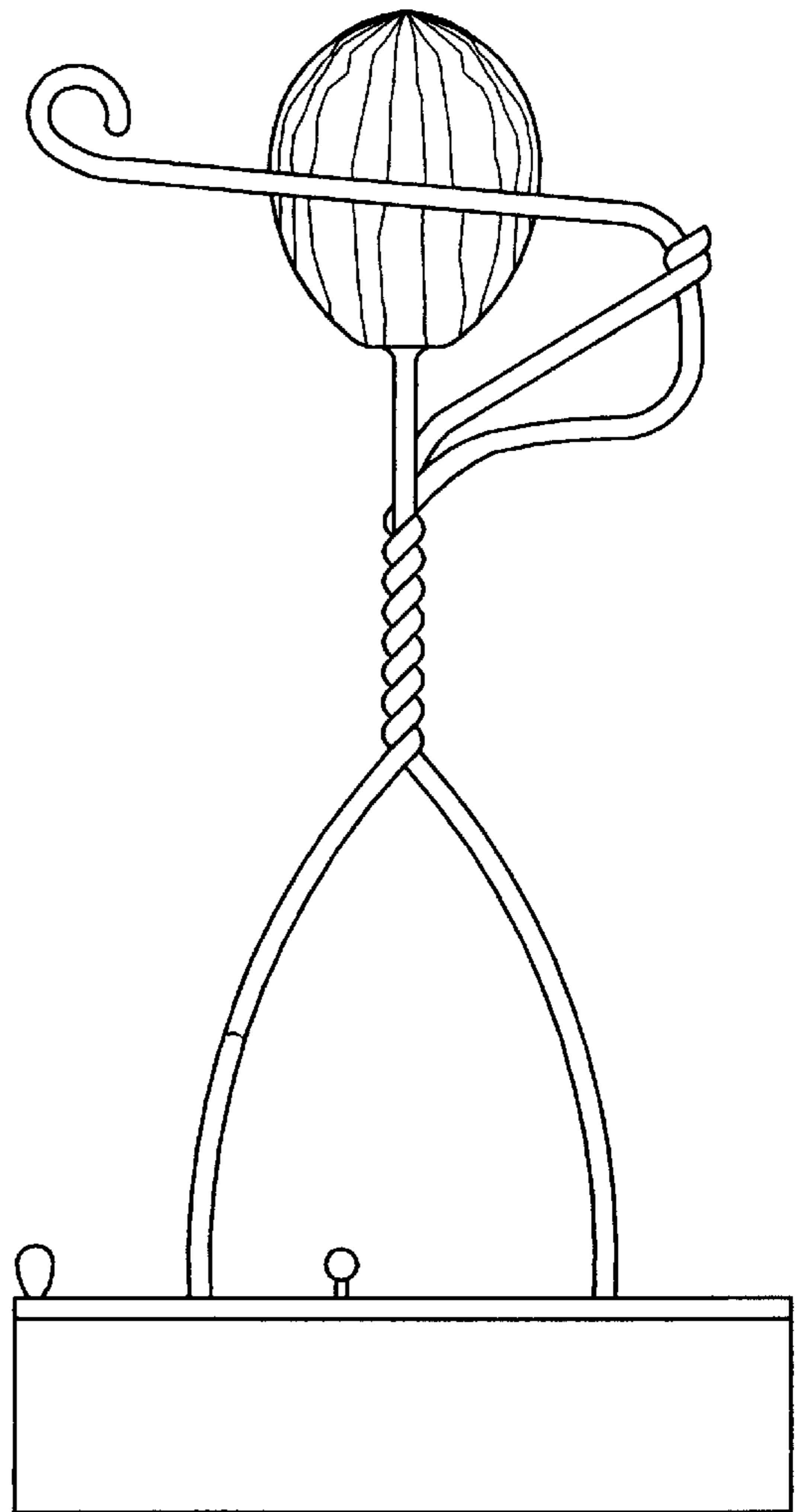

FIG. 2 BACK

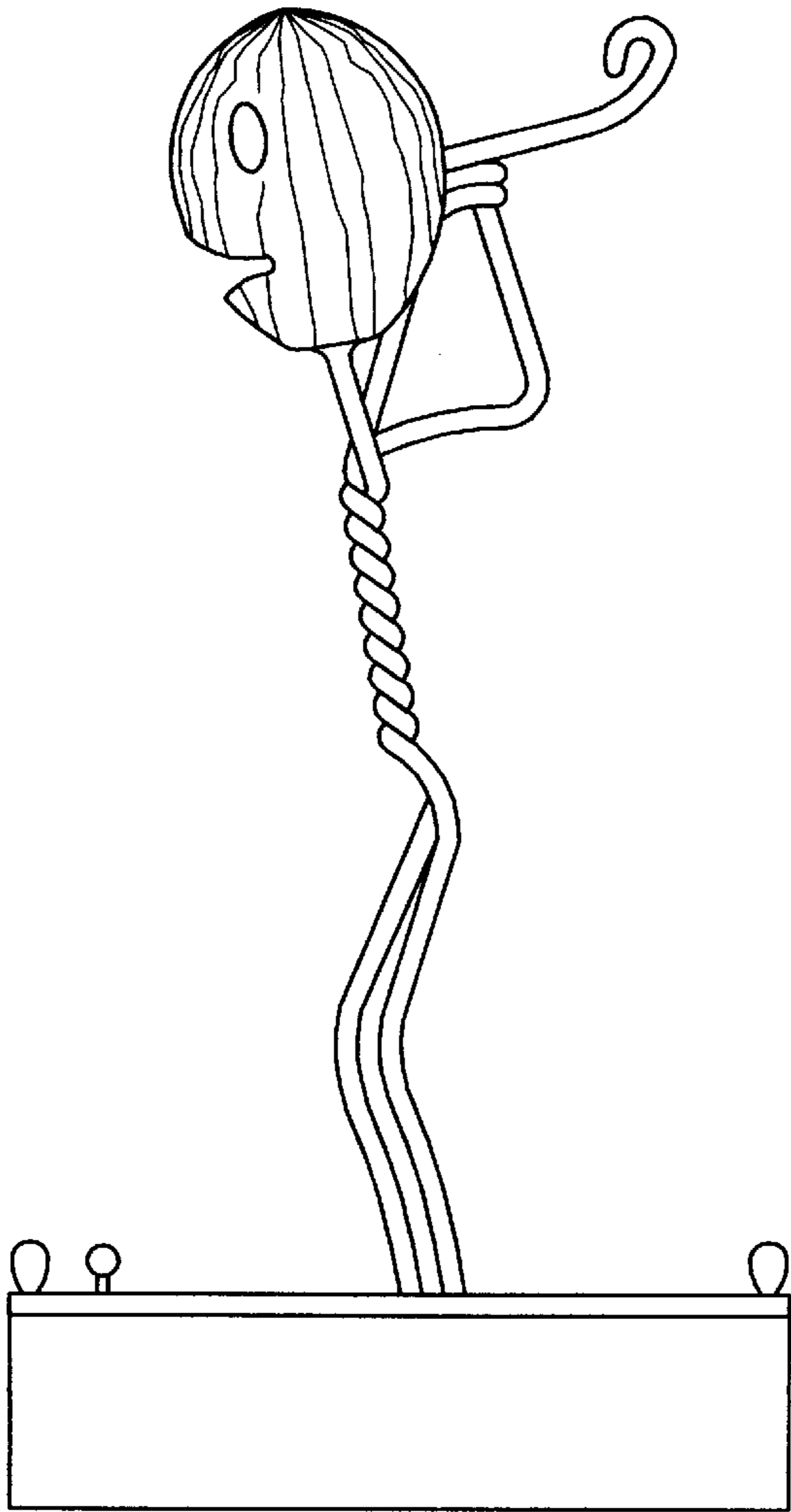

FIG. 3 LEFT

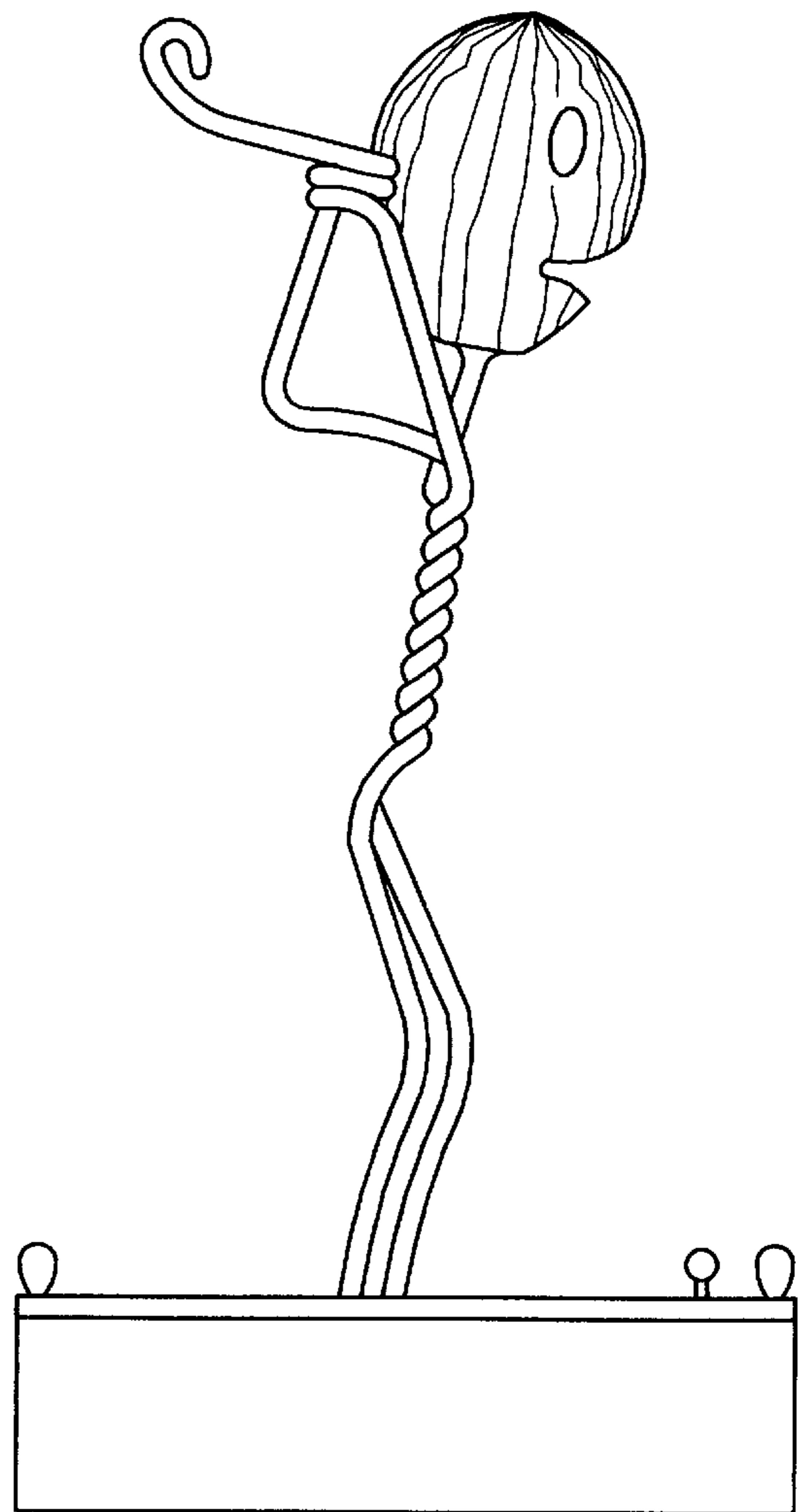

FIG. 4 RIGHT

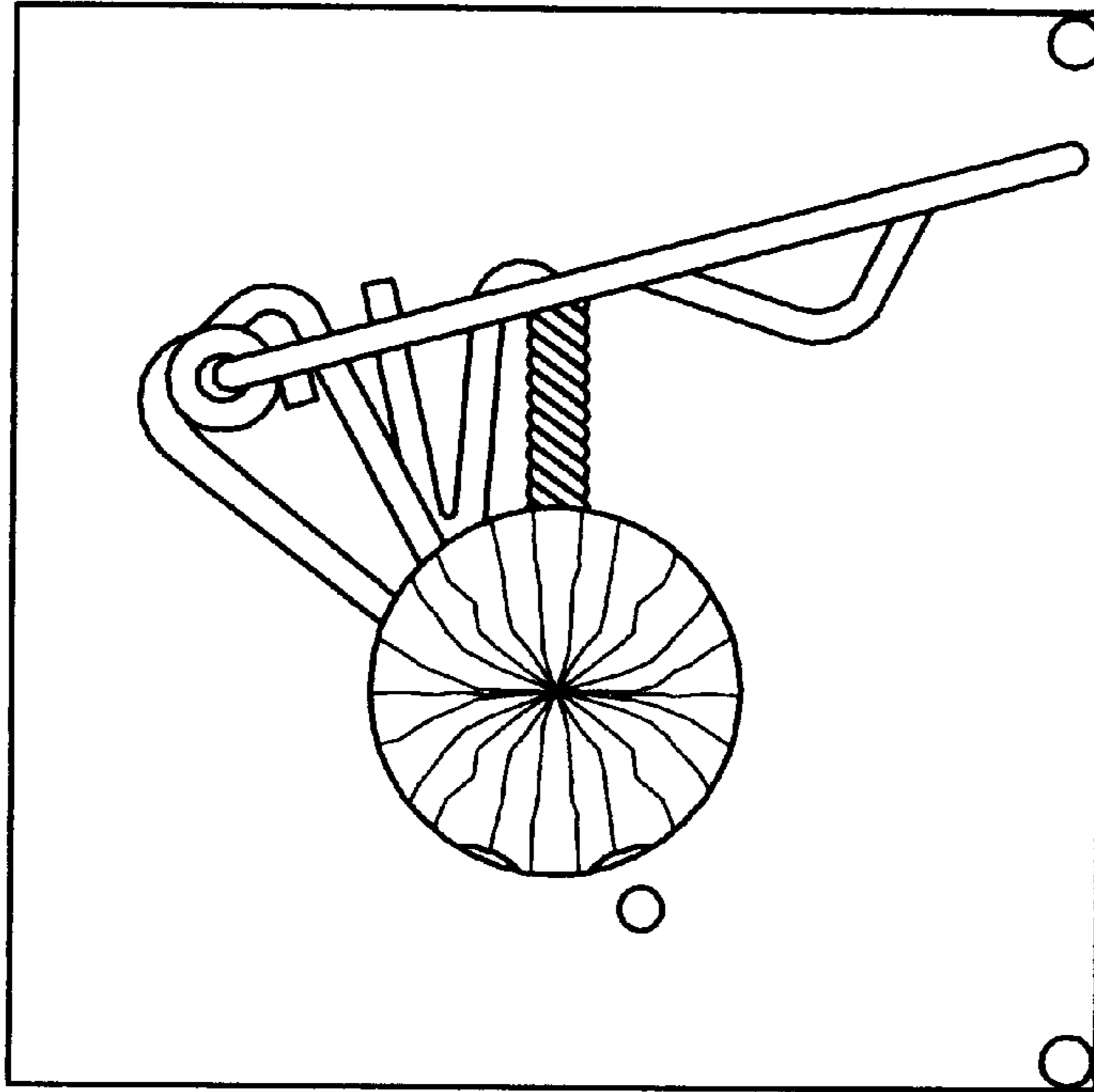

FIG. 5 TOP

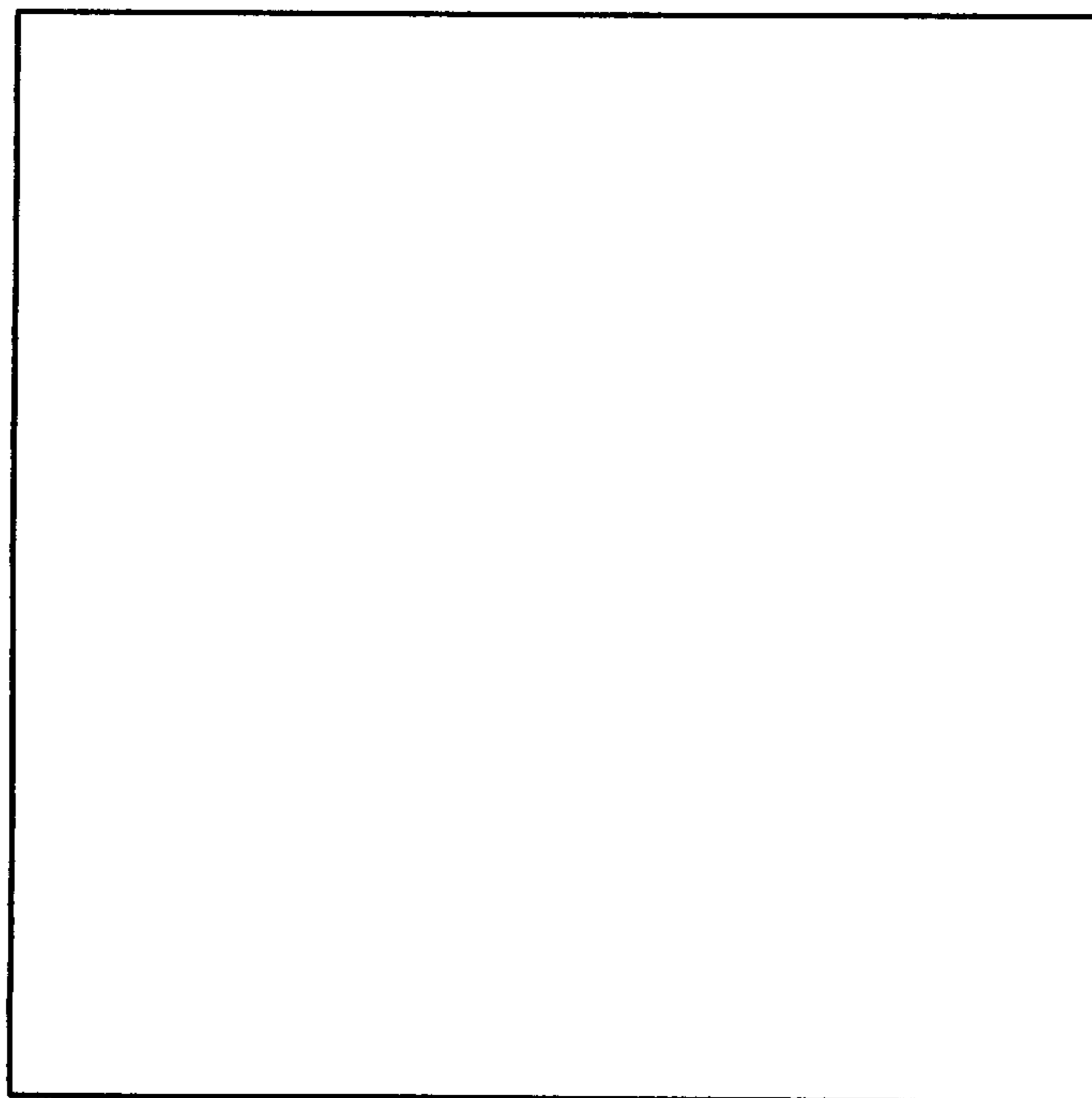

FIG. 6 BOTTOM

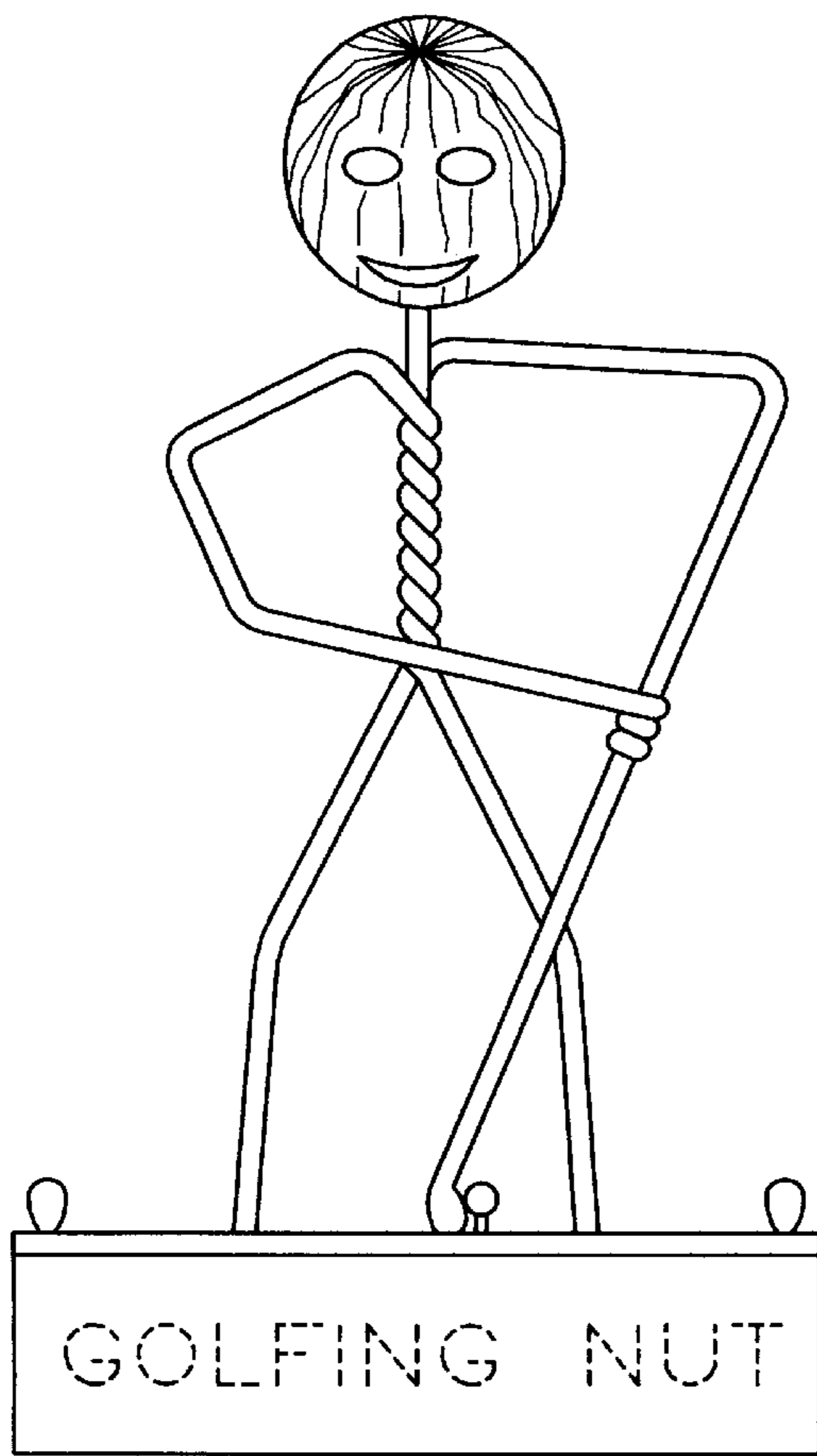

FIG. 7 FRONT

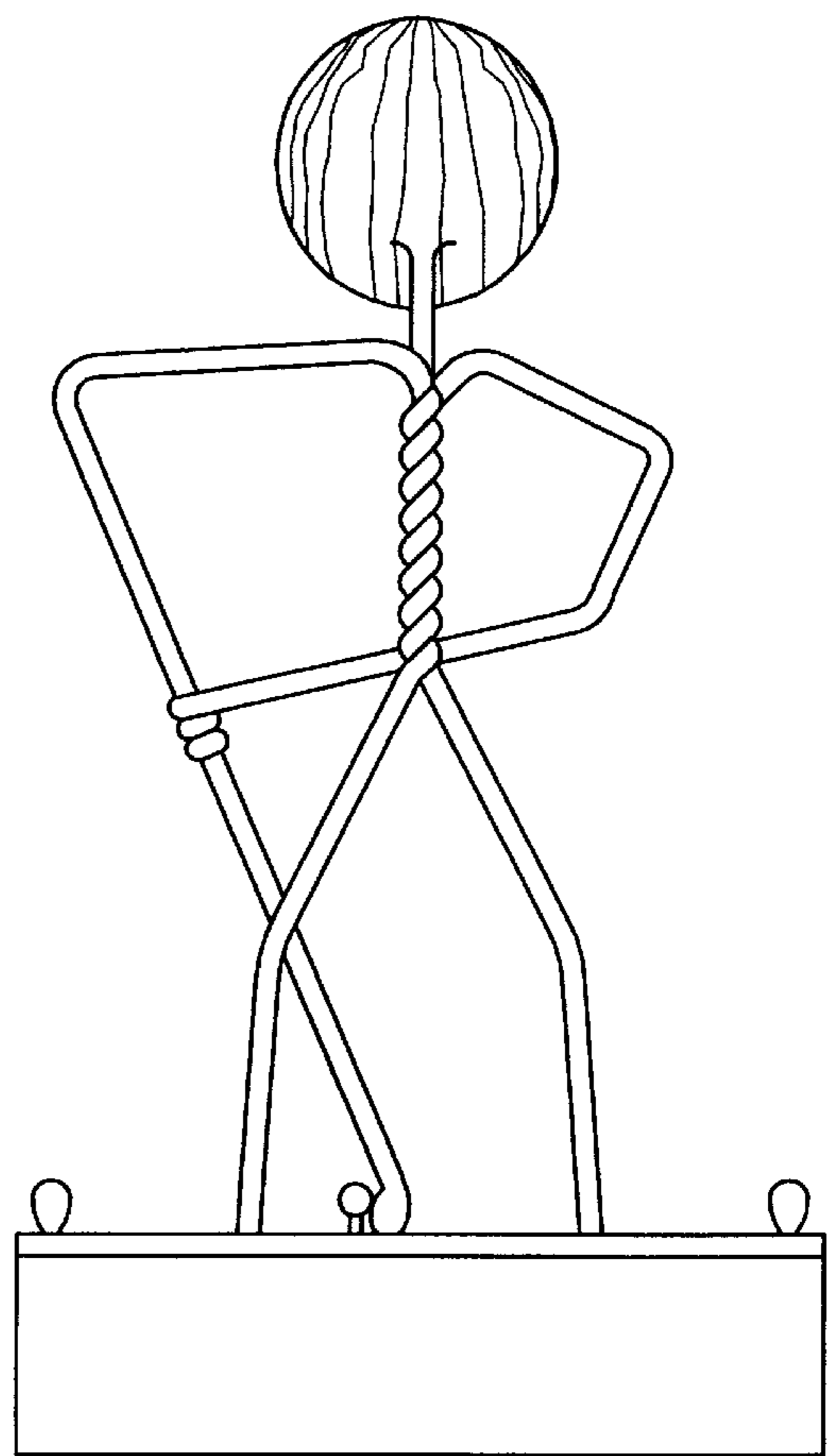

FIG. 8 BACK

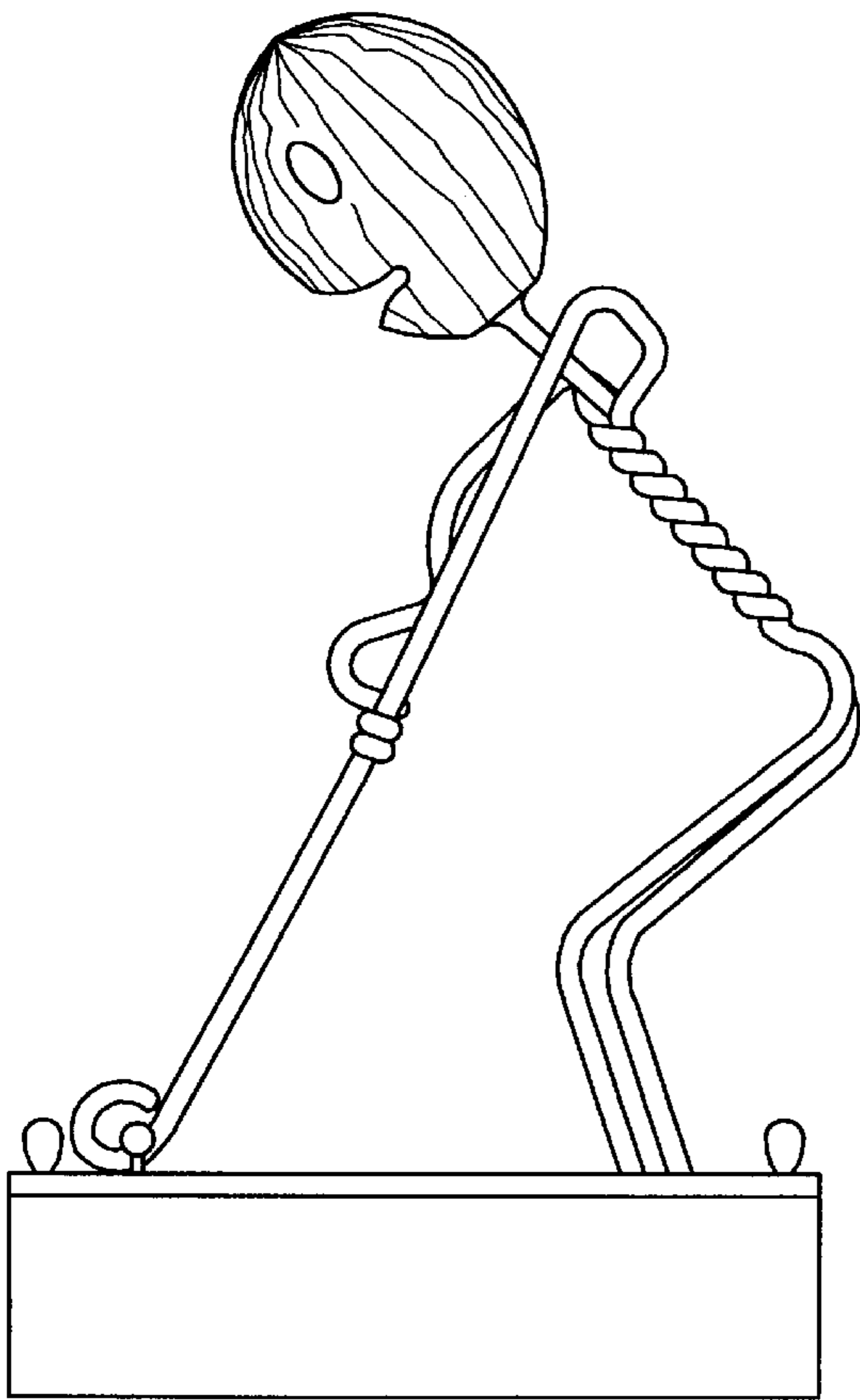

FIG. 9 LEFT

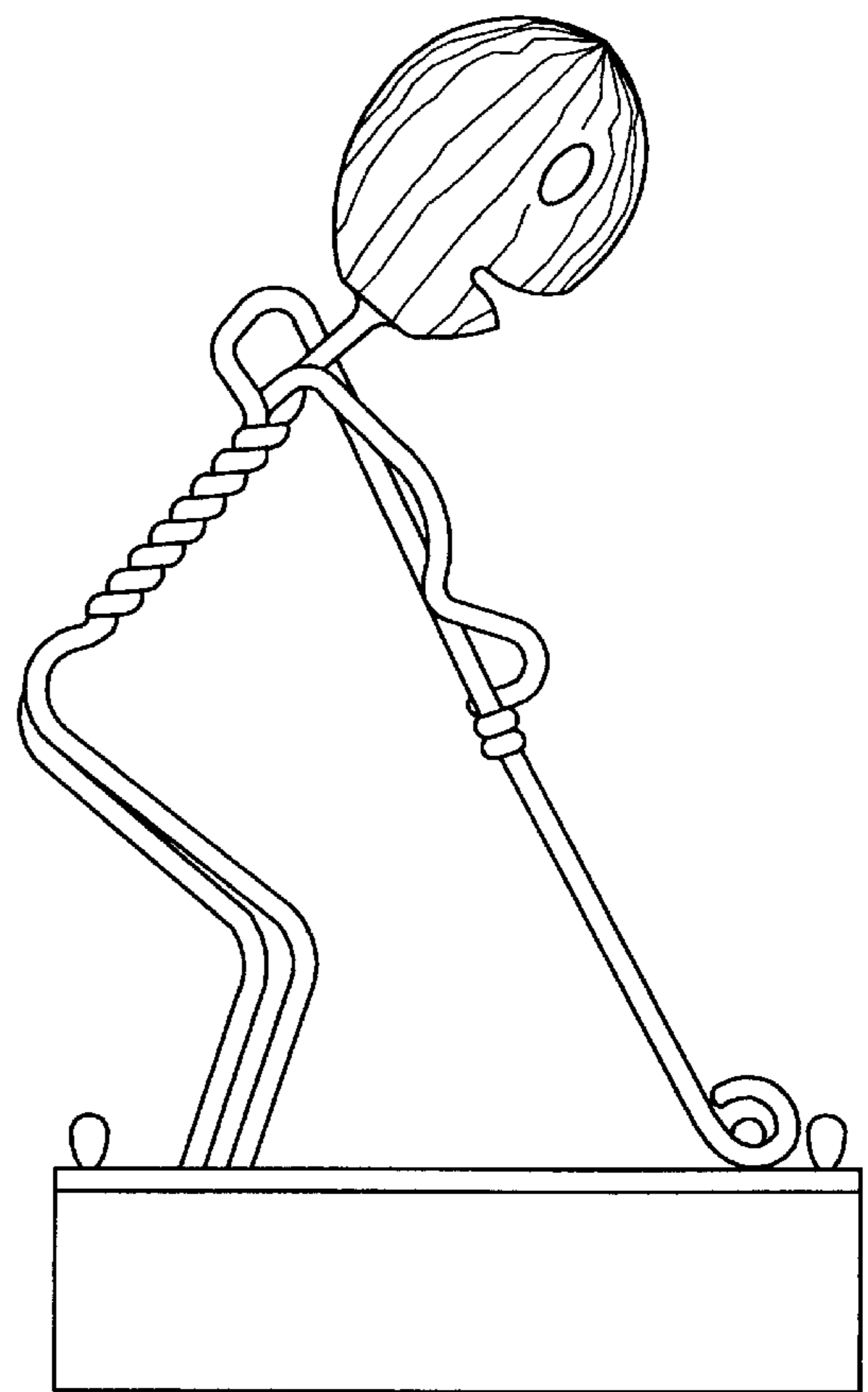

FIG. 10 RIGHT

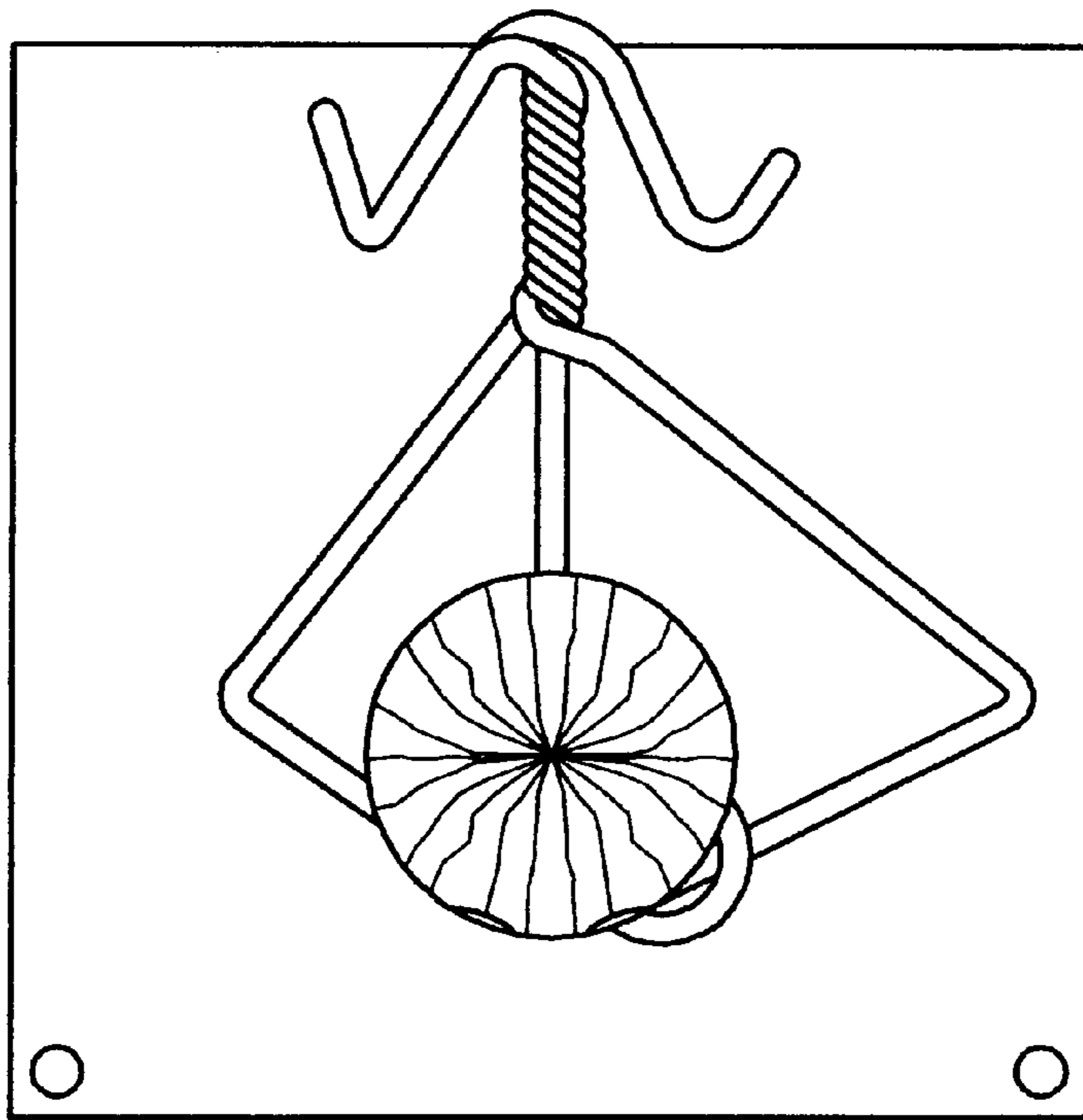

FIG. 11 TOP

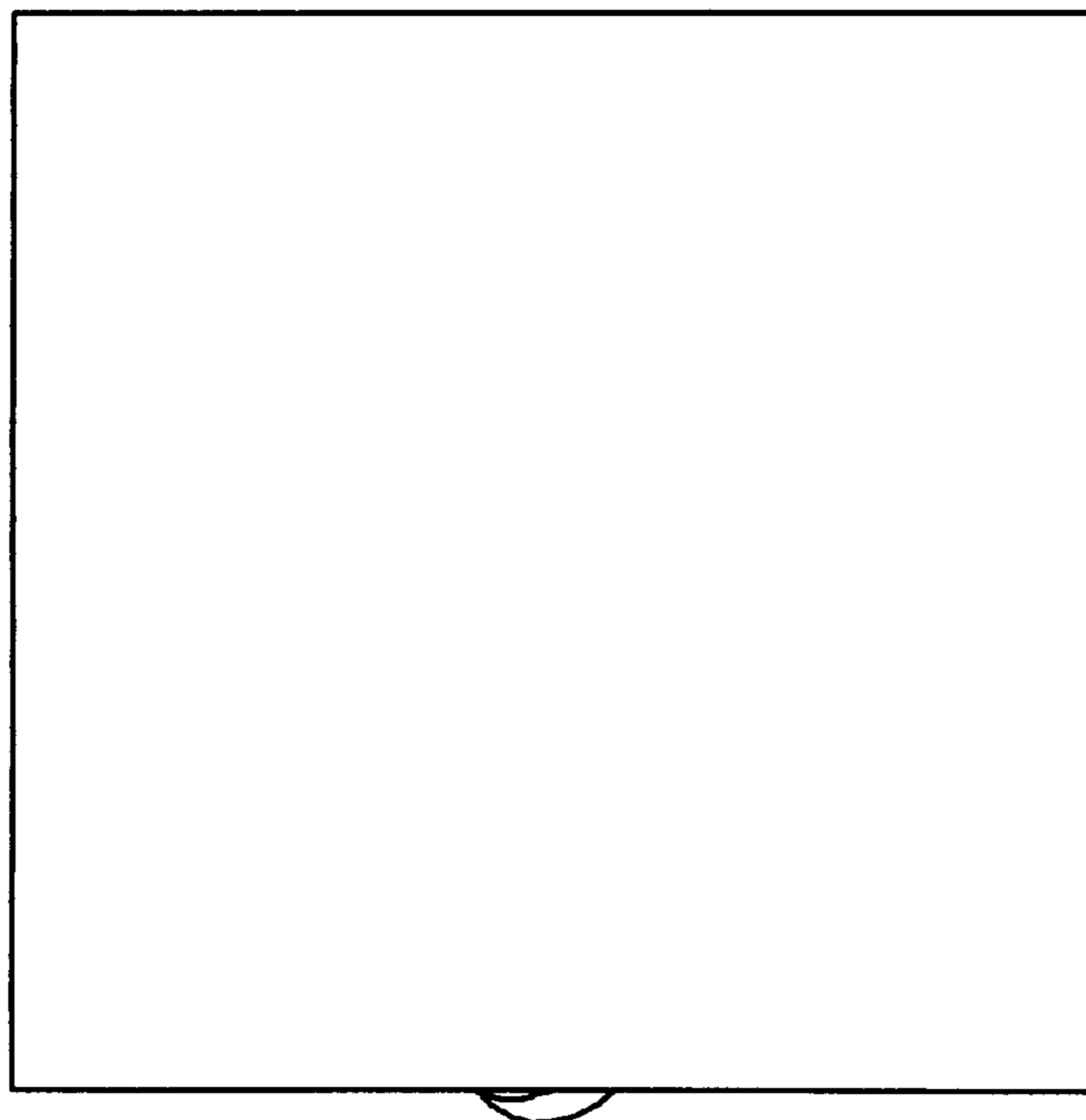

FIG. 12 BOTTOM

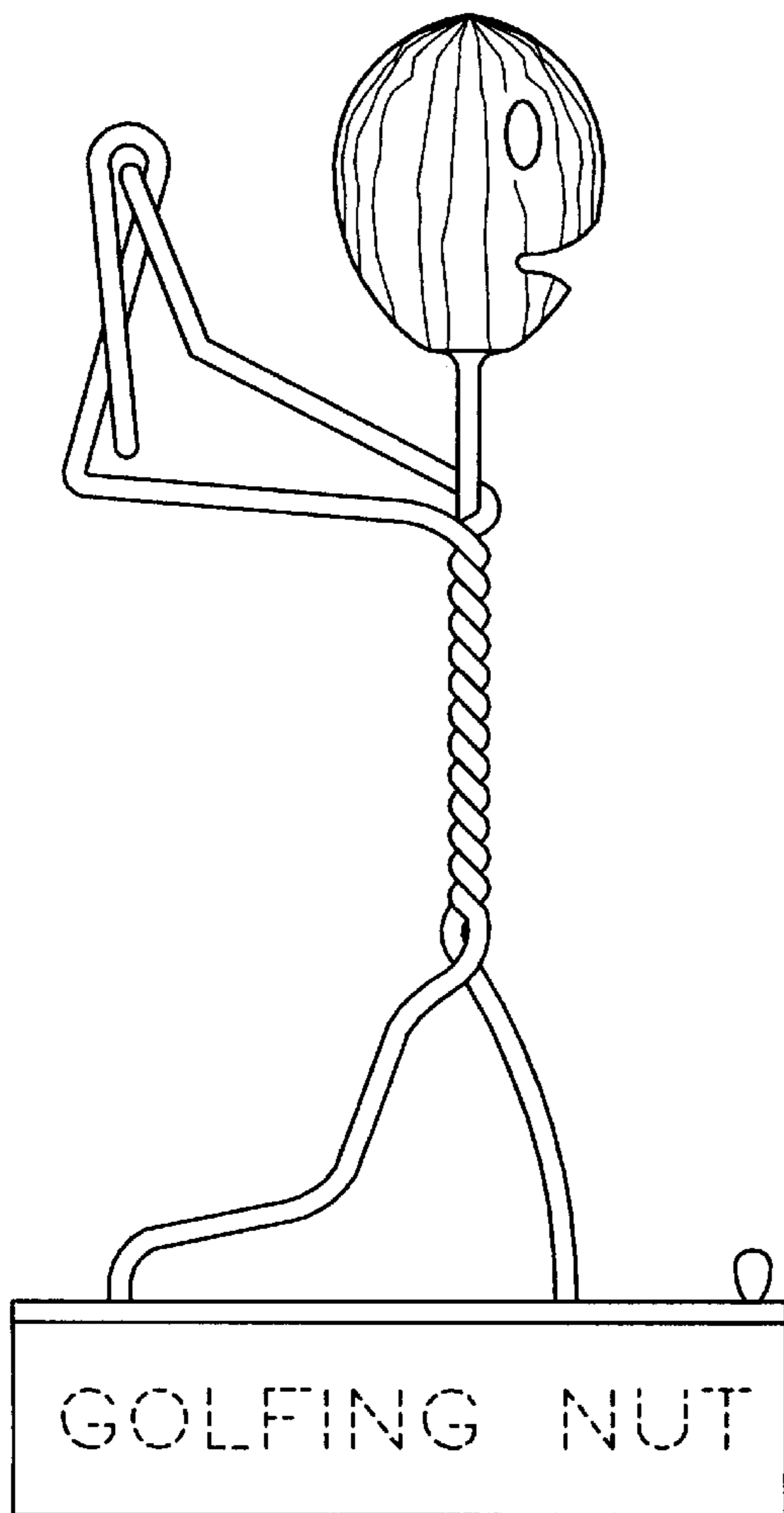

FIG. 13 FRONT

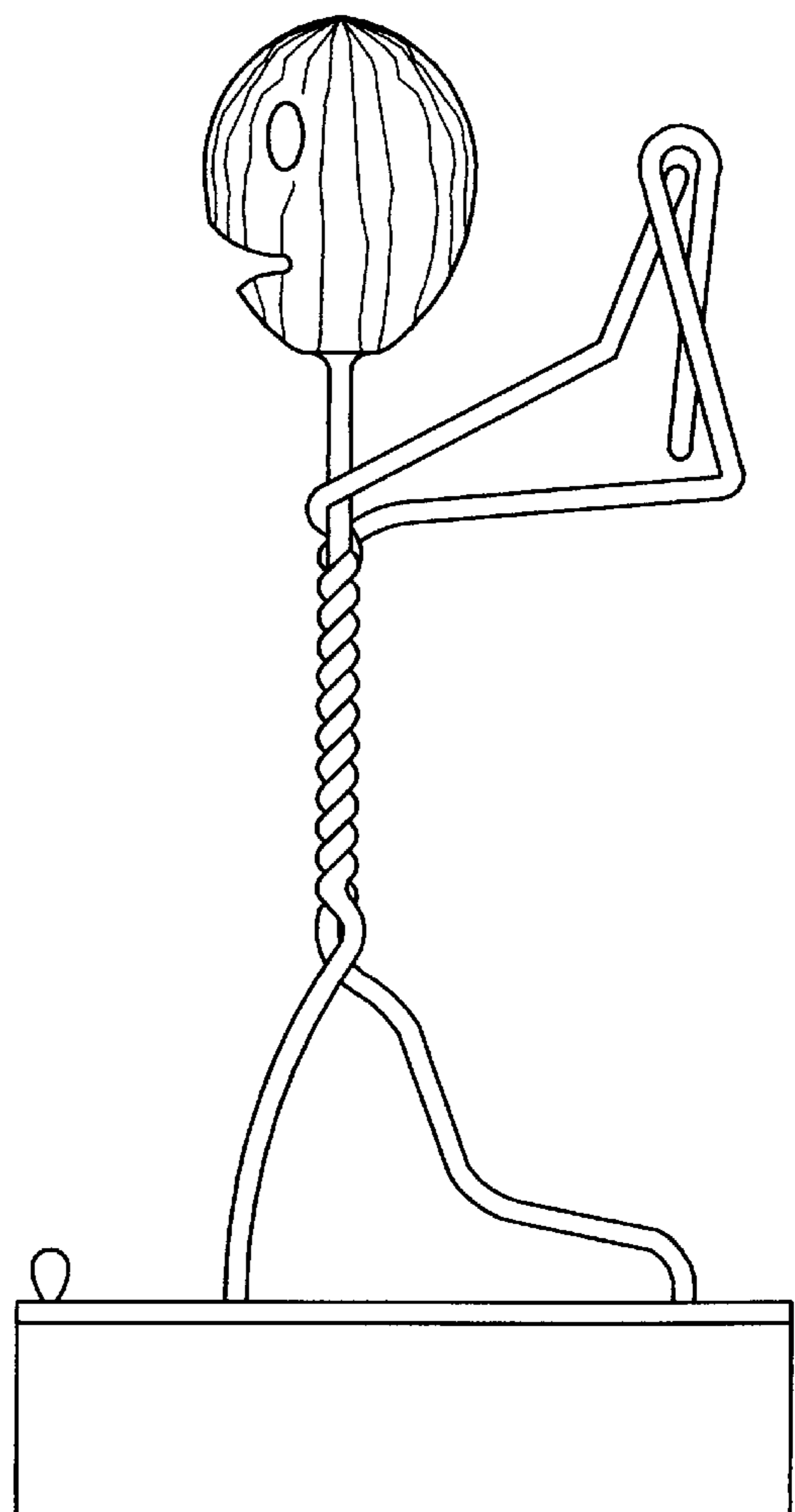

FIG. 14 BACK

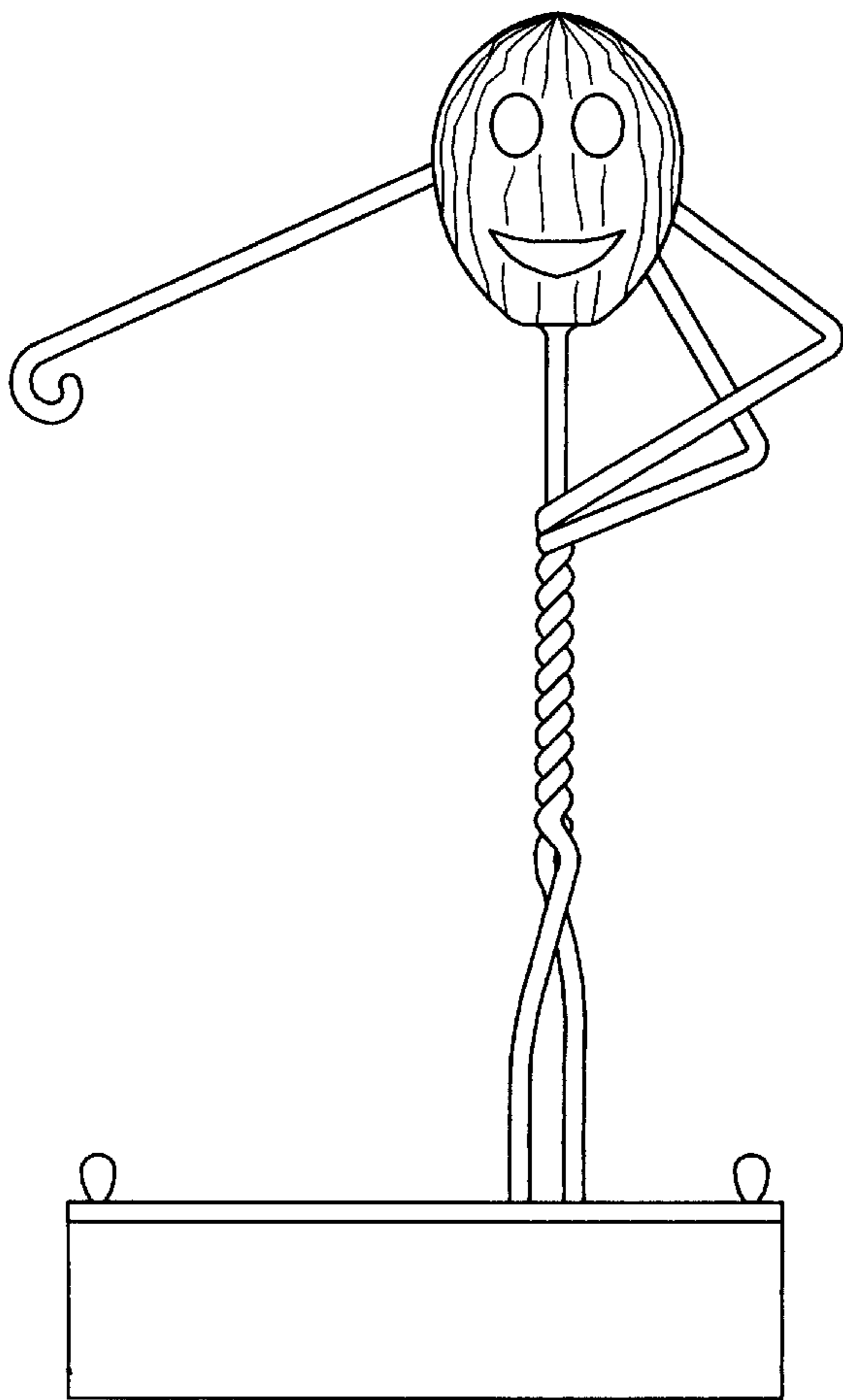

FIG. 15 LEFT

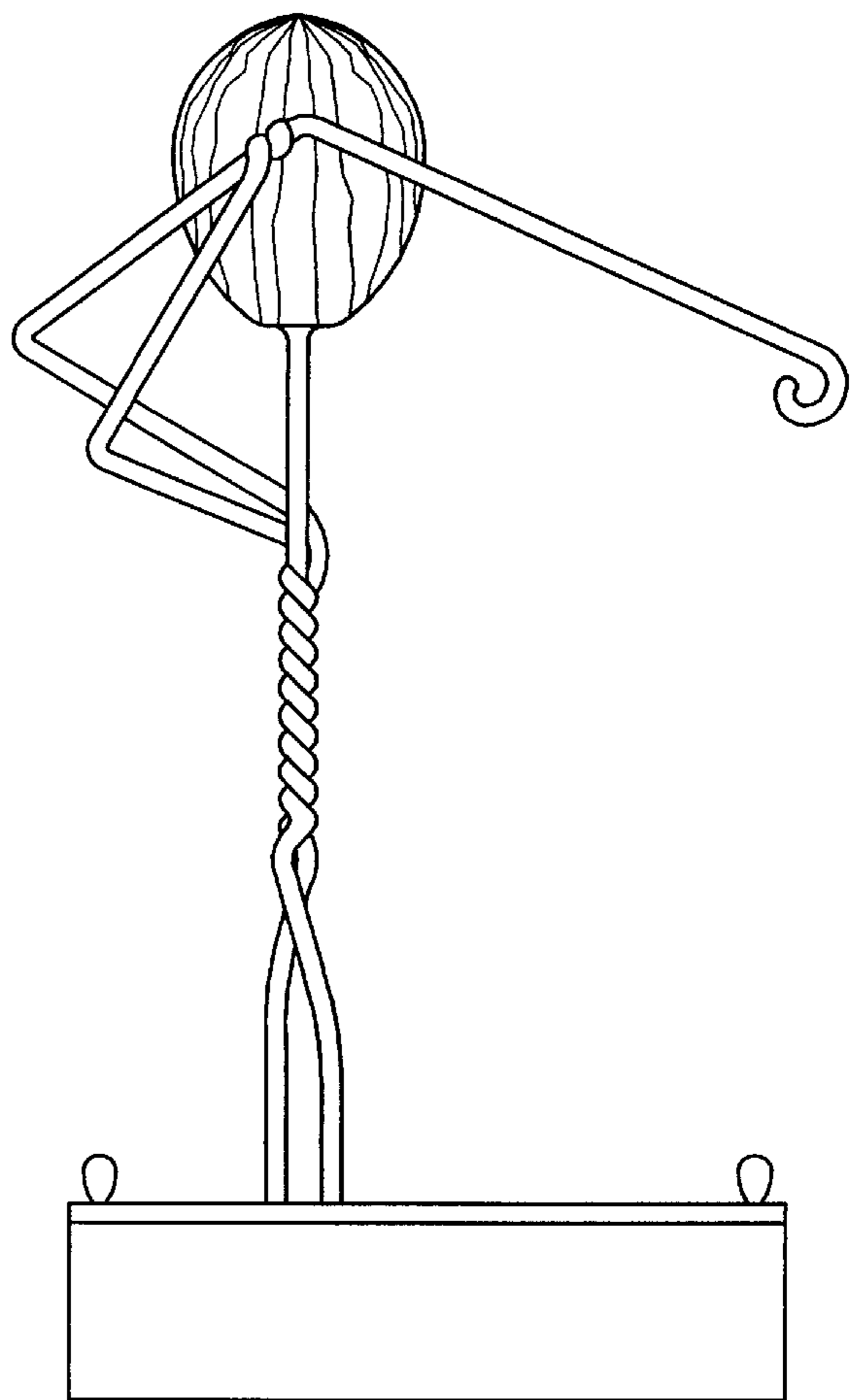

FIG. 16 RIGHT

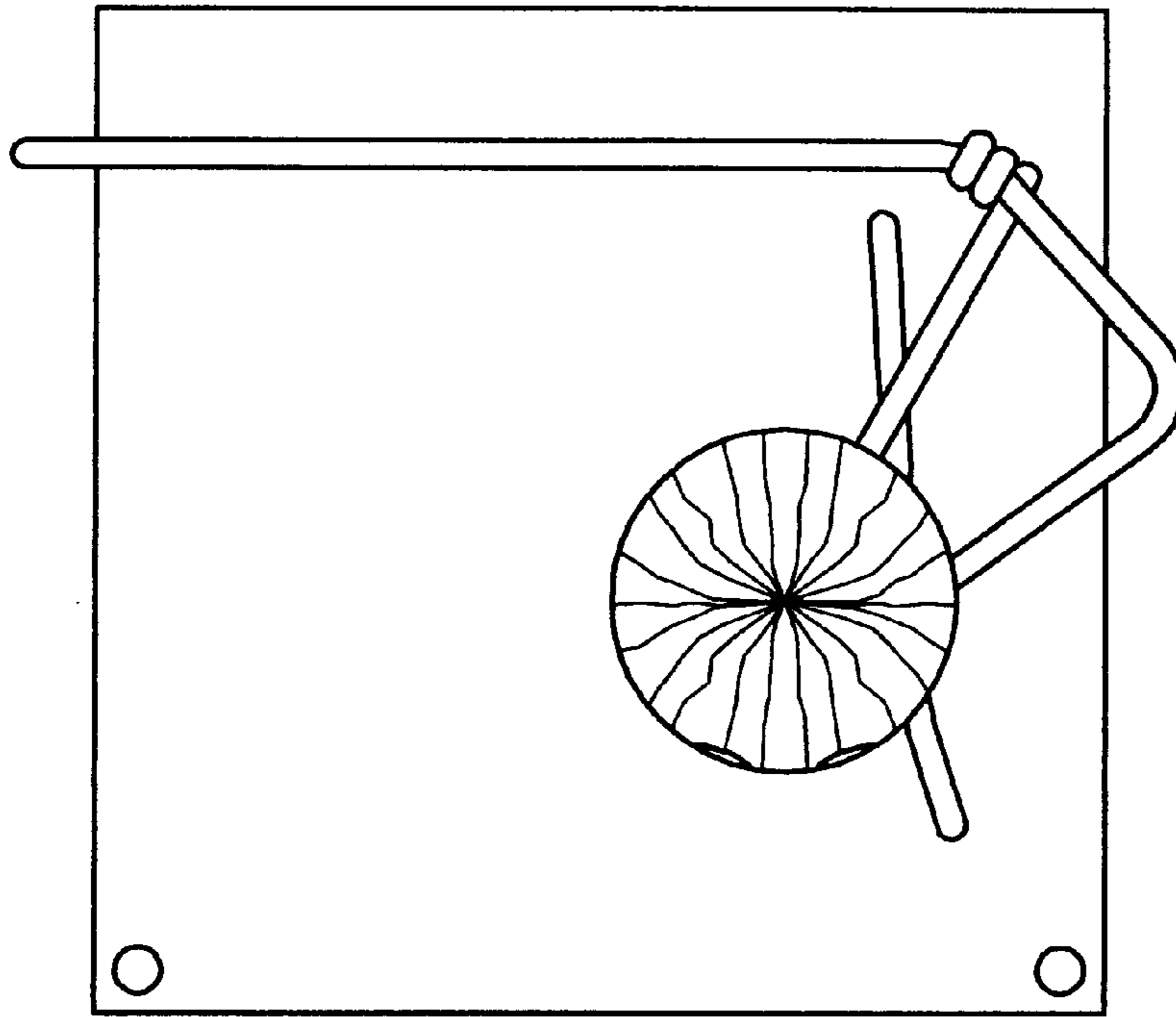

FIG. 17 TOP

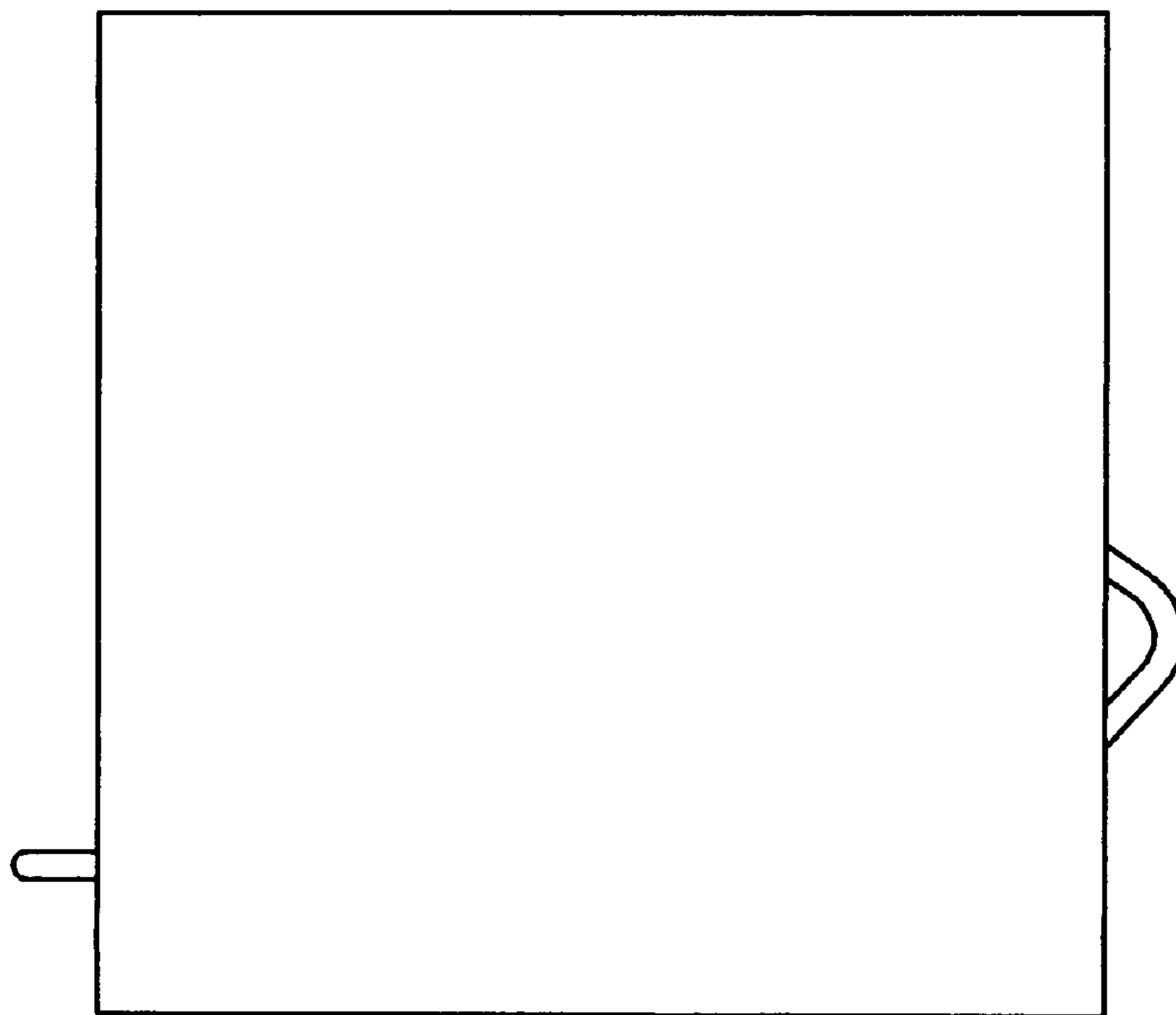

FIG. 18 BOTTOM