



US00D447413B1

(12) **United States Design Patent**
DuCorday

(10) **Patent No.:** **US D447,413 S**

(45) **Date of Patent:** **** Sep. 4, 2001**

(54) **BAG CLOSURE WITH SNAP-OPEN HANDLE**

Primary Examiner—Cathron C. Brooks

(76) Inventor: **Gerard M. DuCorday**, 10871 Thorley Rd., Santa Ana, CA (US) 92705

(57) **CLAIM**

(**) Term: **14 Years**

The ornamental design for a “bag closure with snap-open handle”, as shown and described.

(21) Appl. No.: **29/119,427**

DESCRIPTION

(22) Filed: **Feb. 29, 2000**

(51) **LOC (7) Cl.** **09-07**

(52) **U.S. Cl.** **D9/443**

(58) **Field of Search** D9/434; D3/328;
383/12, 13, 15, 16, 22, 23, 24, 78, 81,
92

FIG. 1 is a perspective view of a bag closure with snap-open handle showing my new design, shown with the closure in an opened position;

FIG. 2 is a front elevational view with the closure in the closed position;

FIG. 3 is a rear elevational view of FIG. 2;

FIG. 4 is a left side elevation view of FIG. 2;

FIG. 5 is a right side elevational view of FIG. 2;

FIG. 6 is a top plan view of FIG. 2;

FIG. 7 is bottom plan view of FIG. 2; and,

FIG. 8 is an enlarged sectional view along line 8—8 of FIG. 2.

The bag portion is shown in broken lines for illustrative purposes only and forms no part of the claimed design.

(56) **References Cited**

U.S. PATENT DOCUMENTS

D. 242,764	*	12/1976	Kamins	D6/434
D. 255,332	*	6/1980	DuCorday	D9/434
D. 412,116	*	7/1999	DuCorday	D9/443
D. 415,683	*	10/1999	DuCorday	D9/443
D. 430,030	*	8/2000	DuCorday	D9/443
D. 430,490	*	9/2000	DuCorday	D9/443
3,452,922	*	7/1969	Hart	D9/305 X

* cited by examiner

1 Claim, 3 Drawing Sheets

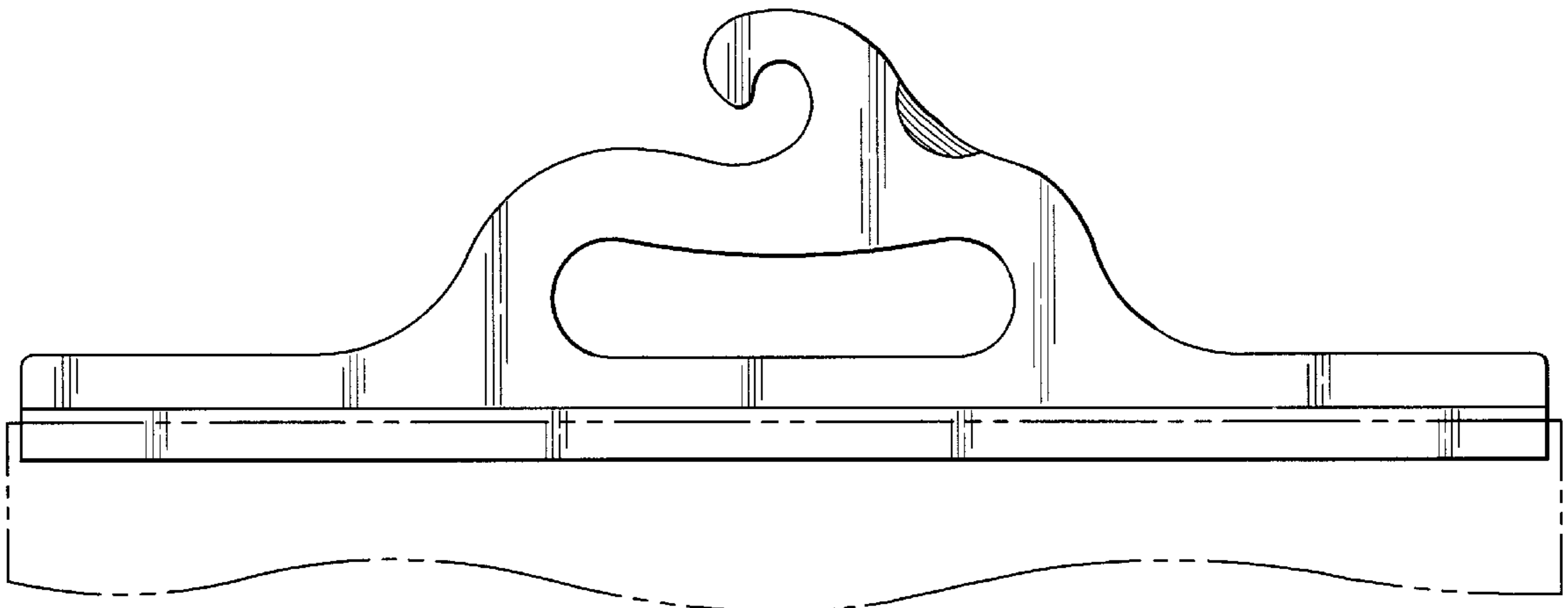
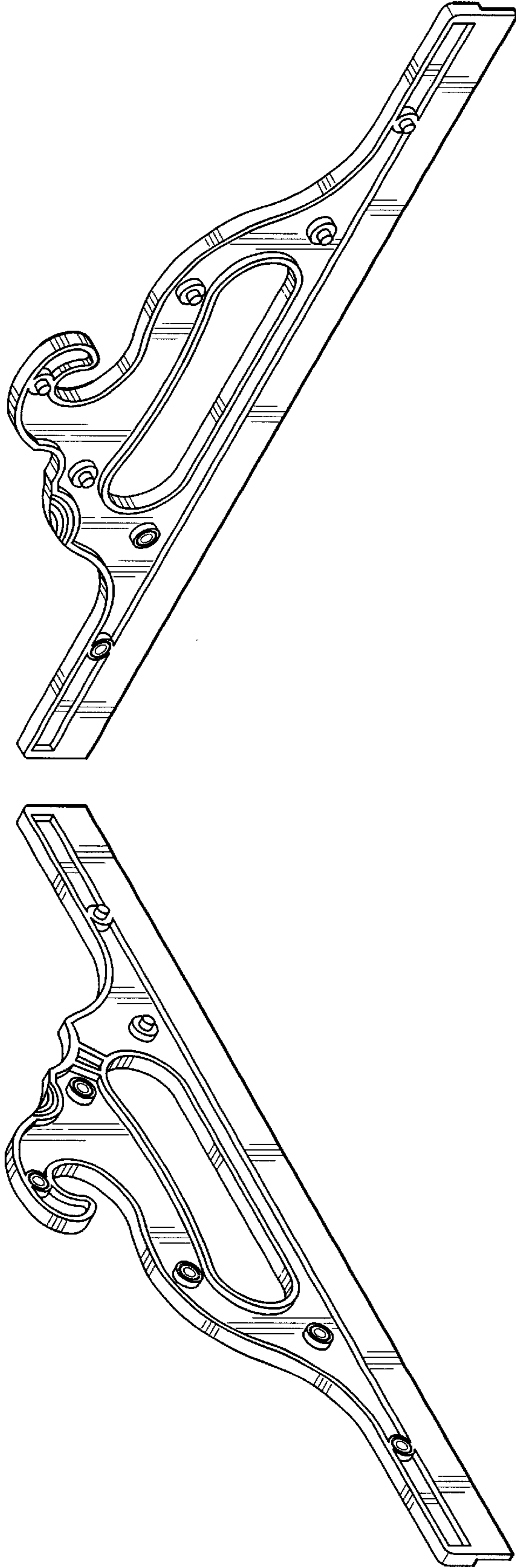

Fig. 1



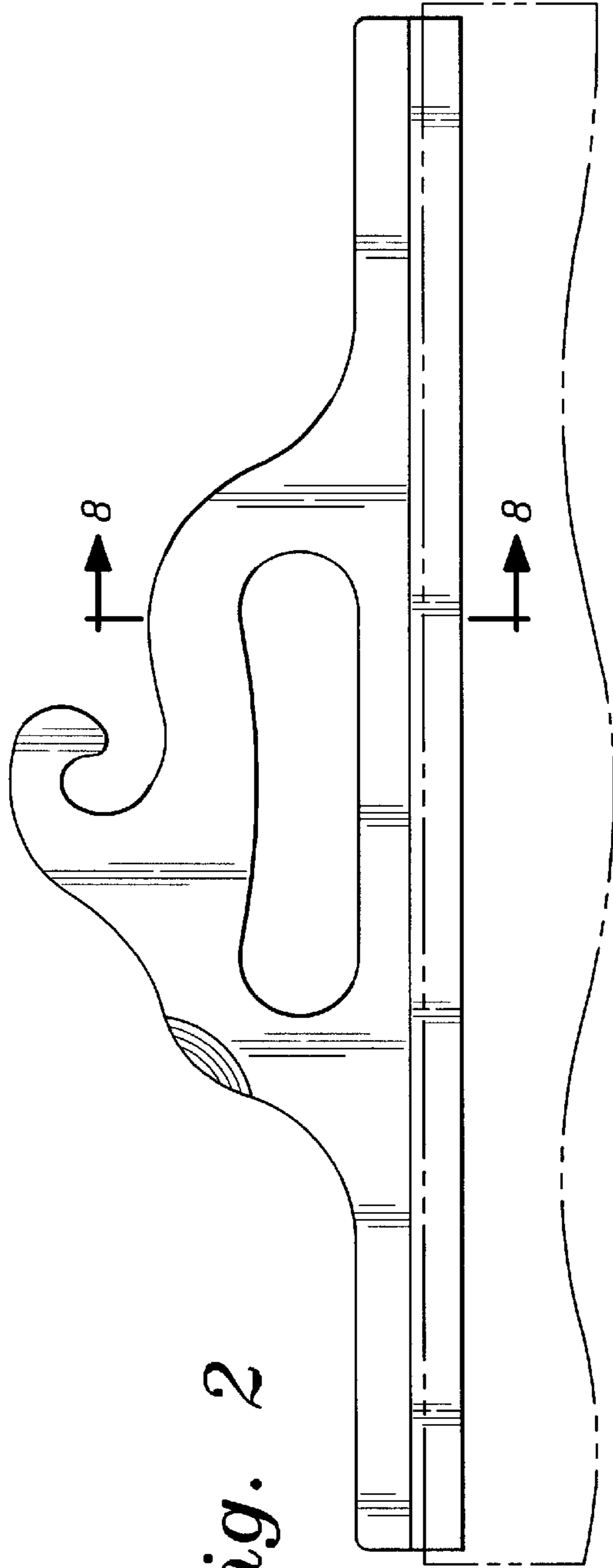

Fig. 2

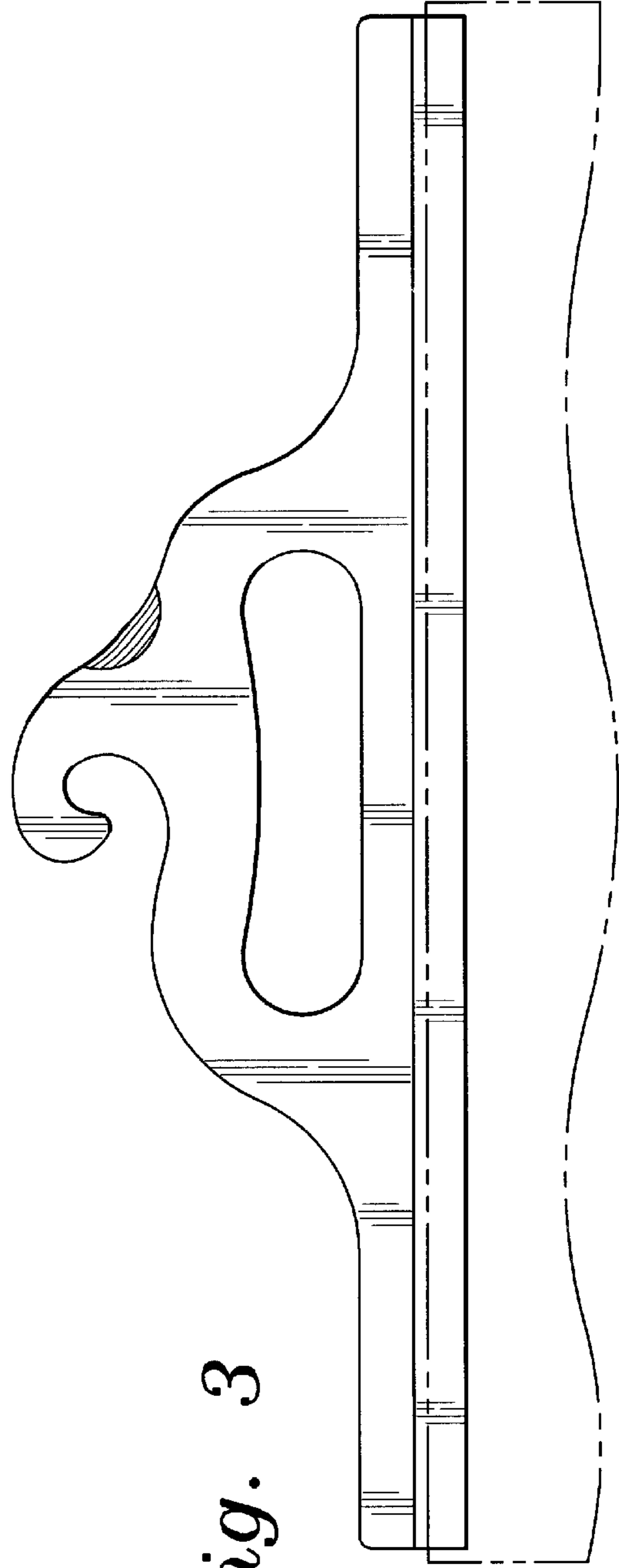

Fig. 3

Fig. 6



Fig. 7

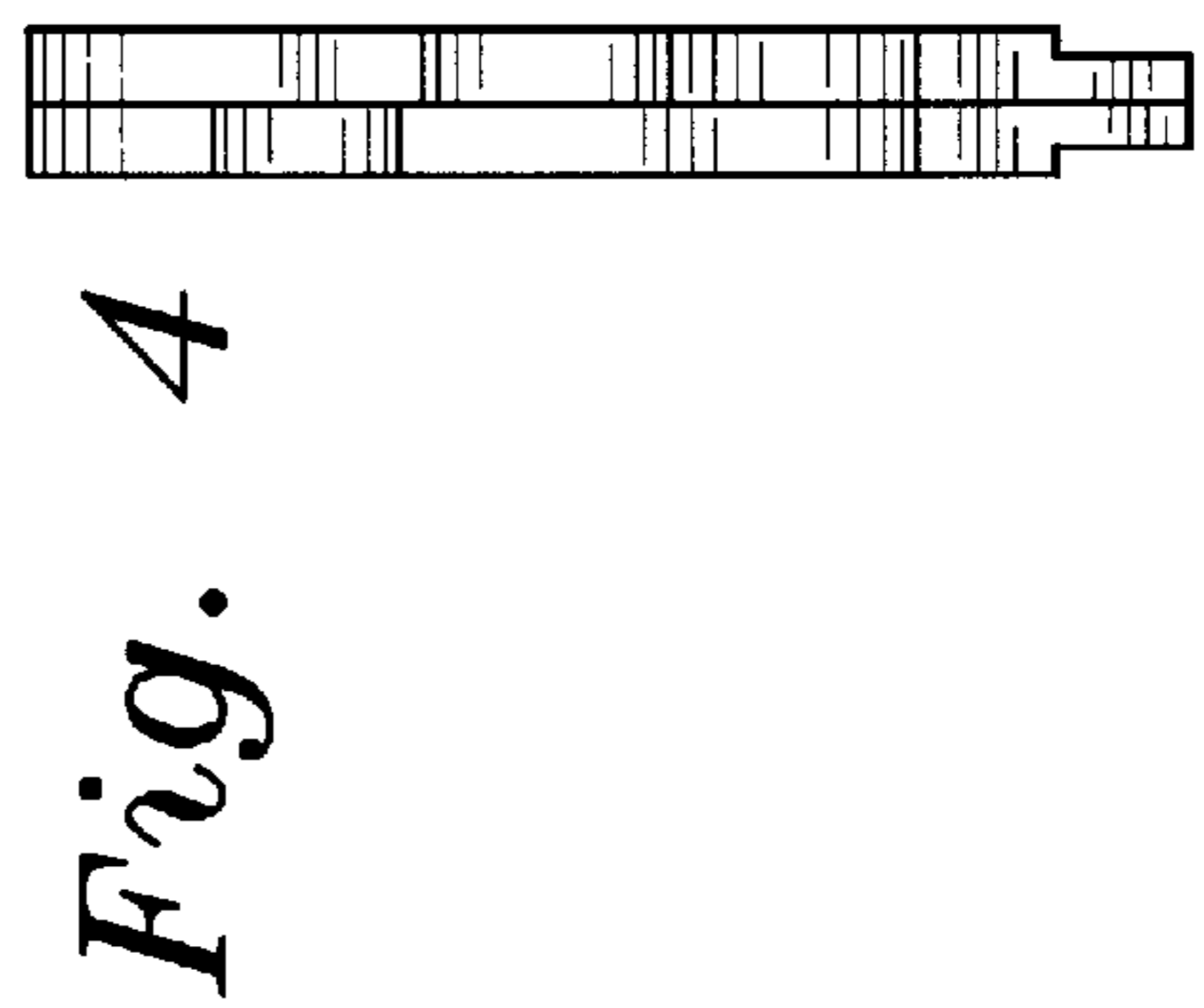
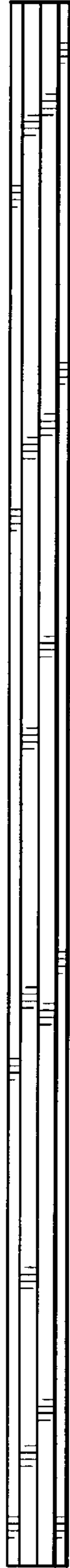

Fig. 4

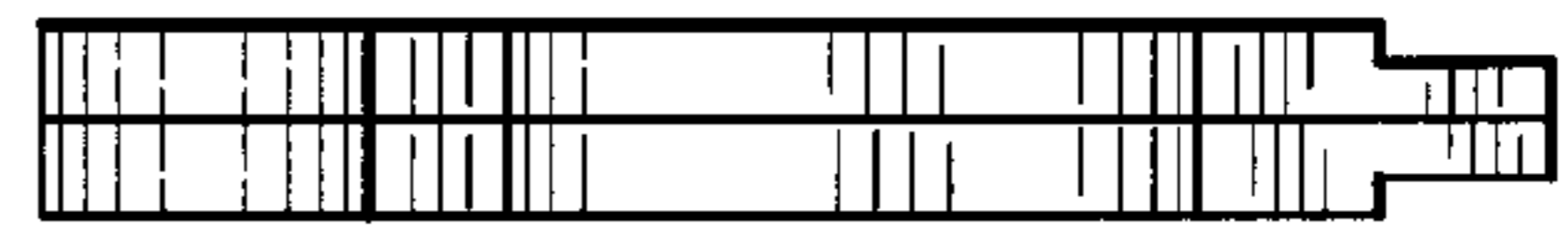

Fig. 5

Fig. 8

