



US00D447412B1

(12) **United States Design Patent**  
**Durdon**

(10) **Patent No.:** **US D447,412 S**

(45) **Date of Patent:** **\*\* Sep. 4, 2001**

(54) **DISPOSABLE CUP LID**

(75) Inventor: **Terrance N. Durdon, Guelph (CA)**

(73) Assignee: **Amhil Enterprises, Mississauga (CA)**

(\*\*) Term: **14 Years**

(21) Appl. No.: **29/134,433**

(22) Filed: **Dec. 22, 2000**

(51) **LOC (7) Cl.** ..... **09-07**

(52) **U.S. Cl.** ..... **D9/438; D9/447**

(58) **Field of Search** ..... D9/435, 438, 447,  
D9/454; D7/510, 511, 629, 392, 392.1;  
215/254; 220/270, 271, 711, 712, 713,  
714

(56) **References Cited**

**U.S. PATENT DOCUMENTS**

D. 259,705	*	6/1981	Bagwell	.....	D9/454
D. 267,633	*	1/1983	Christian	.....	D9/438
D. 274,502	*	7/1984	Little	.....	D9/438
D. 402,556	*	12/1998	Frye	.....	D9/447
D. 418,363	*	1/2000	Barnes et al.	.....	D7/392
4,202,459	*	5/1980	DeParales et al.	.....	220/712
5,392,949	*	2/1995	McKenna	.....	220/712
5,699,927	*	12/1997	Lane et al.	.....	220/254
5,839,601	*	11/1998	Melle	.....	220/712
5,947,323	*	9/1999	Freek et al.	.....	220/709
6,089,397	*	7/2000	Van Melle	.....	220/270

\* cited by examiner

*Primary Examiner*—Cathron C. Brooks

(74) *Attorney, Agent, or Firm*—Marks & Clerk

(57) **CLAIM**

The ornamental design for a disposable cup lid, as shown and described.

**DESCRIPTION**

FIG. 1 is a perspective view of disposable cup lid in keeping with the present invention;

FIG. 2 is a reduced front view of the disposable cup lid of FIG. 1;

FIG. 3 is a reduced back view of the disposable cup lid of FIG. 1;

FIG. 4 is a reduced right side view (as seen in FIG. 1) of the disposable cup lid of FIG. 1;

FIG. 5 is a reduced left side view (as seen in FIG. 1) of the disposable cup lid of FIG. 1;

FIG. 6 is a reduced top view of the disposable cup lid of FIG. 1;

FIG. 7 is a reduced bottom view of the disposable cup lid of FIG. 1;

FIG. 8 is a perspective view of a second embodiment of disposable cup lid in keeping with the present invention;

FIG. 9 is a reduced front view of the disposable cup lid of FIG. 8;

FIG. 10 is a reduced back view of the disposable cup lid of FIG. 8;

FIG. 11 is a reduced right side view (as seen in FIG. 8) of the disposable cup lid of FIG. 8;

FIG. 12 is a reduced left side view (as seen in FIG. 8) of the disposable cup lid of FIG. 8;

FIG. 13 is a reduced top view of the disposable cup lid of FIG. 8; and,

FIG. 14 is a reduced bottom view of the disposable cup lid of FIG. 8.

**1 Claim, 6 Drawing Sheets**

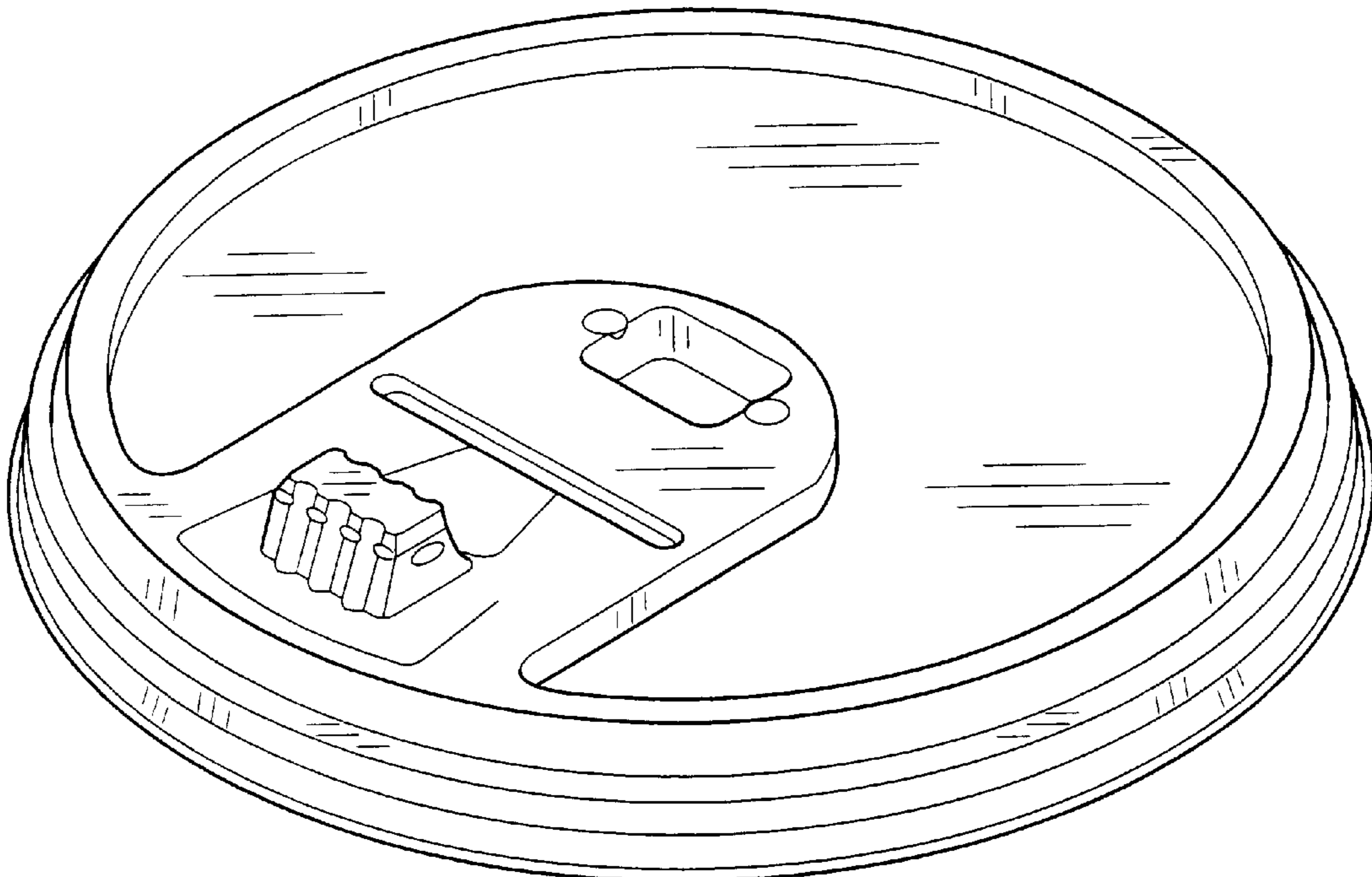

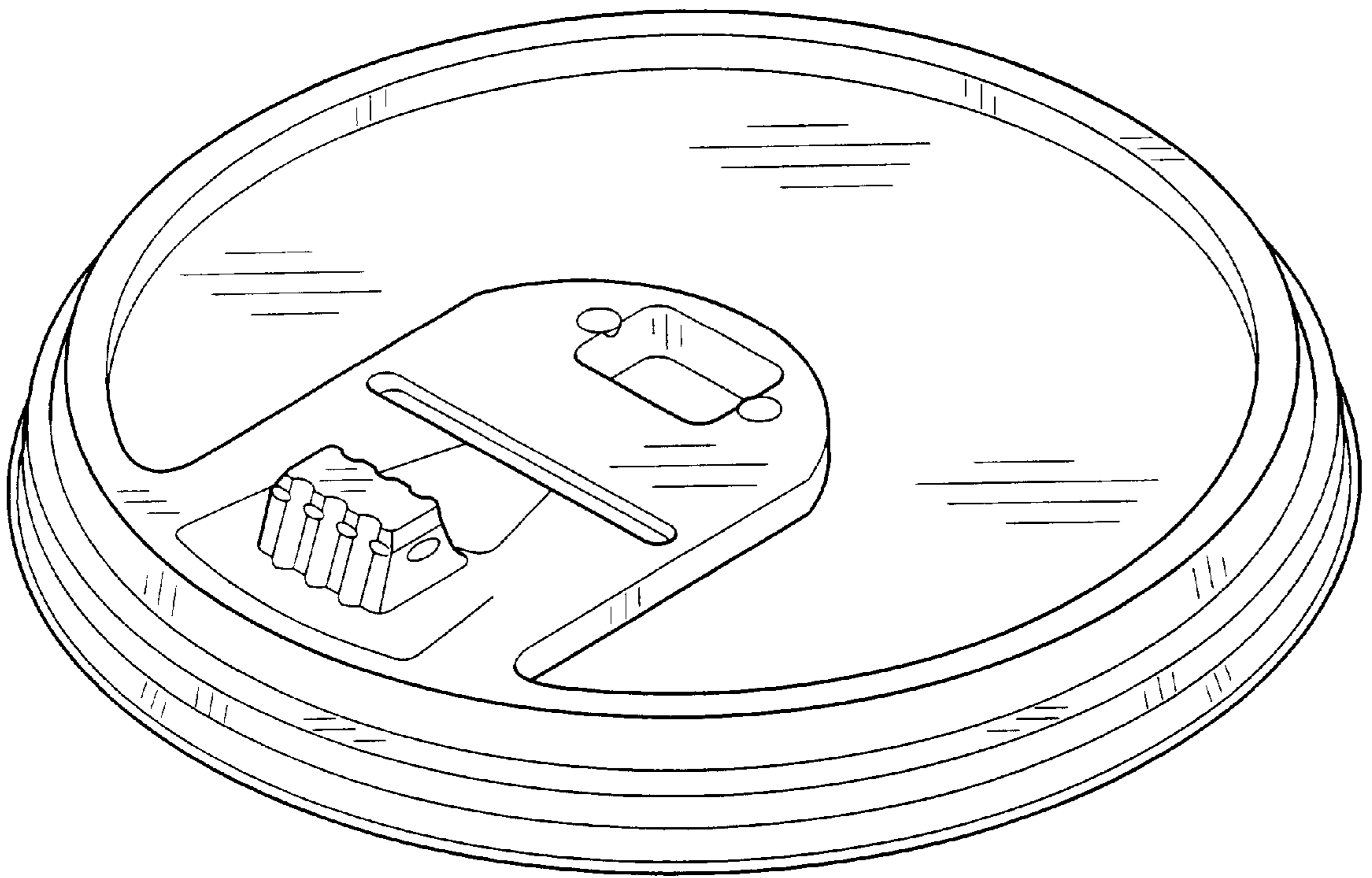

FIG. 1

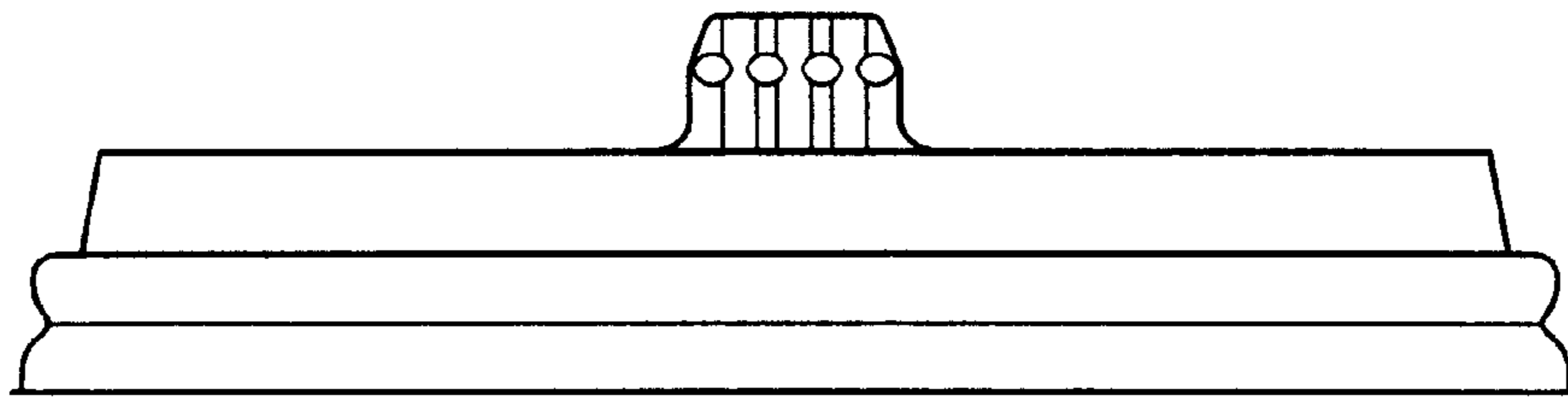

FIG. 2

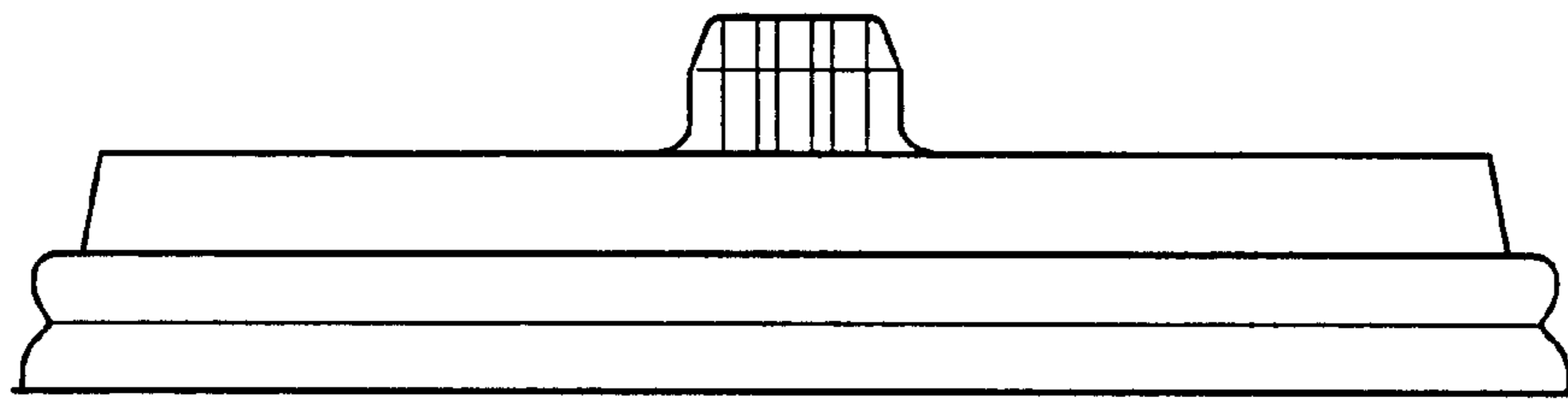

FIG. 3

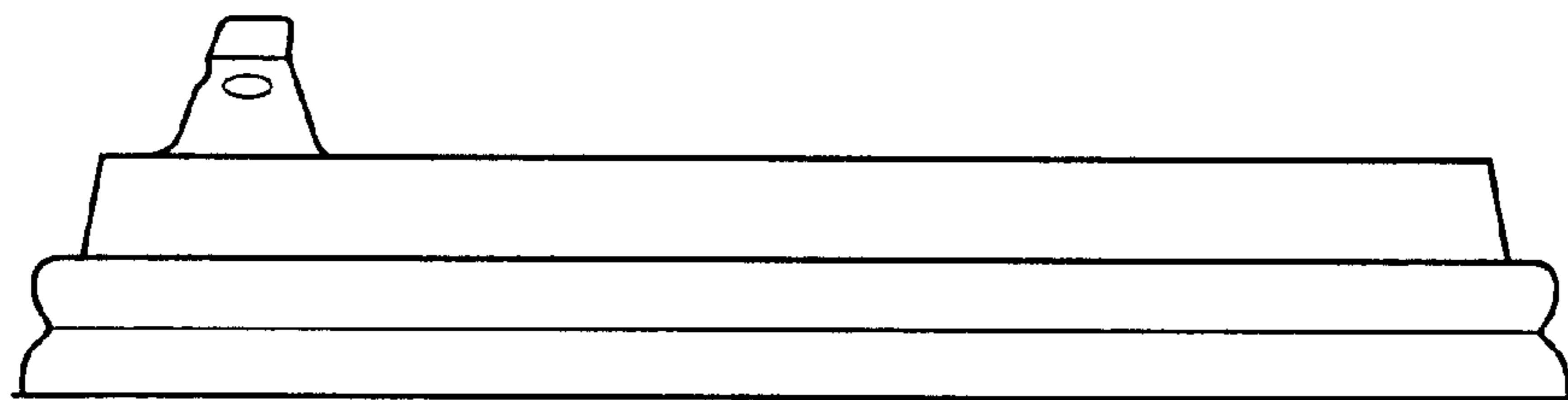

FIG. 4

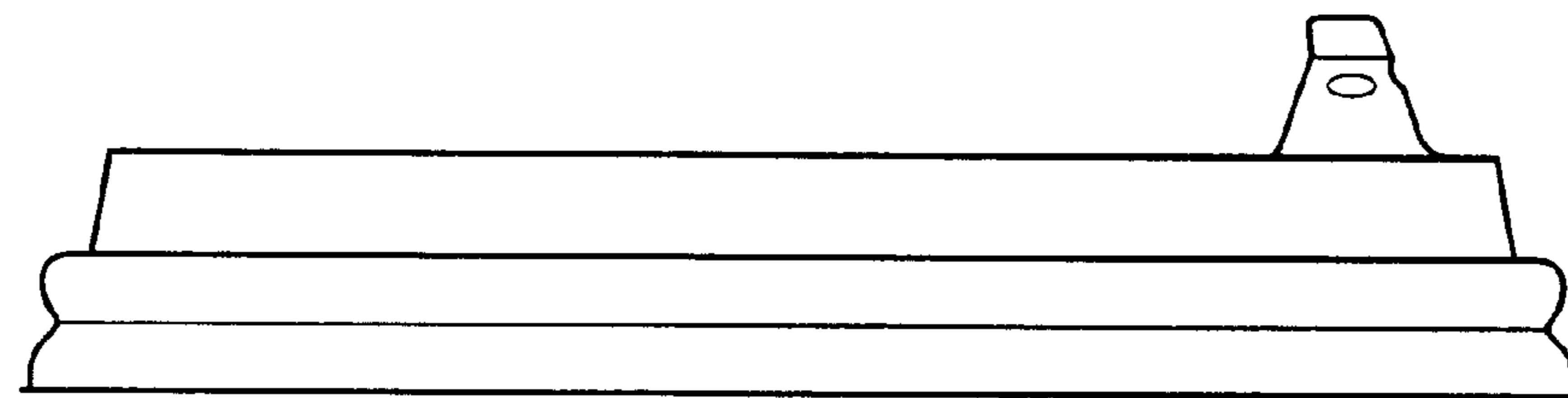

FIG. 5

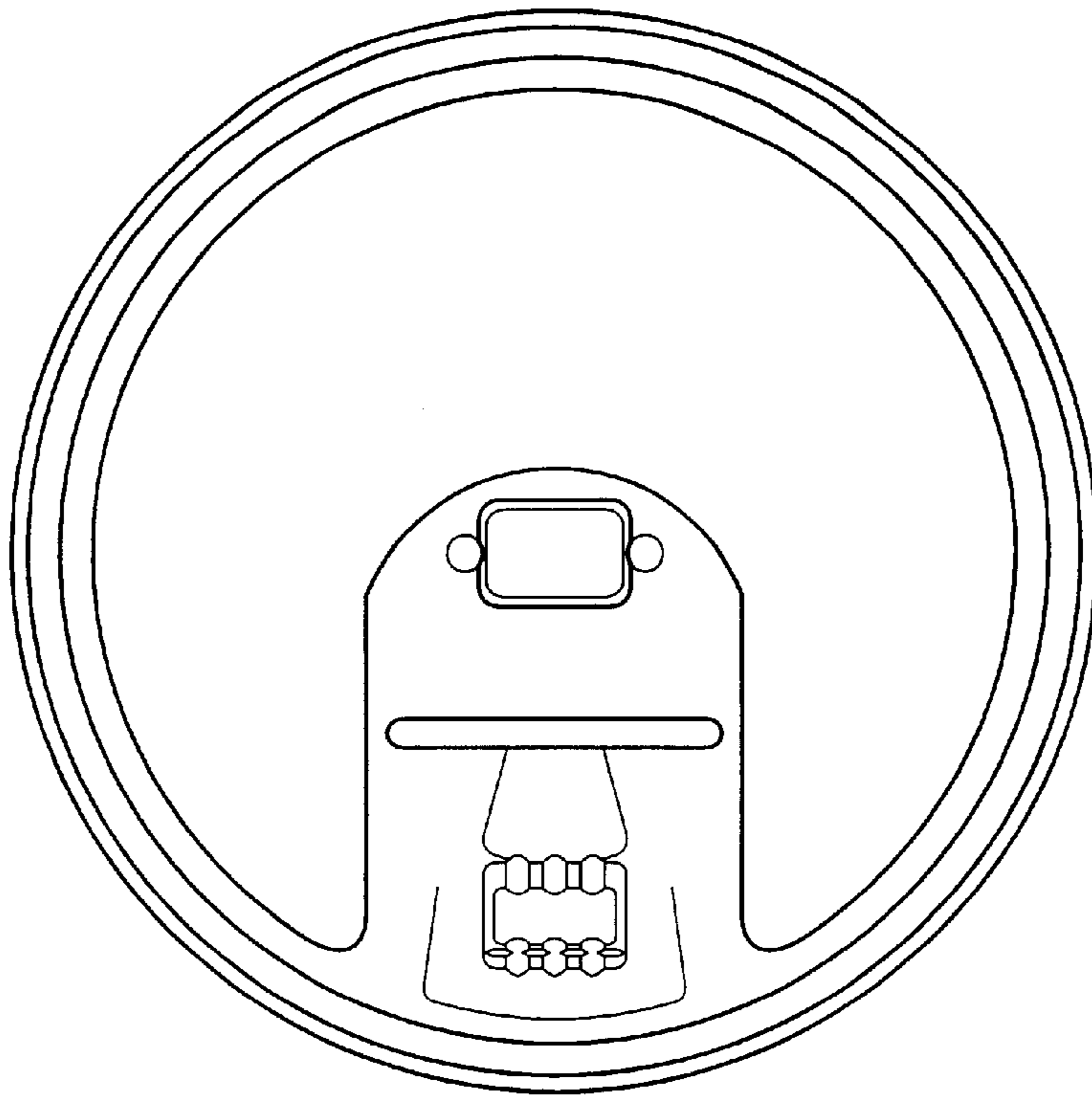

FIG. 6

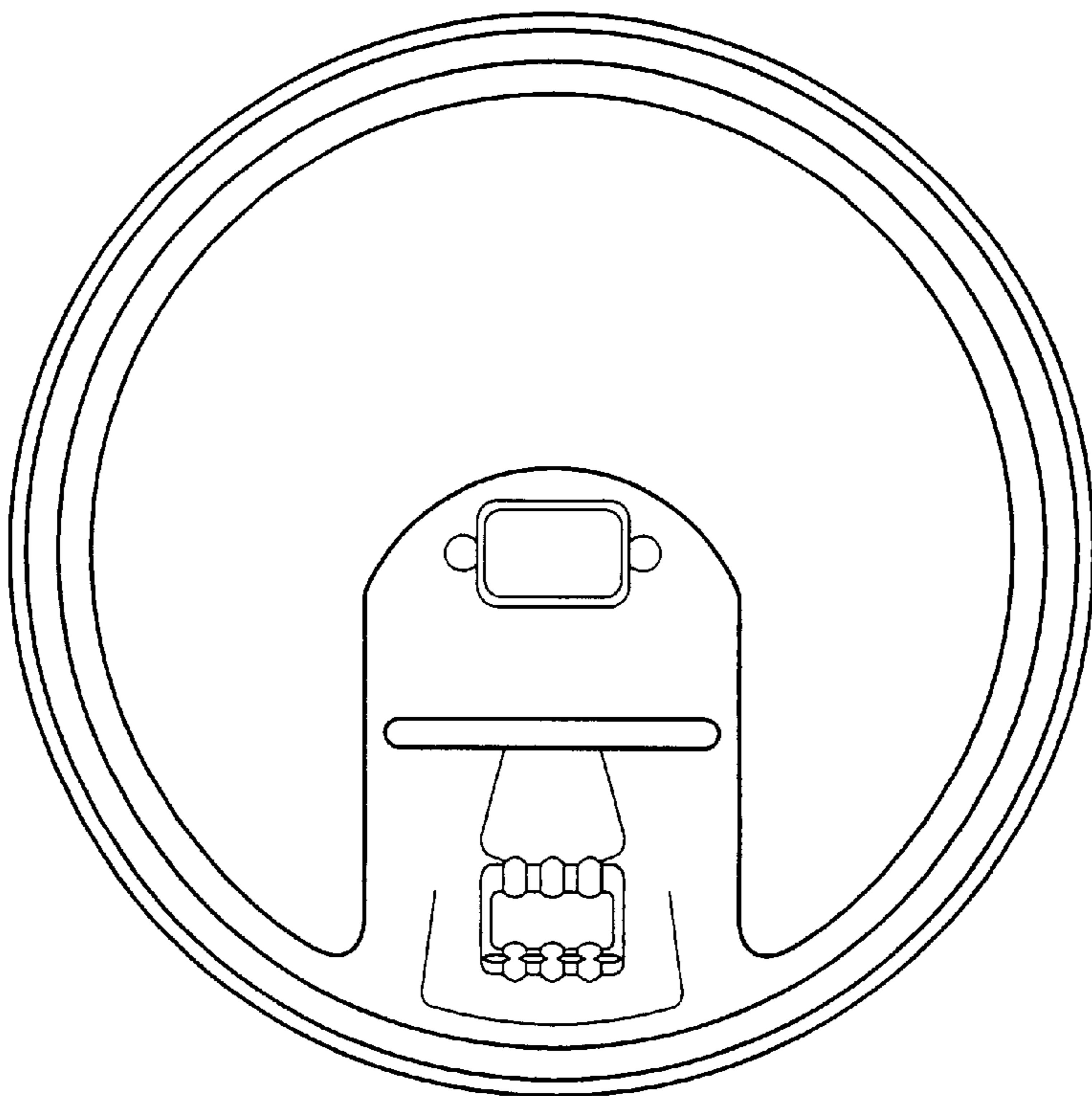

FIG. 7

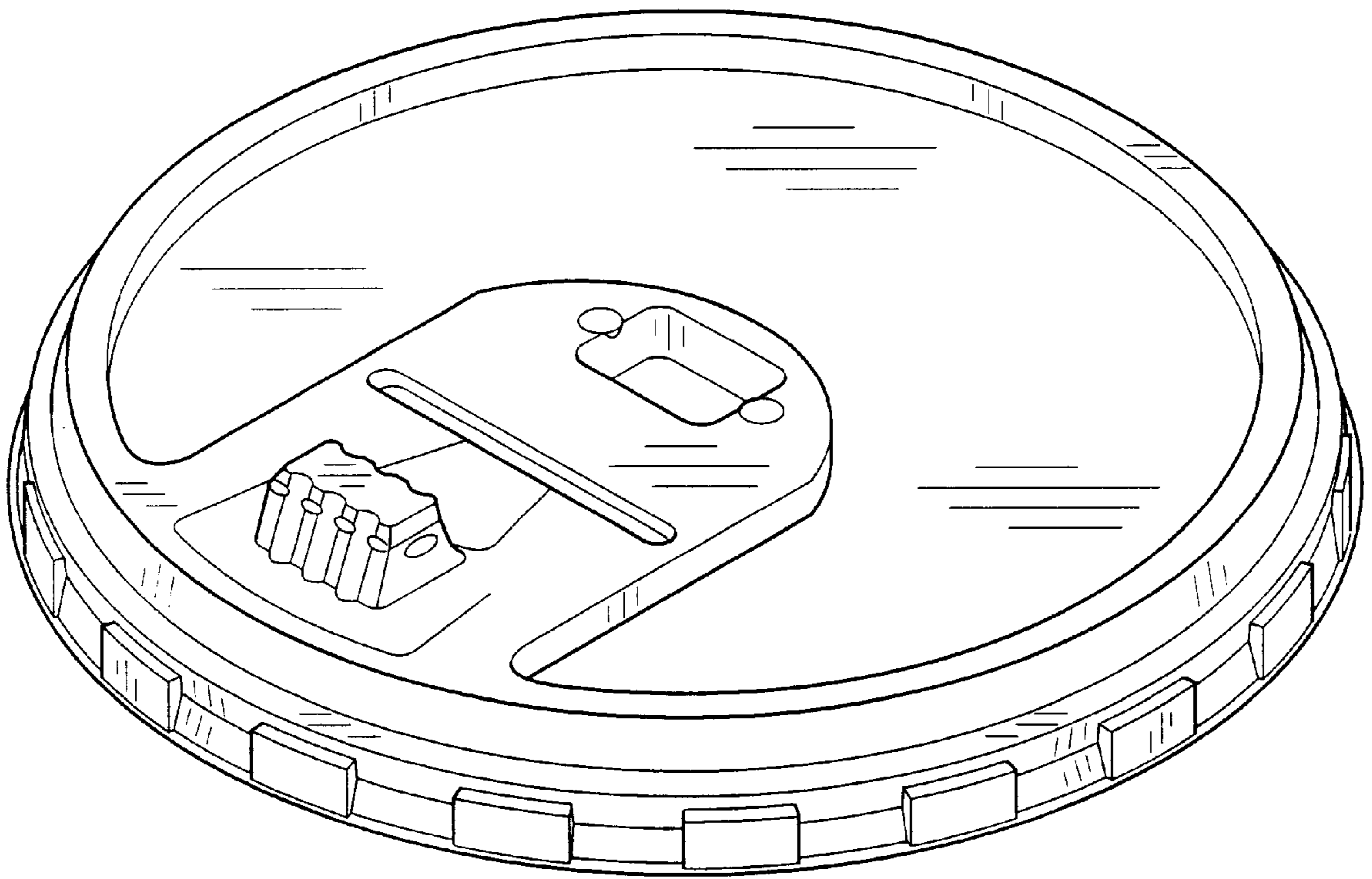

FIG. 8

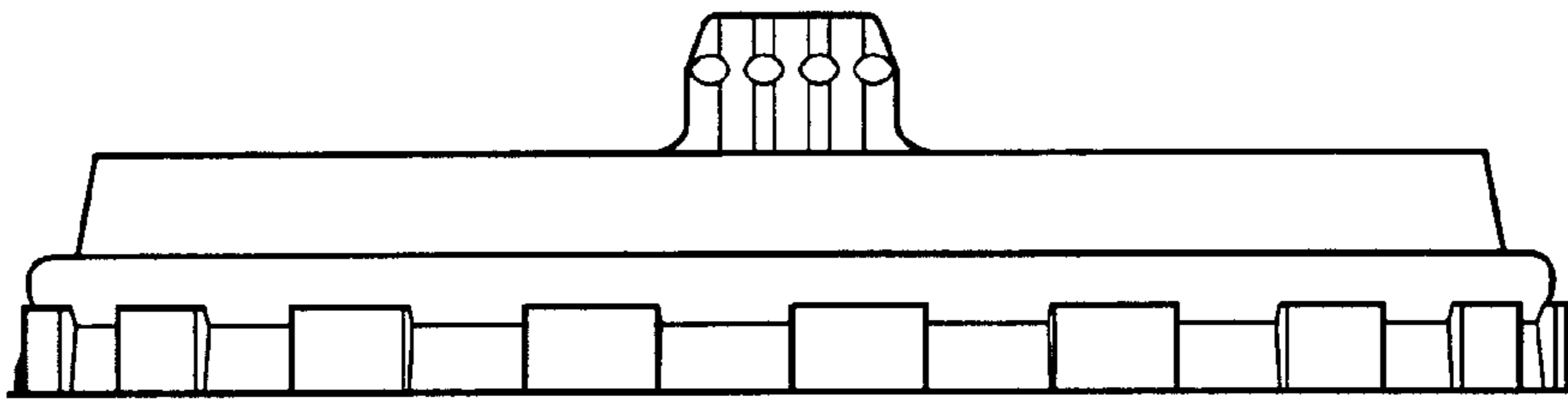

FIG. 9

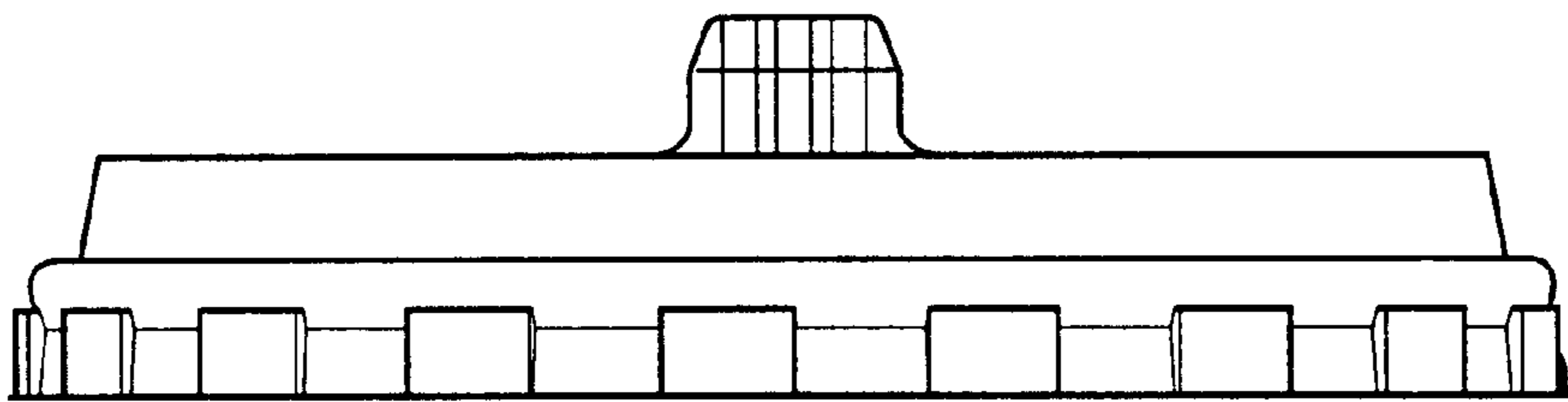

FIG. 10

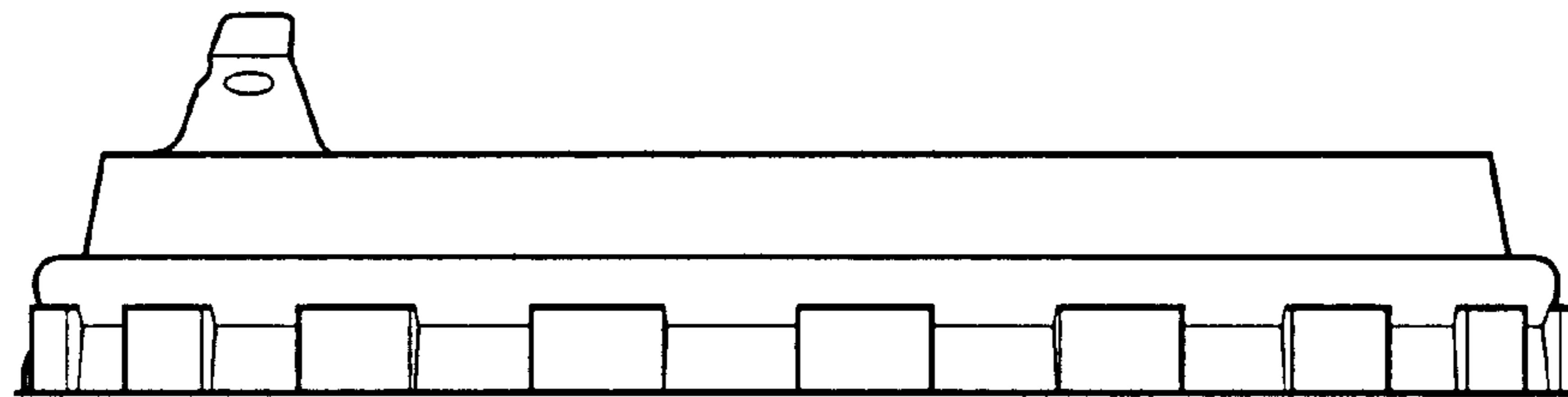

FIG. 11

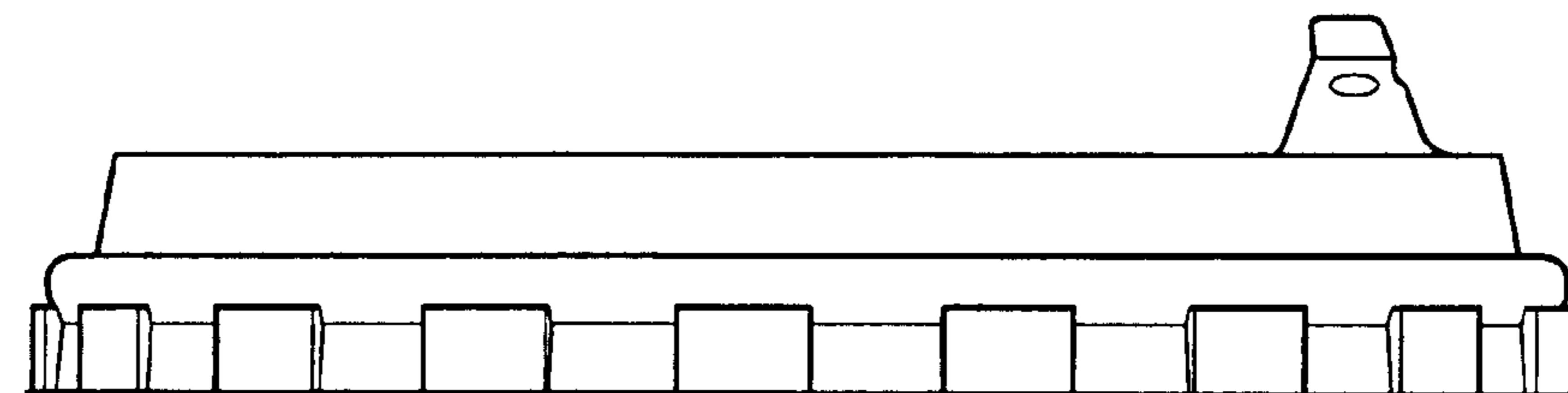

FIG. 12

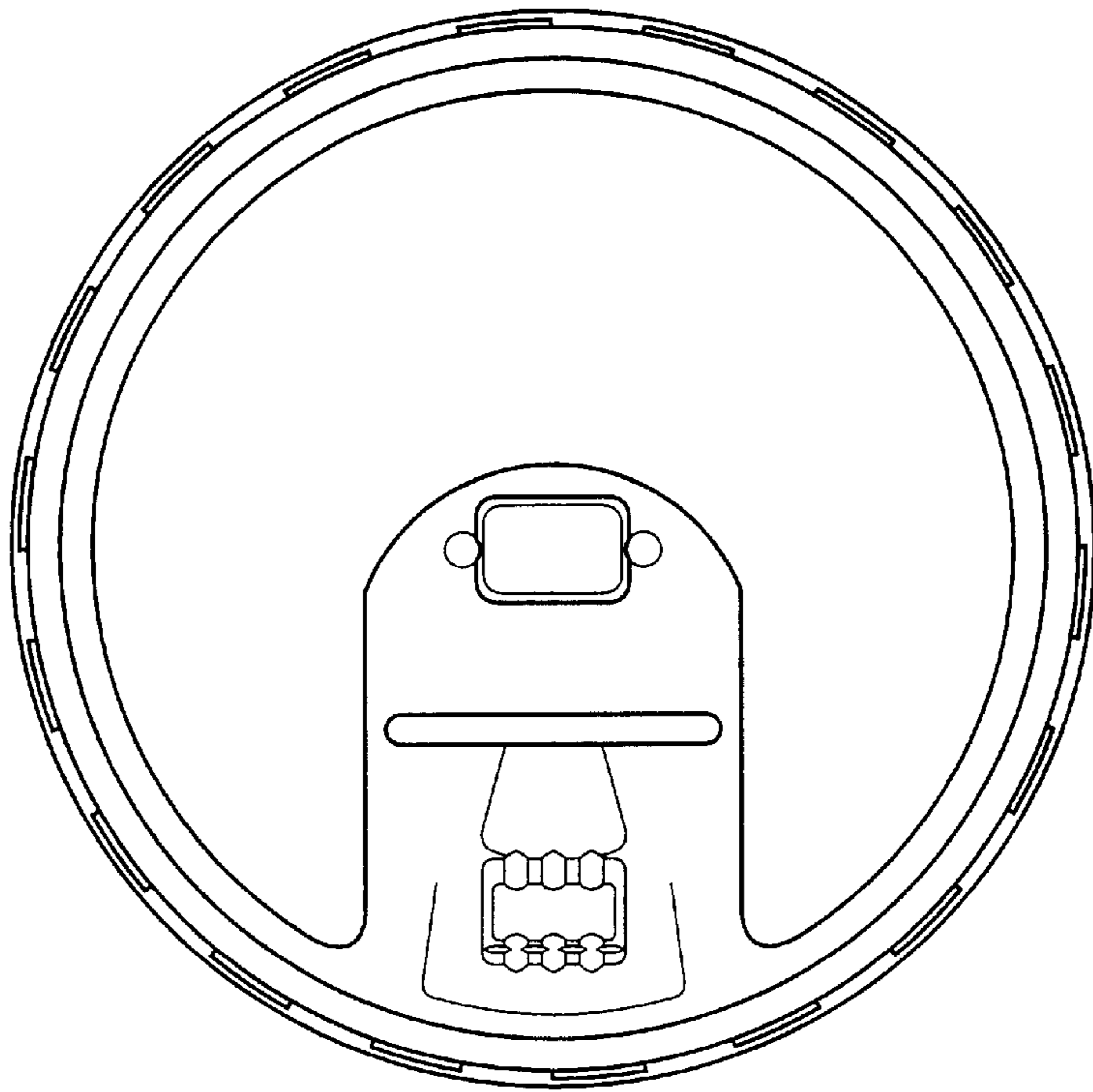

FIG. 13

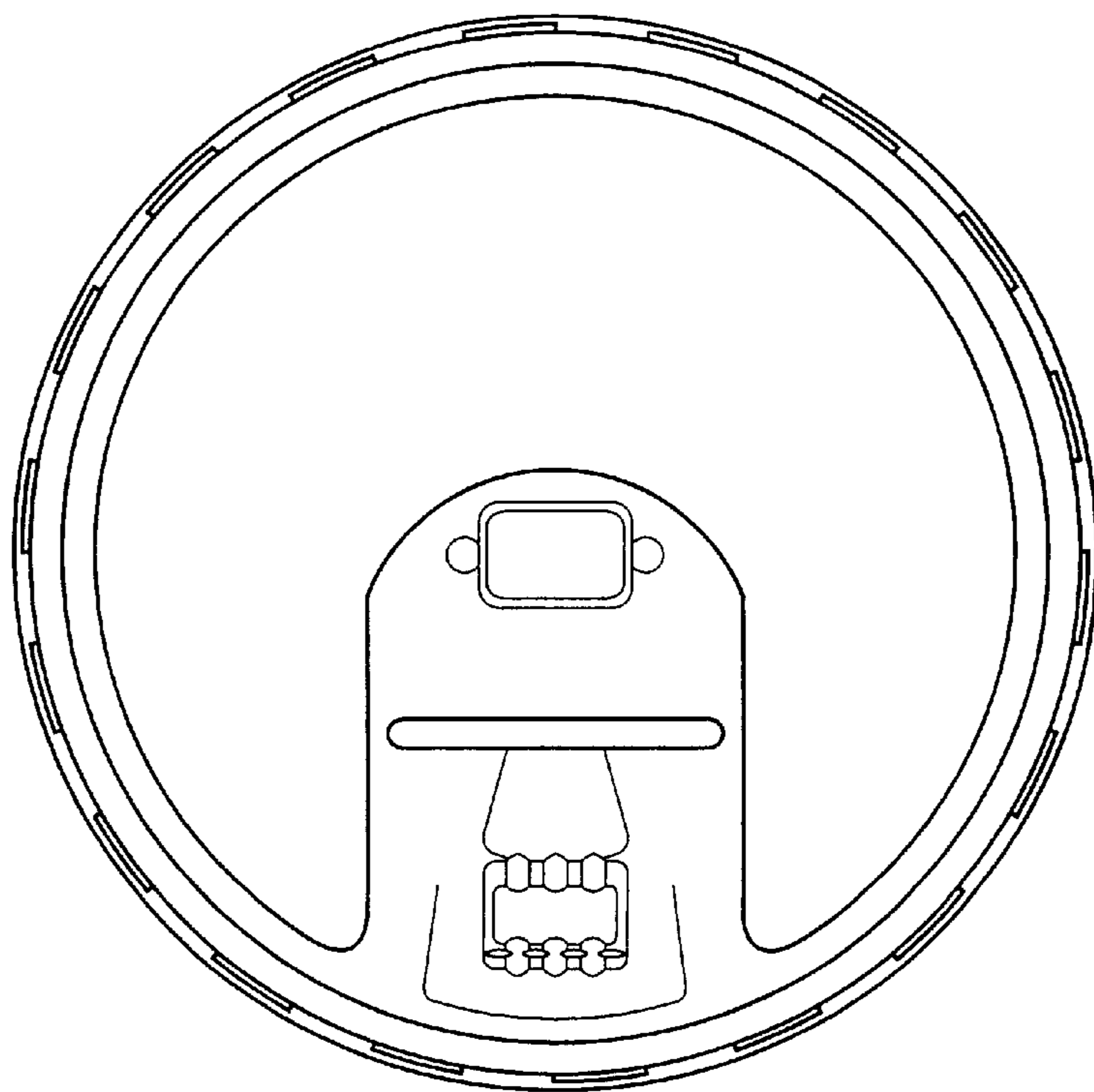

FIG. 14