



US00D447379B1

(12) **United States Design Patent**
DiNunzio et al.

(10) **Patent No.:** **US D447,379 S**

(45) **Date of Patent:** **** Sep. 4, 2001**

(54) **MIXING APPLIANCE**

(76) Inventors: **David DiNunzio**, 9314 Lakeshore Blvd., Mentor, OH (US) 44060;
Timothy E. Lint, 2825 Augustine Dr., Parma, OH (US) 44134

(**) Term: **14 Years**

(21) Appl. No.: **29/086,046**

(22) Filed: **Apr. 3, 1998**
(Under 37 CFR 1.47)

(51) **LOC (7) Cl.** **31-00**

(52) **U.S. Cl.** **D7/376; D7/317**

(58) **Field of Search** D7/376-378, 384, D7/386, 312, 318; 99/287, 288, 509, 510, 511; 366/64, 65, 197, 199, 241

(56) **References Cited**

U.S. PATENT DOCUMENTS

D. 367,201 * 2/1996 Joergensen D7/305

D. 367,394 * 2/1996 Wai D7/305
D. 416,163 * 11/1999 Doritty et al. D7/319
D. 427,478 * 7/2000 Littmann et al. D7/318

* cited by examiner

Primary Examiner—Caron D. Veynar

(74) *Attorney, Agent, or Firm*—Kramer, Levin, Naftalis & Frankel LLP

(57) **CLAIM**

The ornamental design for a mixing appliance, as shown and described.

DESCRIPTION

FIG. 1 is a front elevation view of the mixing appliance showing our new design;
FIG. 2 is a left side elevation view thereof;
FIG. 3 is a right side elevation view thereof;
FIG. 4 is a rear elevation view thereof;
FIG. 5 is a top plan view thereof; and,
FIG. 6 is a bottom plan view thereof.

1 Claim, 6 Drawing Sheets

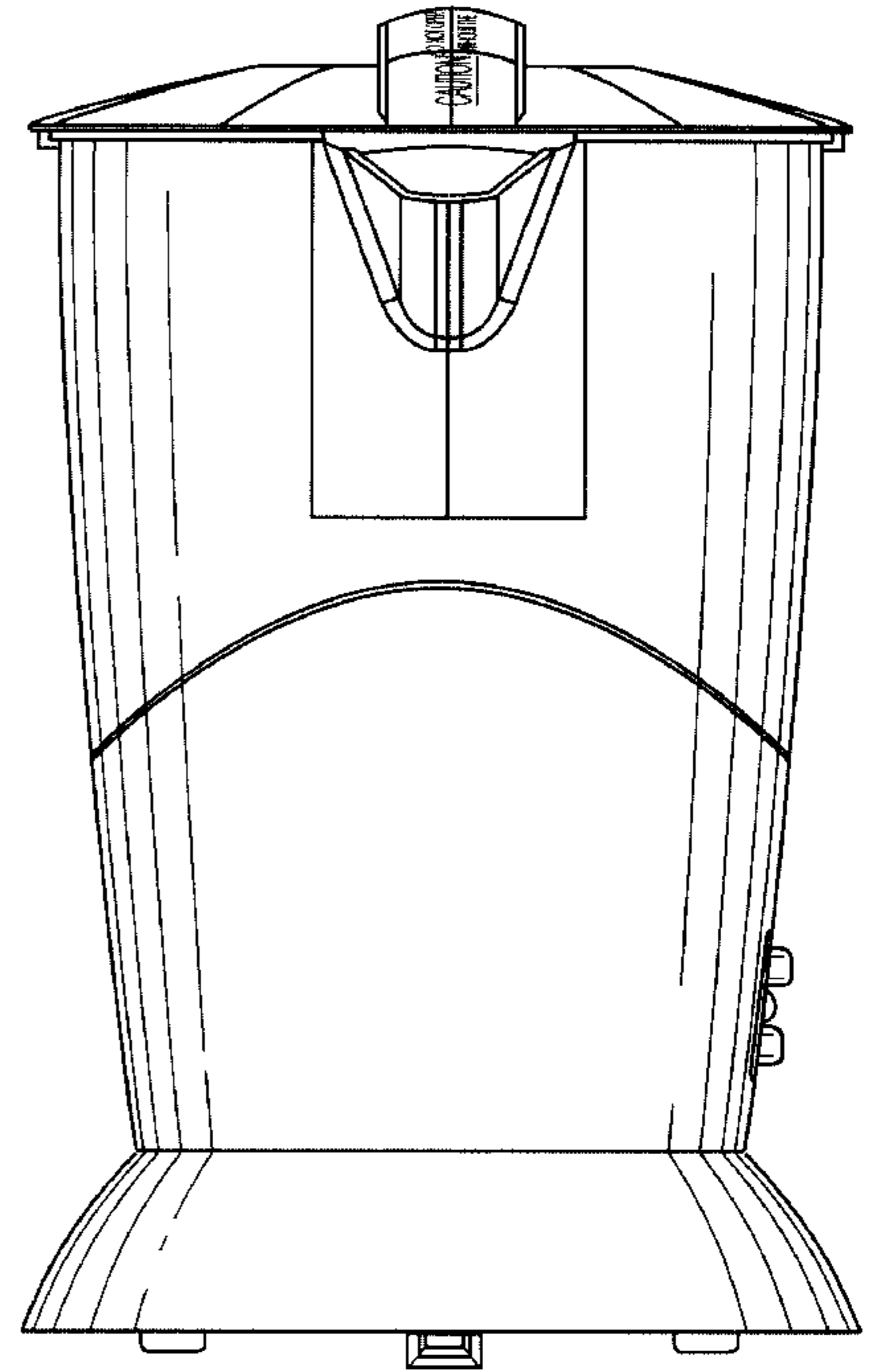
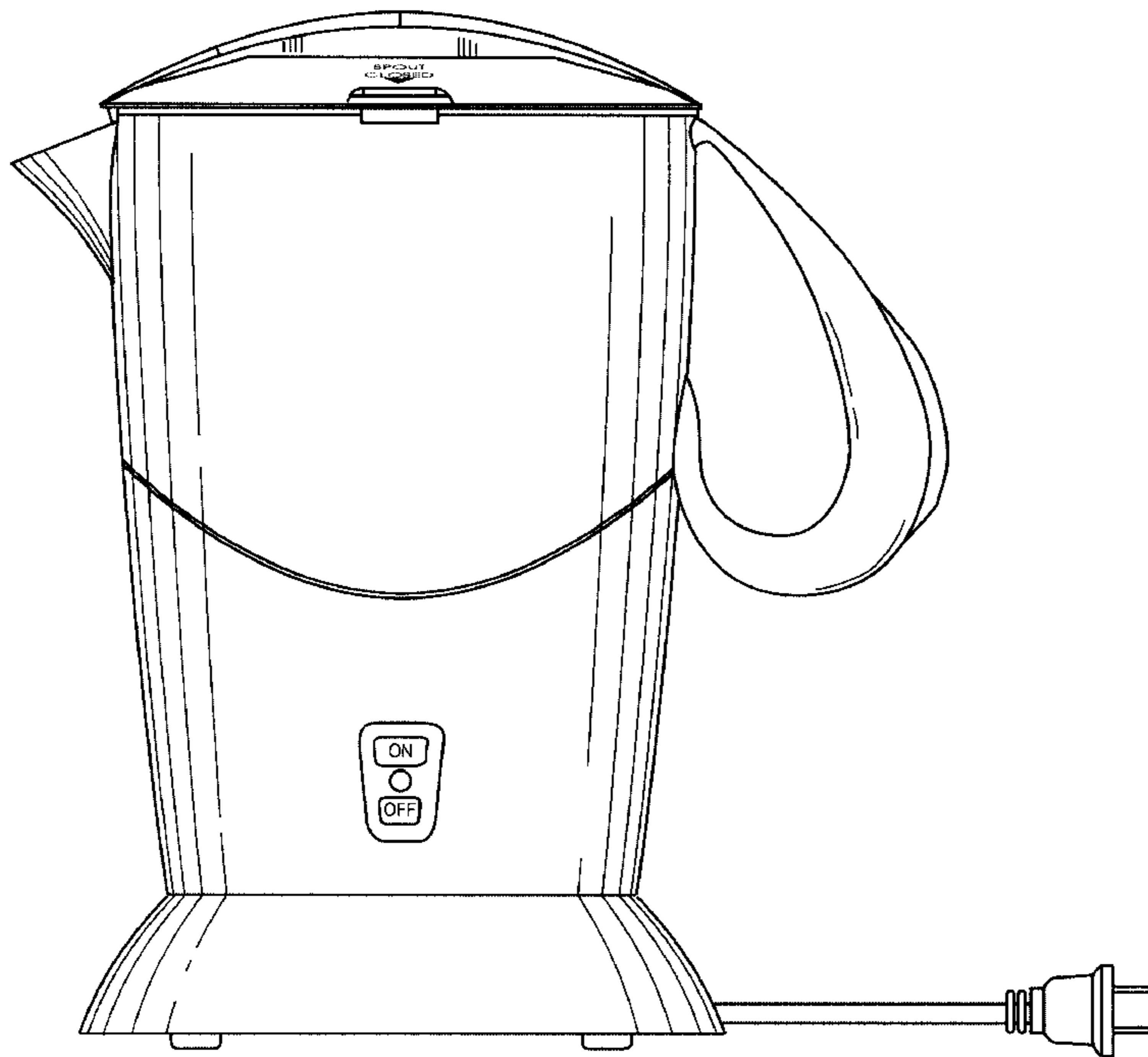

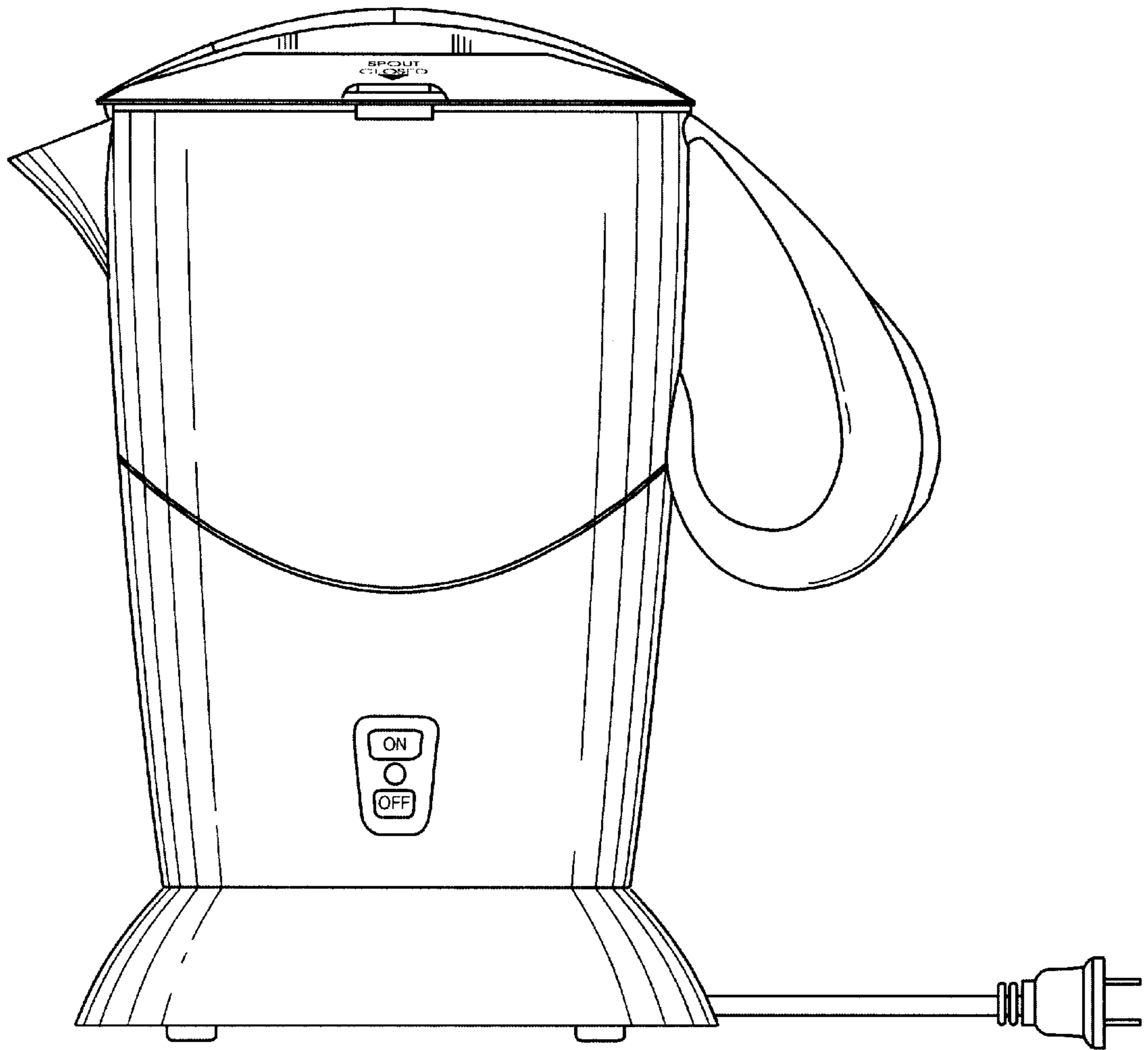

FIG. 1

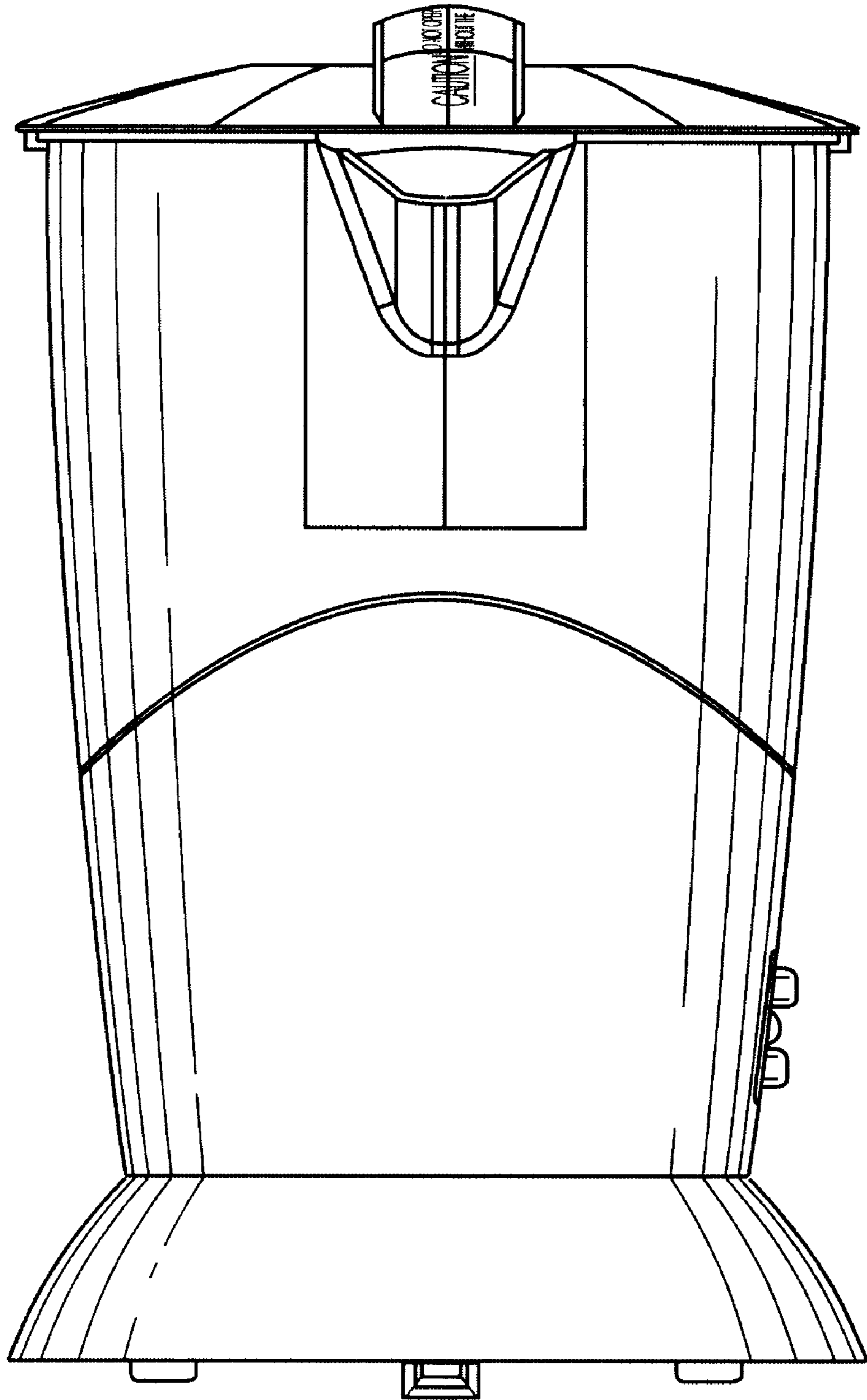

FIG. 2

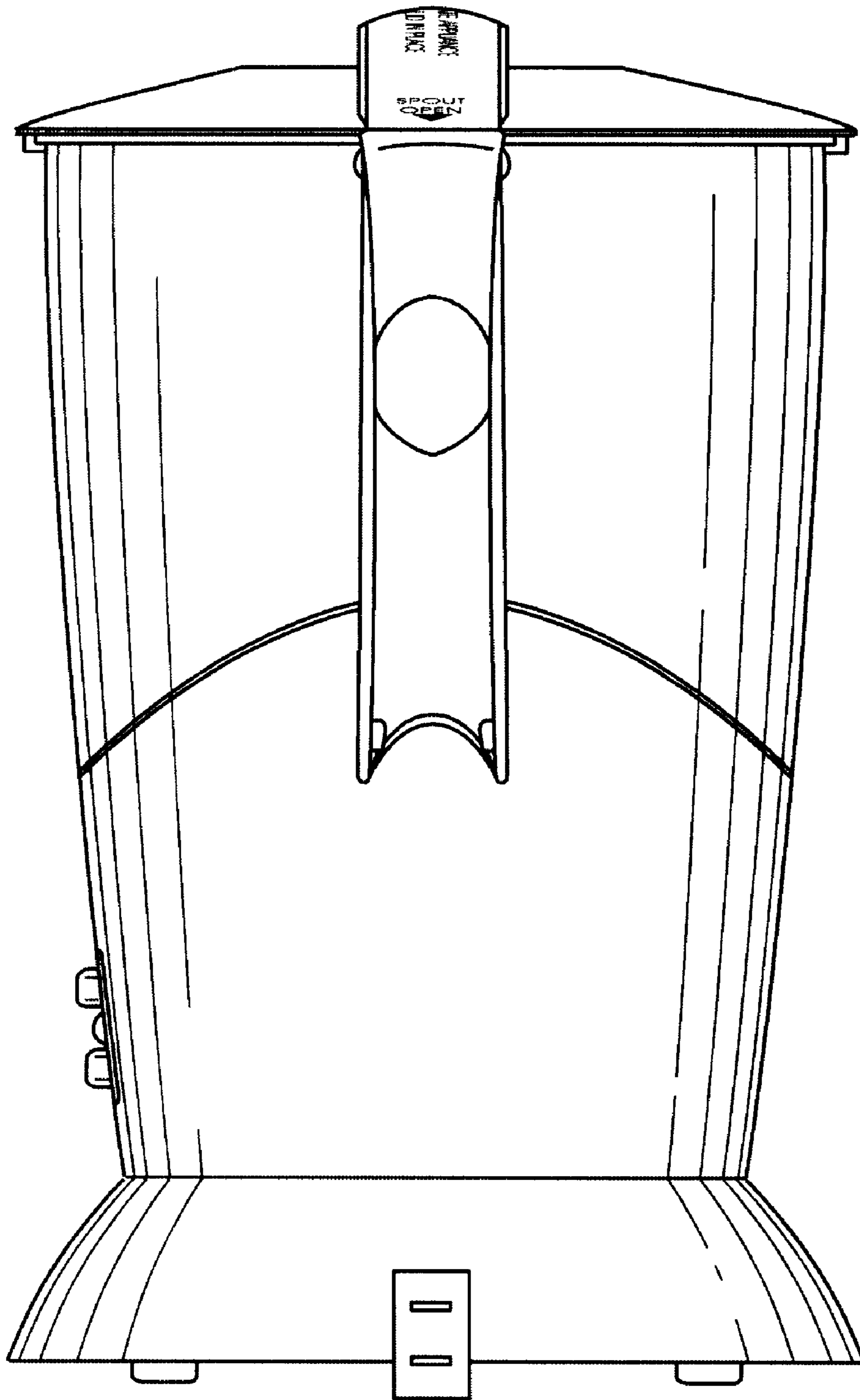

FIG. 3

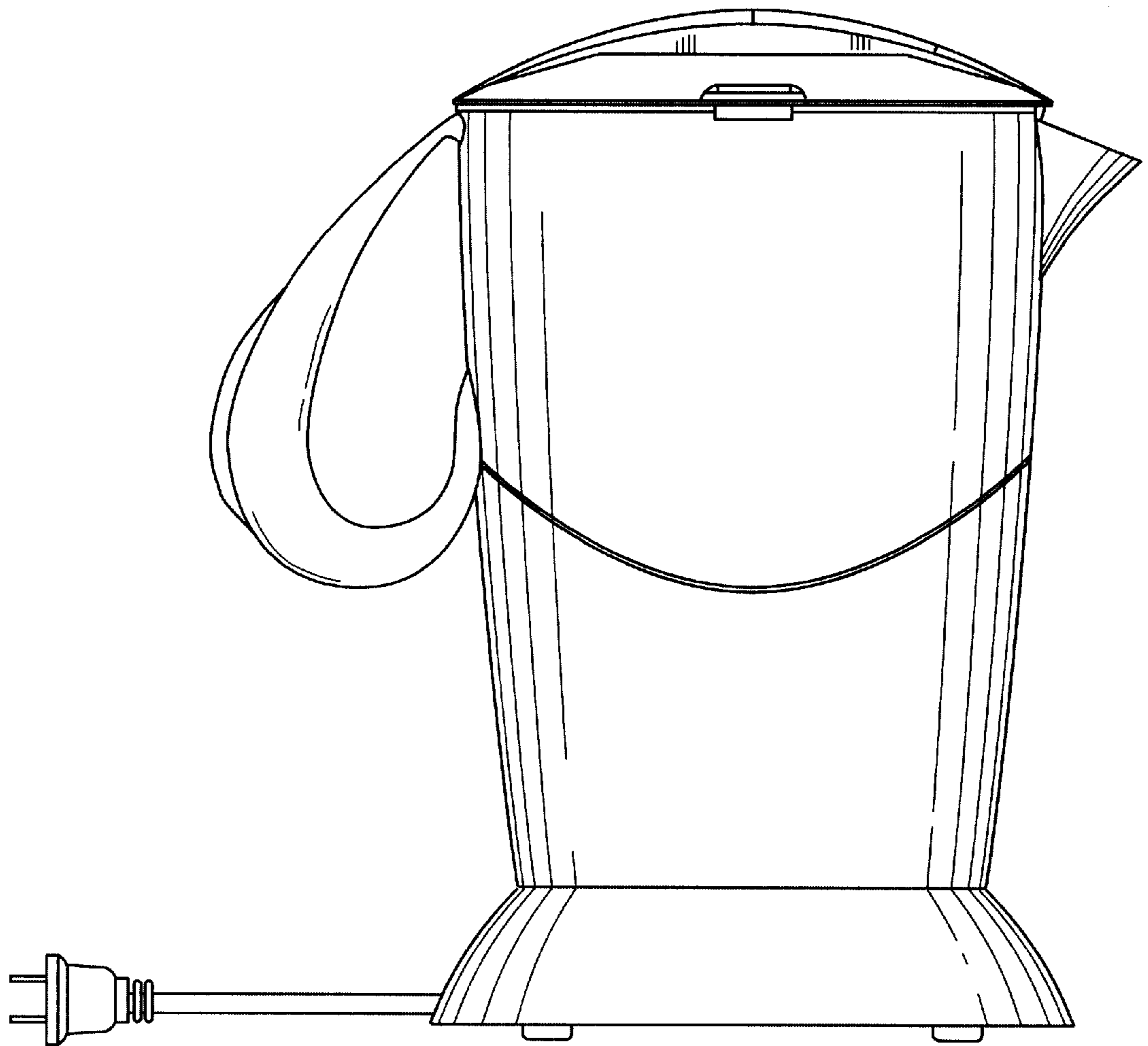

FIG. 4

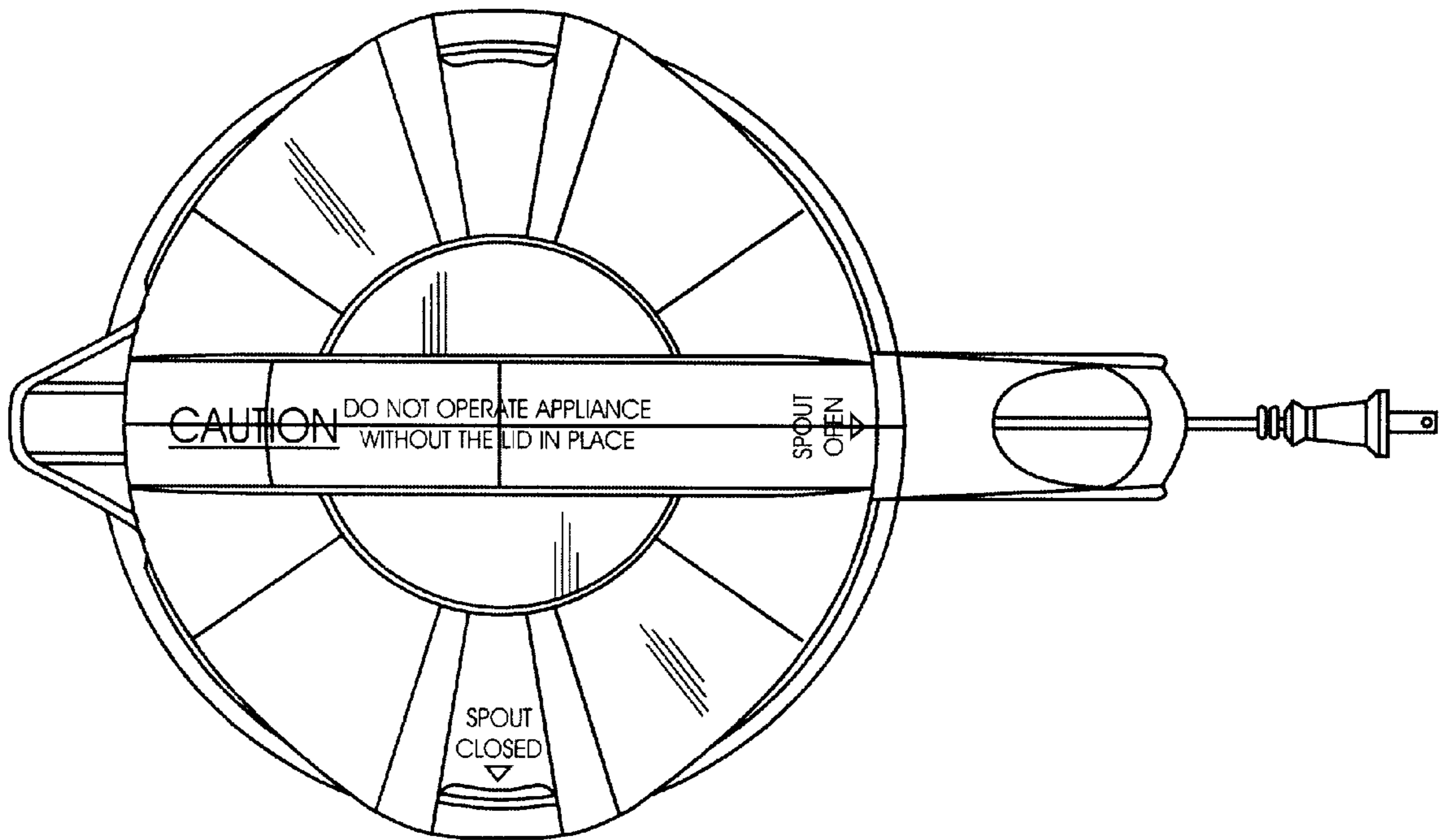

FIG. 5

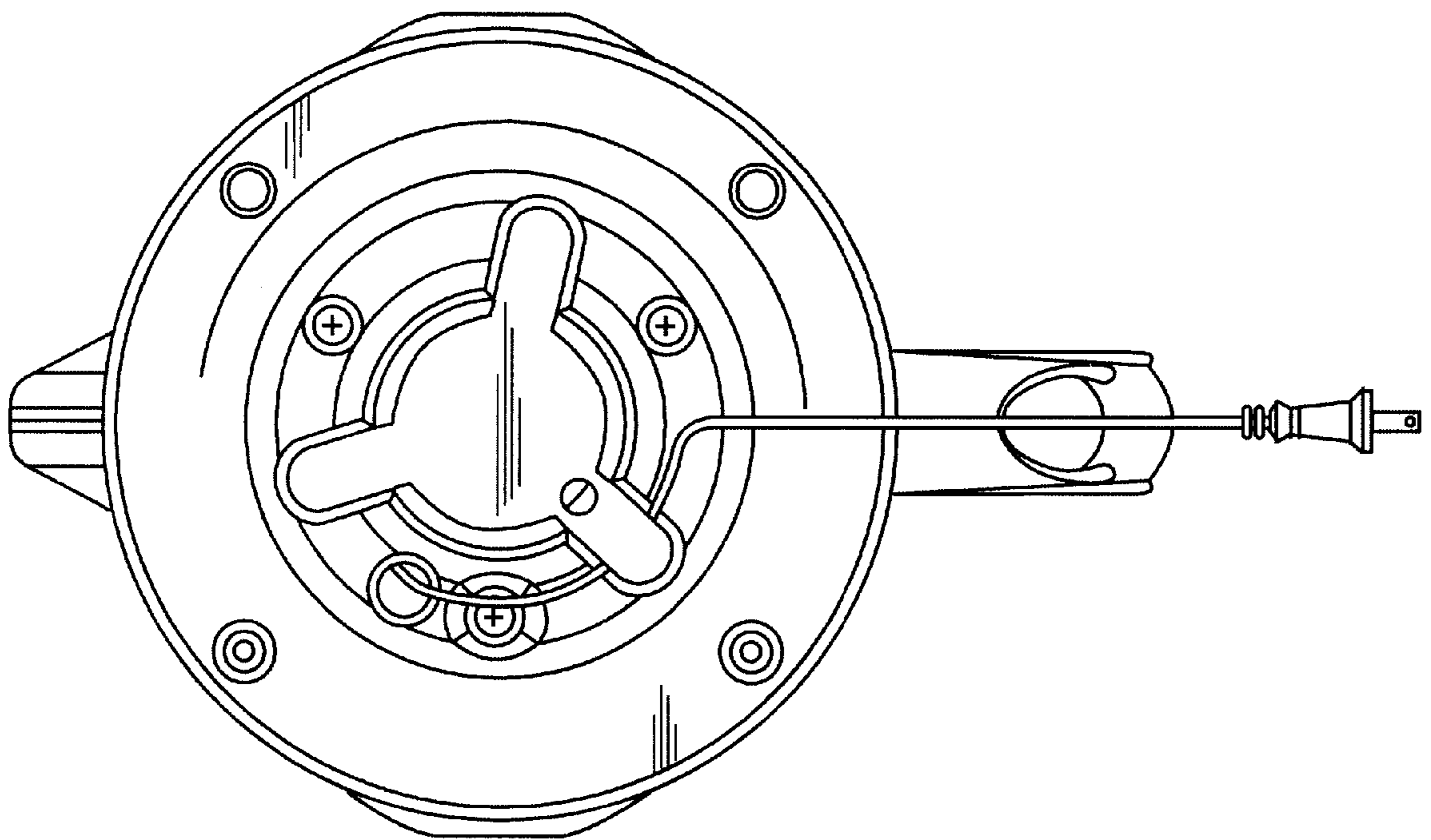

FIG. 6