



US00D447363B1

(12) **United States Design Patent**
Tharpe

(10) **Patent No.:** **US D447,363 S**

(45) **Date of Patent:** **** *Sep. 4, 2001**

(54) **MODEL AND COLLECTIBLE DISPLAY CASE**

* cited by examiner

Primary Examiner—Cathron B. Matta

(76) **Inventor:** **Xavier Tharpe**, 3318 Mountain Ave.,
San Bernardino, CA (US) 92404-2710

(57) **CLAIM**

(*) **Notice:** This patent is subject to a terminal disclaimer.

The ornamental design for a model and collectible display case, as shown and described.

(**) **Term:** **14 Years**

DESCRIPTION

(21) **Appl. No.:** **29/109,298**

FIG. 1 is a front elevational view of the model and collectible display case of the present invention;

(22) **Filed:** **Aug. 12, 1999**

FIG. 2 is a rear elevational view of the model and collectible display case of FIG. 1;

(51) **LOC (7) Cl.** **06-04**

FIG. 3 is a left side elevational view of the model and collectible display case of FIG. 1, the right view being a mirror image thereof;

(52) **U.S. Cl.** **D6/470; D6/559**

FIG. 4 is a right side elevational view of the model and collectible display case of FIG. 1, the left view being a mirror image thereof;

(58) **Field of Search** D6/396, 449, 470,
D6/553, 559, 560, 569, 571; 108/59, 60;
211/13.1, 87.01, 90.04, 134; 312/114, 117,
138.1

FIG. 5 is a top plan view of the model and collectible display case of FIG. 1;

(56) **References Cited**

U.S. PATENT DOCUMENTS

FIG. 6 is a bottom plan view of the model and collectible display case of FIG. 1; and,

- D. 322,725 * 12/1991 Strickland, III D6/470
- D. 325,313 * 4/1992 Evenson D6/571 X
- D. 367,196 * 2/1996 Mashal D6/559
- D. 374,364 * 10/1996 Morris D6/559
- D. 408,657 * 4/1999 Koch D6/470
- D. 418,347 * 1/2000 Dragonette D6/559
- D. 419,351 * 1/2000 Wenger et al. D6/553

FIG. 7 is a top, left side perspective view of the model and collectible display case of FIG. 1.

The broken line showing of a car in FIG. 7 is for illustrative purposes only and forms no part of the claimed design.

1 Claim, 3 Drawing Sheets

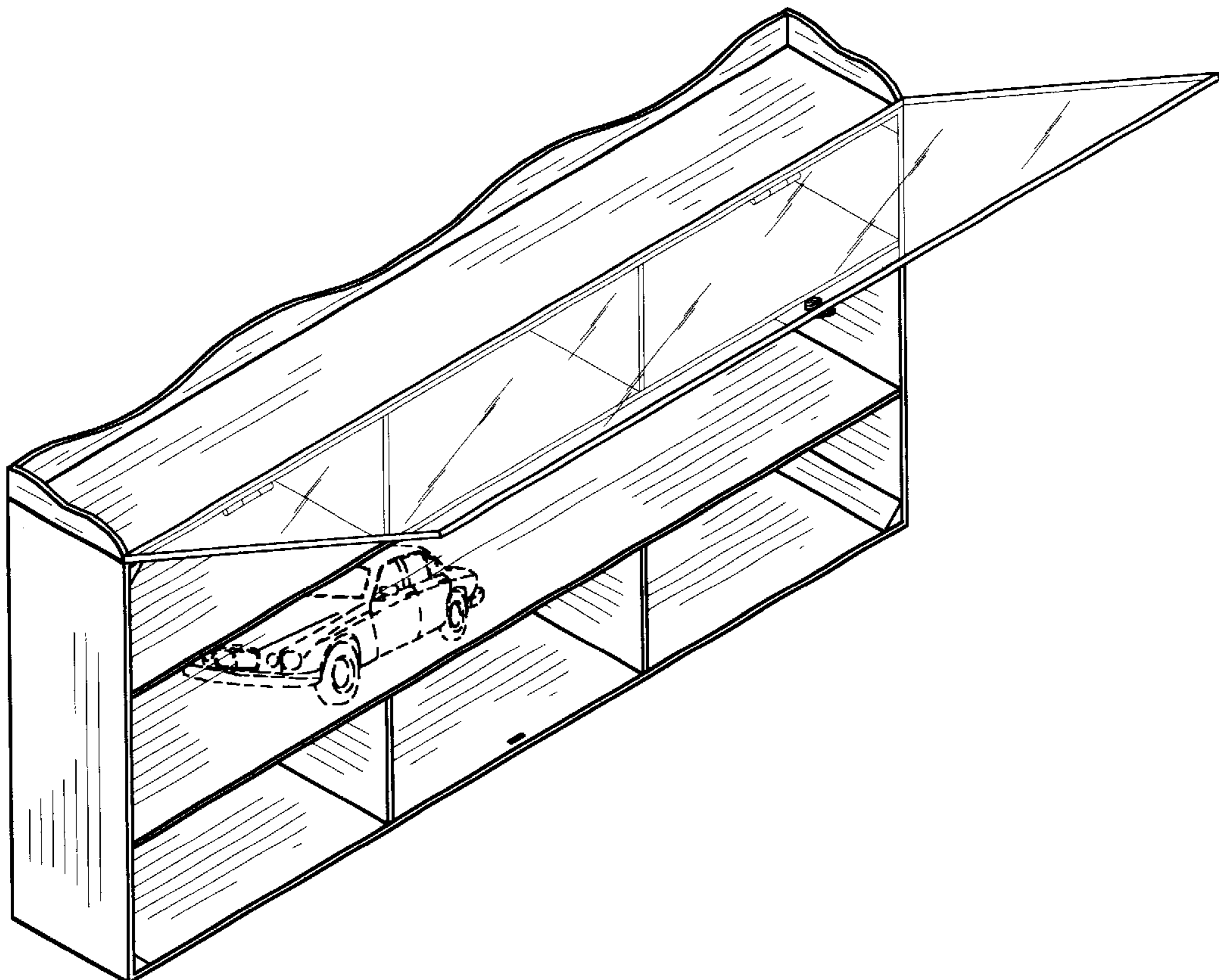

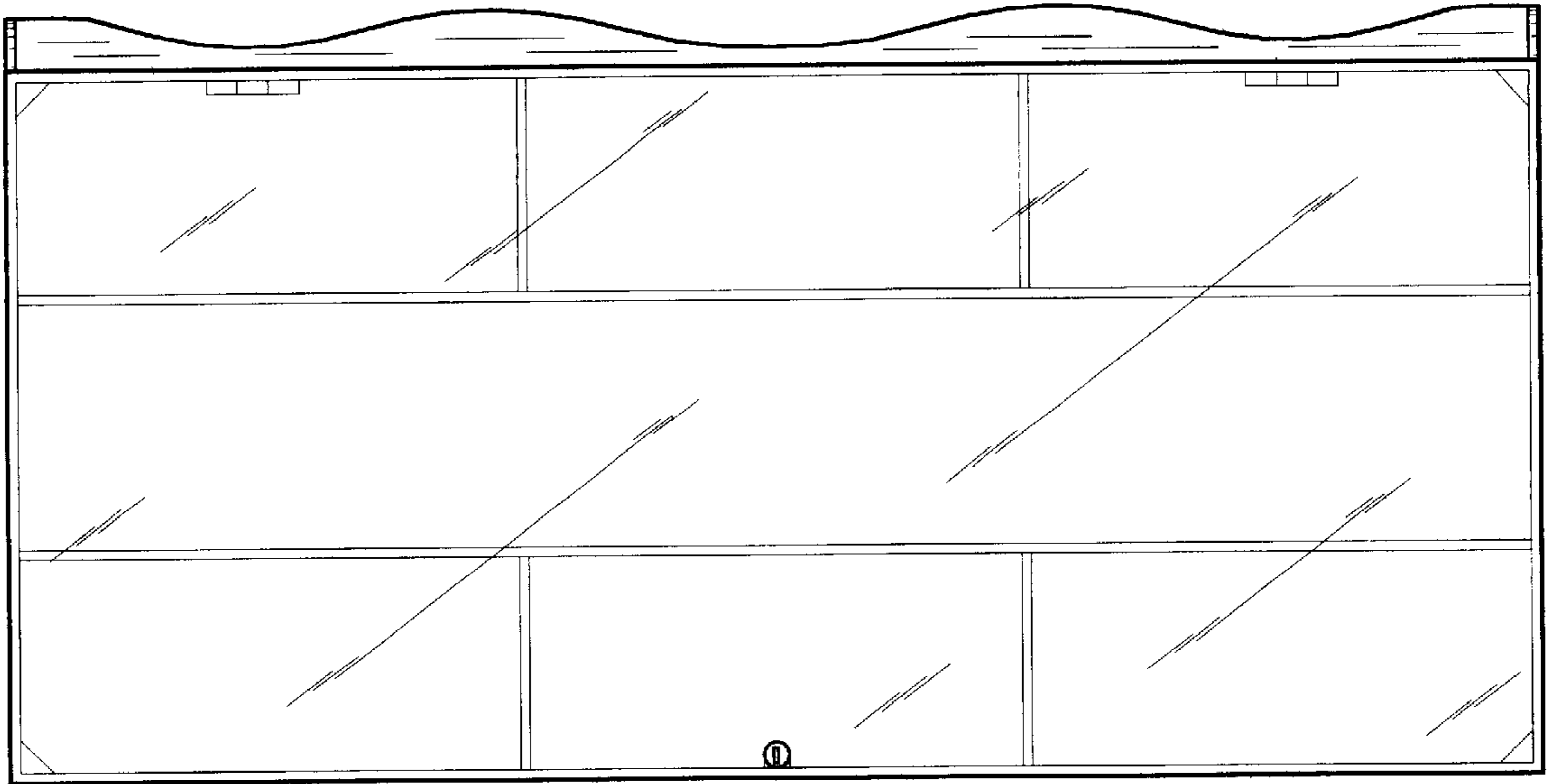

Fig. 1

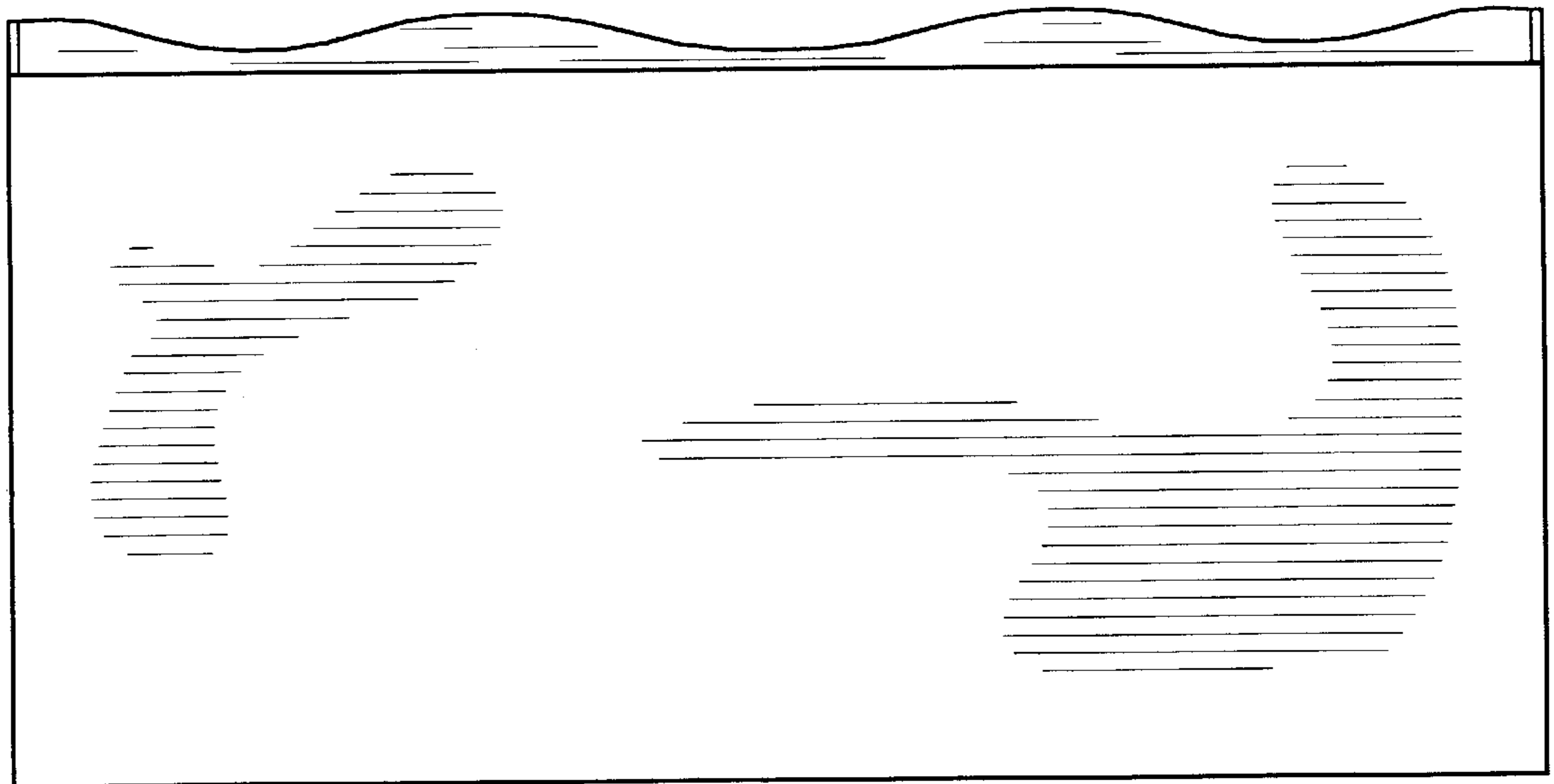

Fig. 2

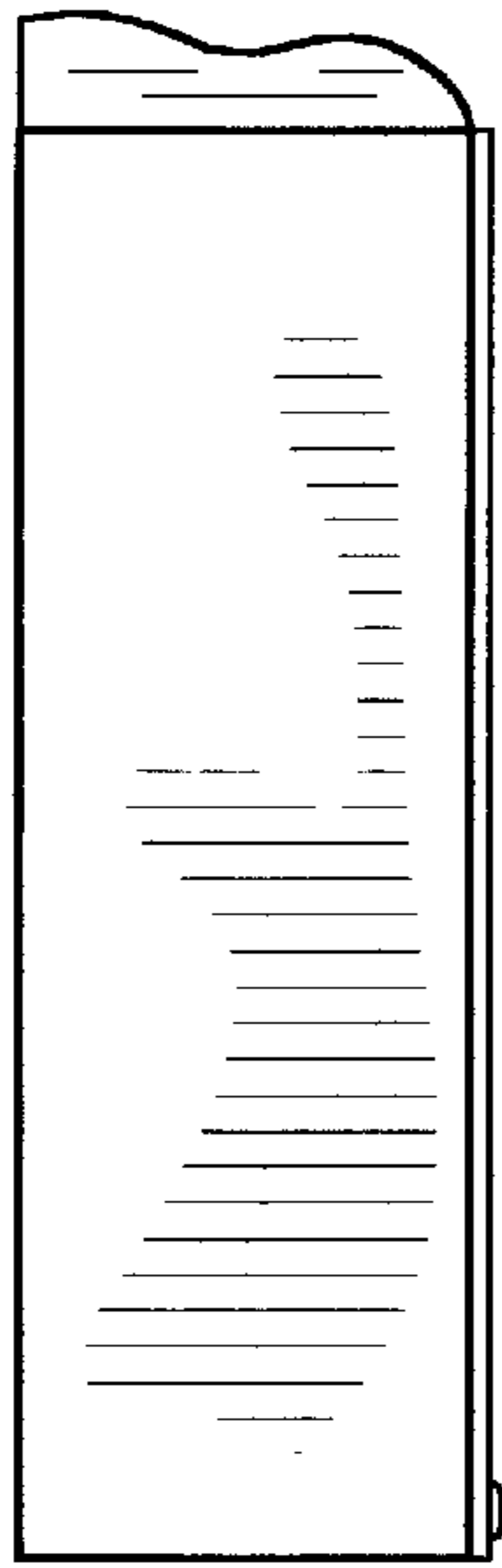

Fig. 3

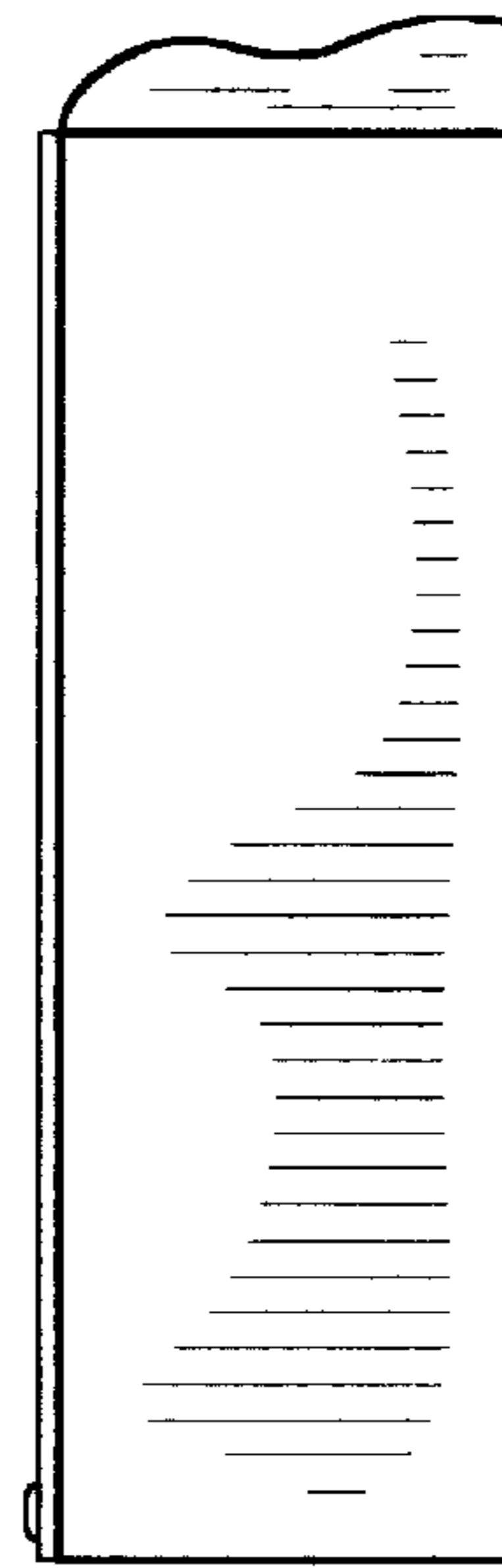

Fig. 4

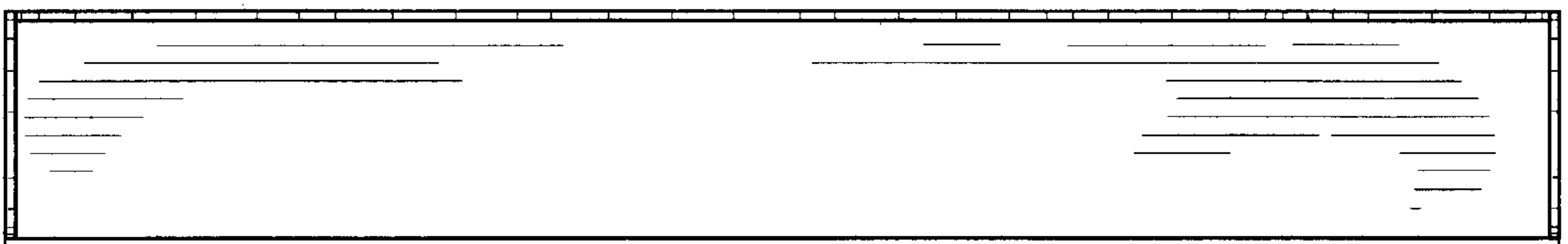

Fig. 5

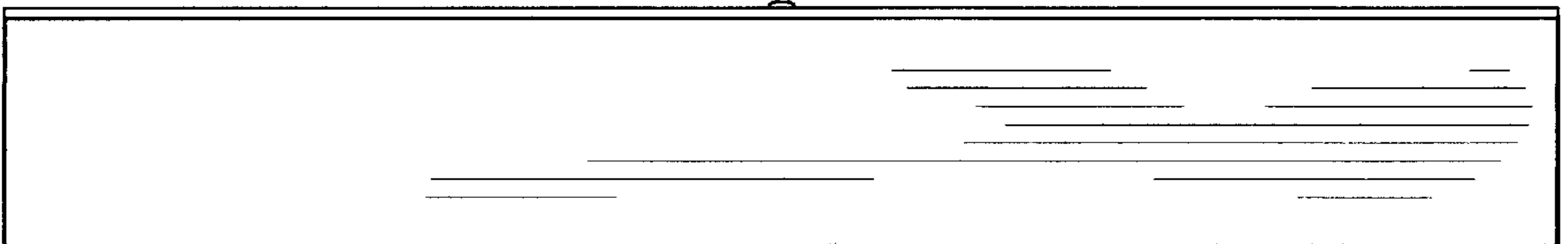

Fig. 6

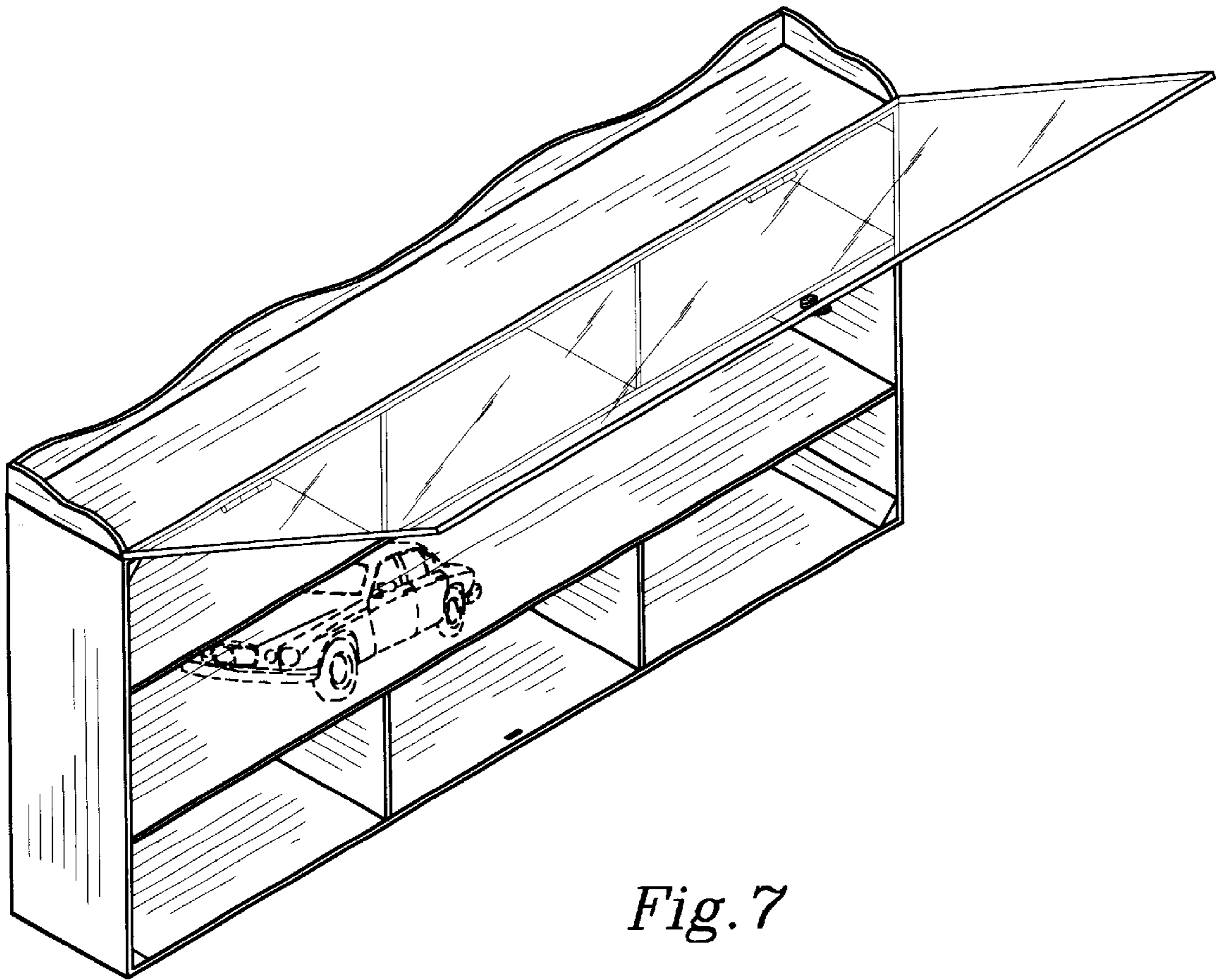

Fig. 7