



US00D447305B1

(12) **United States Design Patent**  
**Hughes**

(10) **Patent No.:** **US D447,305 S**

(45) **Date of Patent:** **\*\* Aug. 28, 2001**

(54) **RECEPTACLE**

(75) Inventor: **Aaron W. Hughes**, Burnham, PA (US)

(73) Assignee: **DuMor, Inc.**, Mifflintown, PA (US)

(\*\*) Term: **14 Years**

(21) Appl. No.: **29/131,401**

(22) Filed: **Oct. 20, 2000**

(51) **LOC (7) Cl.** ..... **09-09**

(52) **U.S. Cl.** ..... **D34/1**

(58) **Field of Search** ..... D34/1, 5, 6; 220/908,  
220/909, 910, 911; D9/556; D19/85

(56) **References Cited**

**U.S. PATENT DOCUMENTS**

D. 304,253	10/1989	Skalka	.....	D34/6
D. 305,470	* 1/1990	Yoshikawa	.....	D34/1
D. 305,471	* 1/1990	Yoshikawa	.....	D34/1
D. 306,928	3/1990	Hanna	.....	D34/5
D. 314,461	2/1991	Skalka	.....	D34/5
D. 322,702	12/1991	Skalka	.....	D34/5
D. 338,302	* 8/1993	Shafer	.....	D34/1
D. 353,250	12/1994	Skalka	.....	D34/1
D. 397,361	8/1998	Goodman et al.	.....	D19/85
D. 398,649	9/1998	Ricci	.....	D19/85
D. 417,053	11/1999	Skalka	.....	D34/6
D. 431,703	* 10/2000	Licari	.....	D34/1
D. 433,205	* 10/2000	Cayouette	.....	D34/1

**OTHER PUBLICATIONS**

Keystone Ridge Designs, Inc., "Premier Site Furniture", catalog Apr. 1997, 20 pages; pp. 4-6, 10-13, 15-17 illustrate receptacles.

Victor Stanley, Inc., "Excellence in Site Amenities", 8 page brochure; pp. 1 and 6 illustrate receptacles.

DuMor, Inc., 2000 Site Furnishings Catalog, 49 pages; pp. 3, 4, 8-10, 12, 14, 15, 19, 21, 24, 28, 29, 33, 36, 38 and 40 illustrate receptacles.

\* cited by examiner

*Primary Examiner*—Cynthia E. Ramirez

(74) *Attorney, Agent, or Firm*—Thomas Hooker, P.C.

(57) **CLAIM**

The ornamental design for a receptacle, as shown and described.

**DESCRIPTION**

FIG. 1 is a front and top perspective view of a receptacle showing a first embodiment of my new design; FIG. 2 is a front elevation view of the receptacle of FIG. 1; FIG. 3 is a side elevation view of the receptacle of FIG. 1; FIG. 4 is a top plan view of the receptacle of FIG. 1; FIG. 5 is a bottom plan view of the receptacle of FIG. 1; FIG. 6 is a front and top perspective view of a receptacle showing a second embodiment of my new design; FIG. 7 is a front elevation view of the receptacle of FIG. 6; FIG. 8 is a side elevation view of the receptacle of FIG. 6; FIG. 9 is a top plan view of the receptacle of FIG. 6; FIG. 10 is a bottom plan view of the receptacle of FIG. 6; FIG. 11 is a front and top perspective view of a receptacle showing a third embodiment of my new design; FIG. 12 is a front elevation view of the receptacle of FIG. 11; FIG. 13 is a side elevation view of the receptacle of FIG. 11; FIG. 14 is a top plan view of the receptacle of FIG. 11; and, FIG. 15 is a bottom plan view of the receptacle of FIG. 11. The broken line showing of environmental structure in FIGS. 1-15 are for illustrative purposes only and form no part of the claimed design.

**1 Claim, 3 Drawing Sheets**

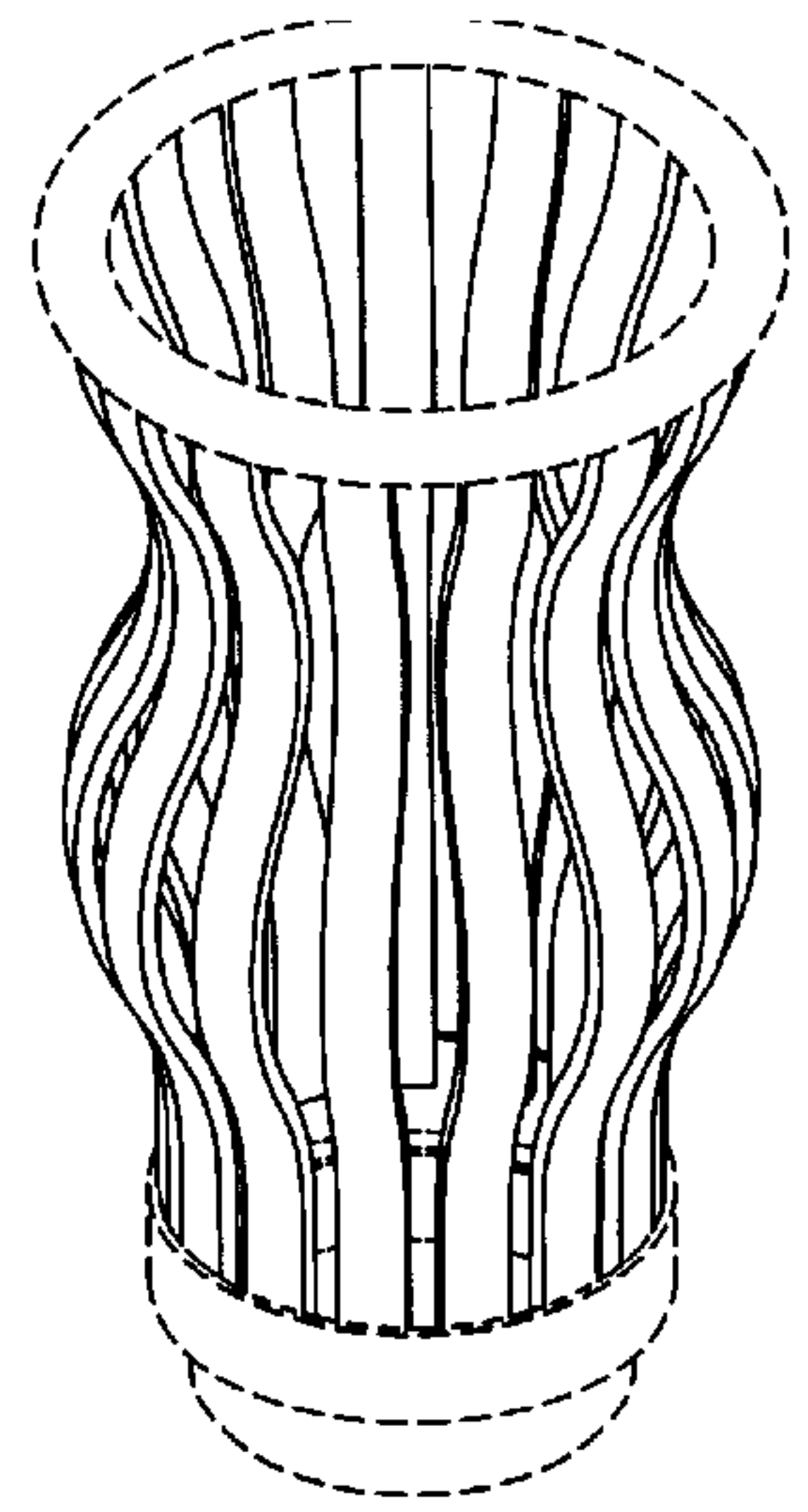
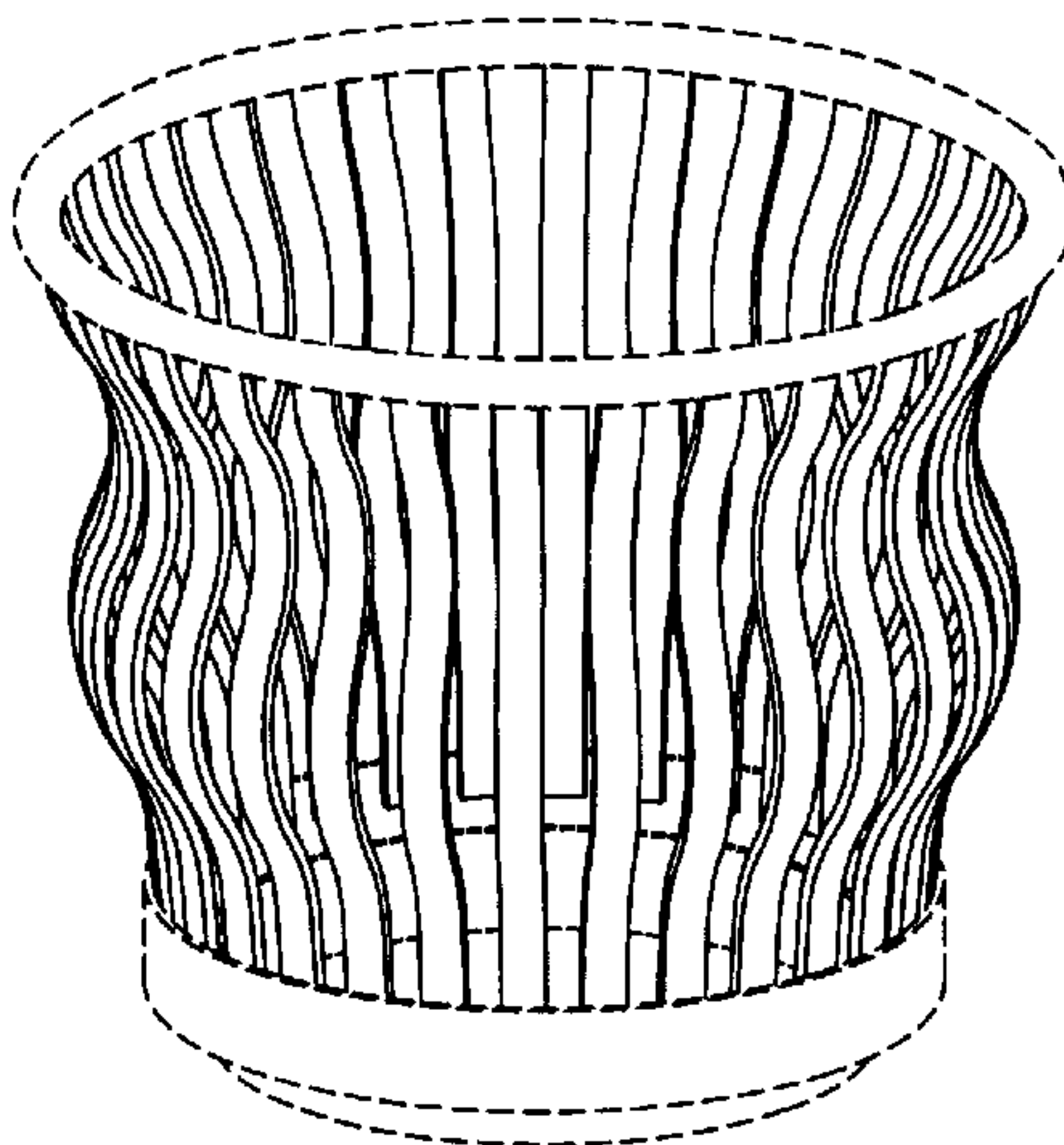
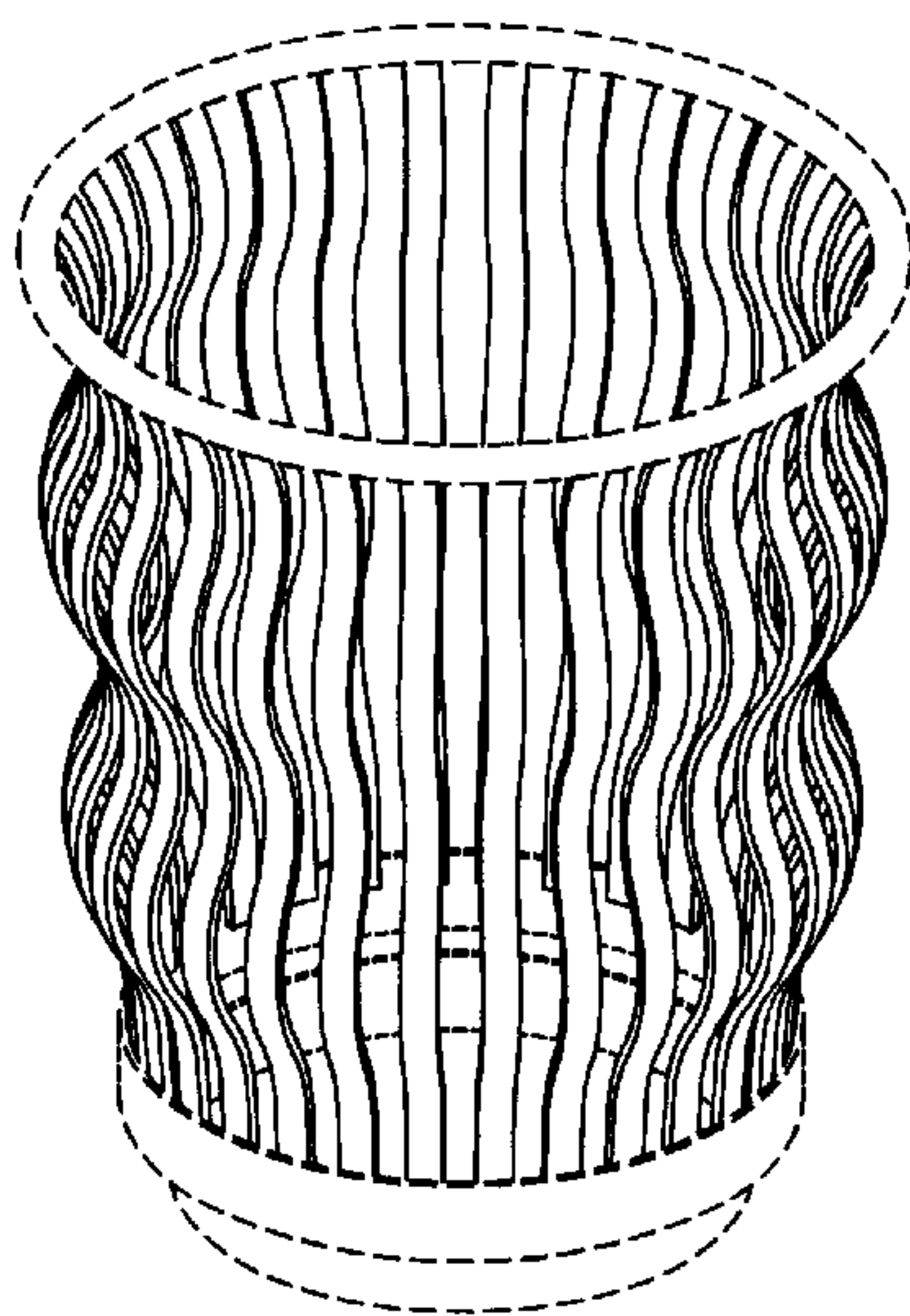

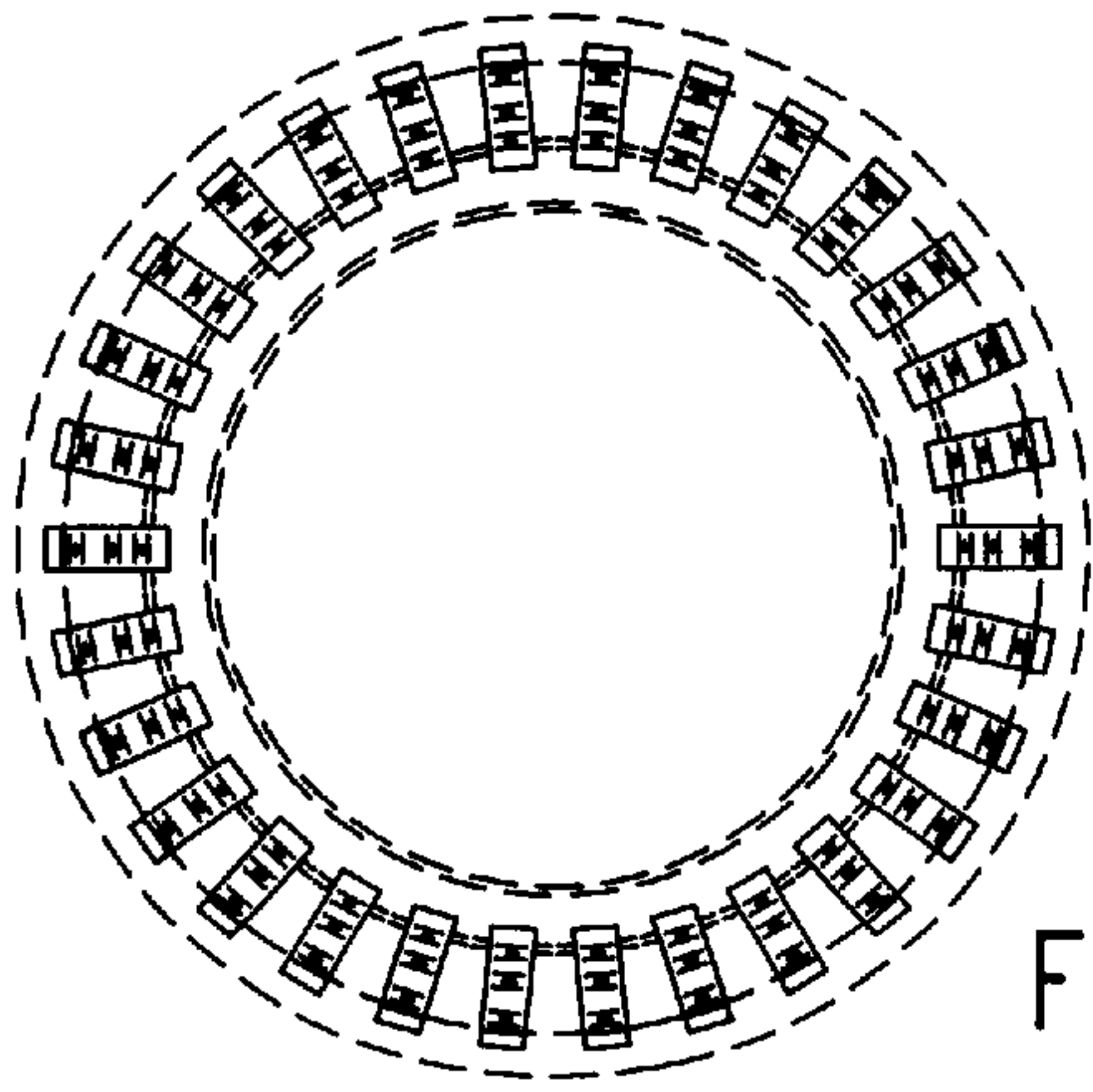

FIG. 4

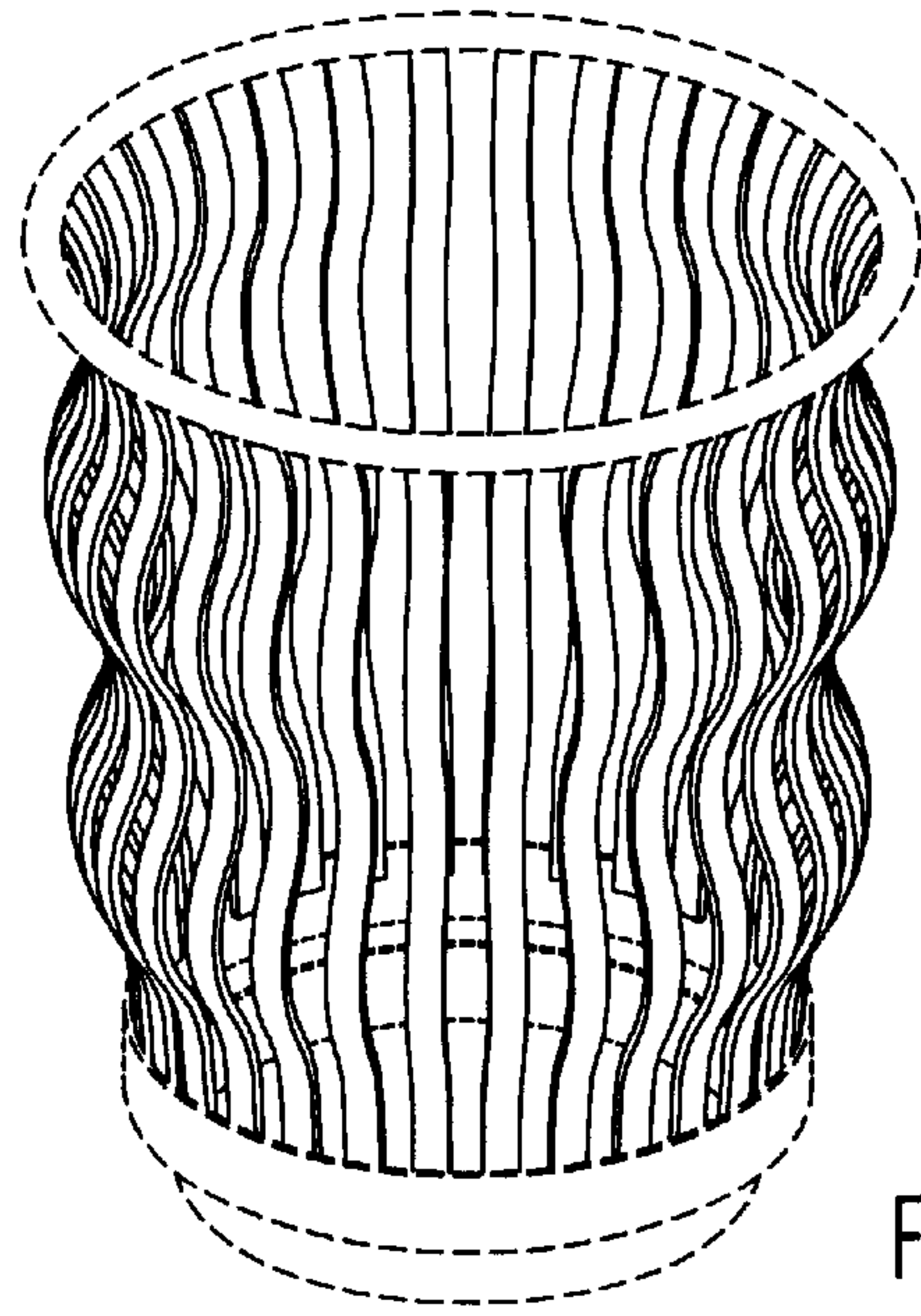

FIG. 1

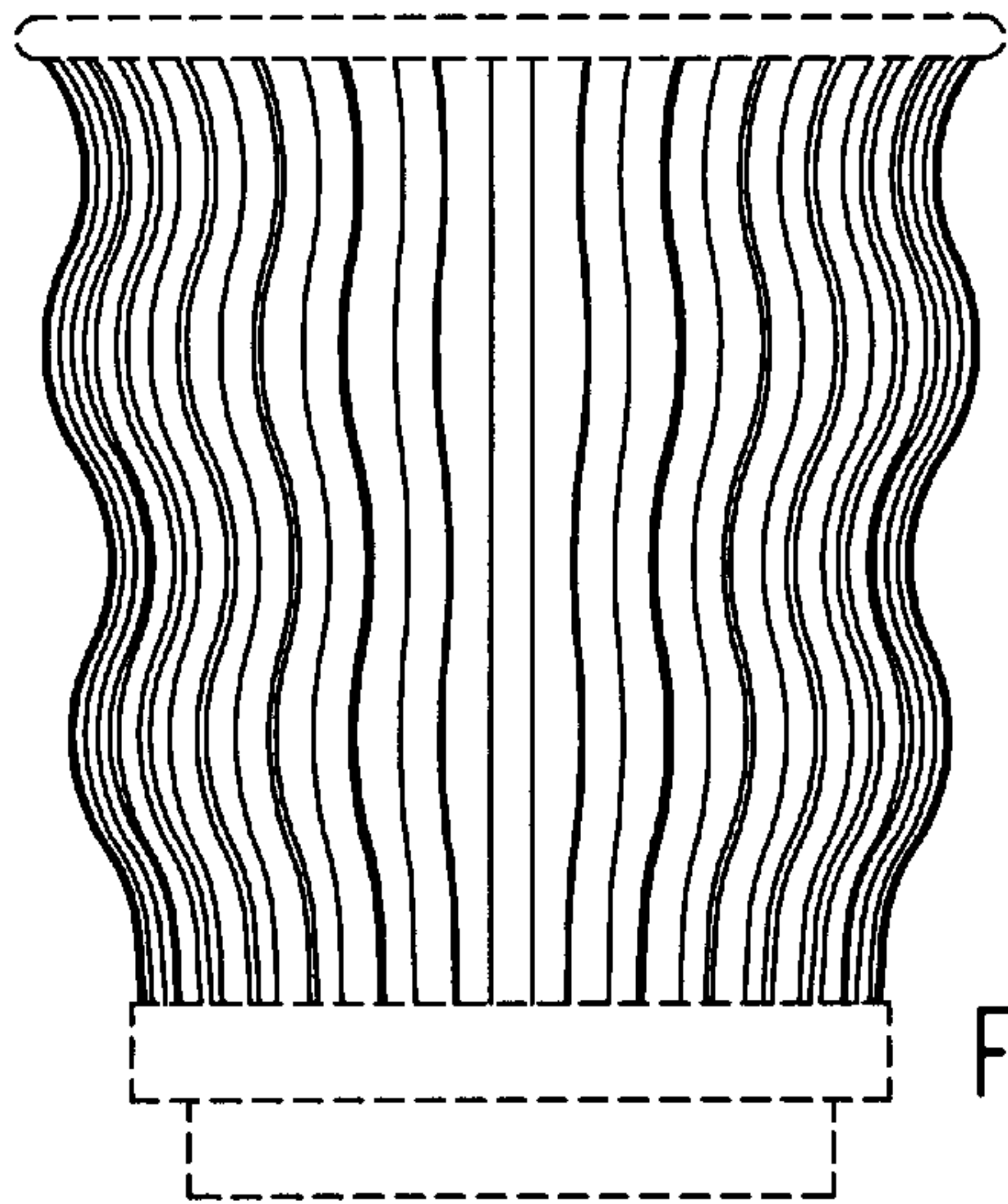

FIG. 3

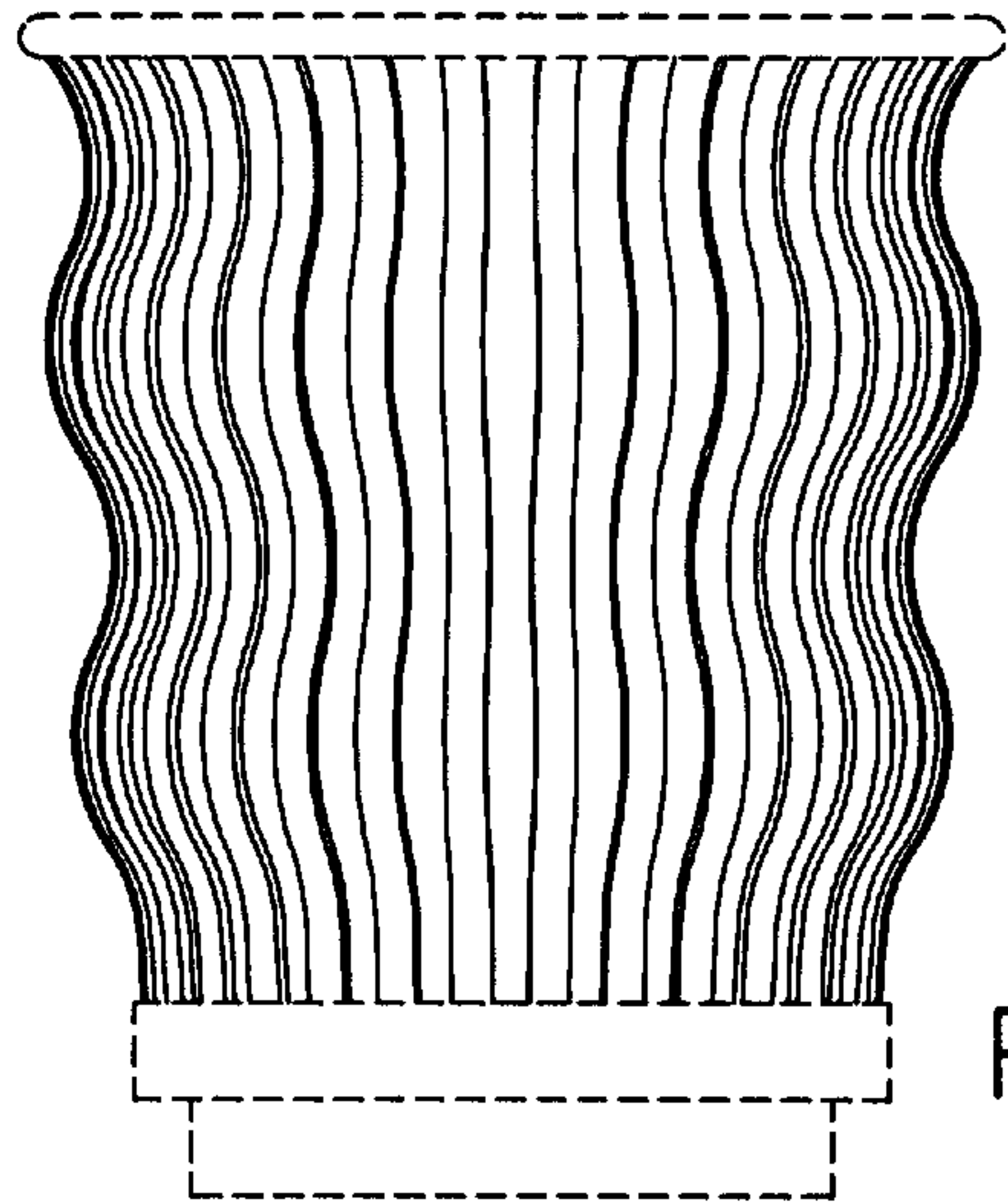

FIG. 2

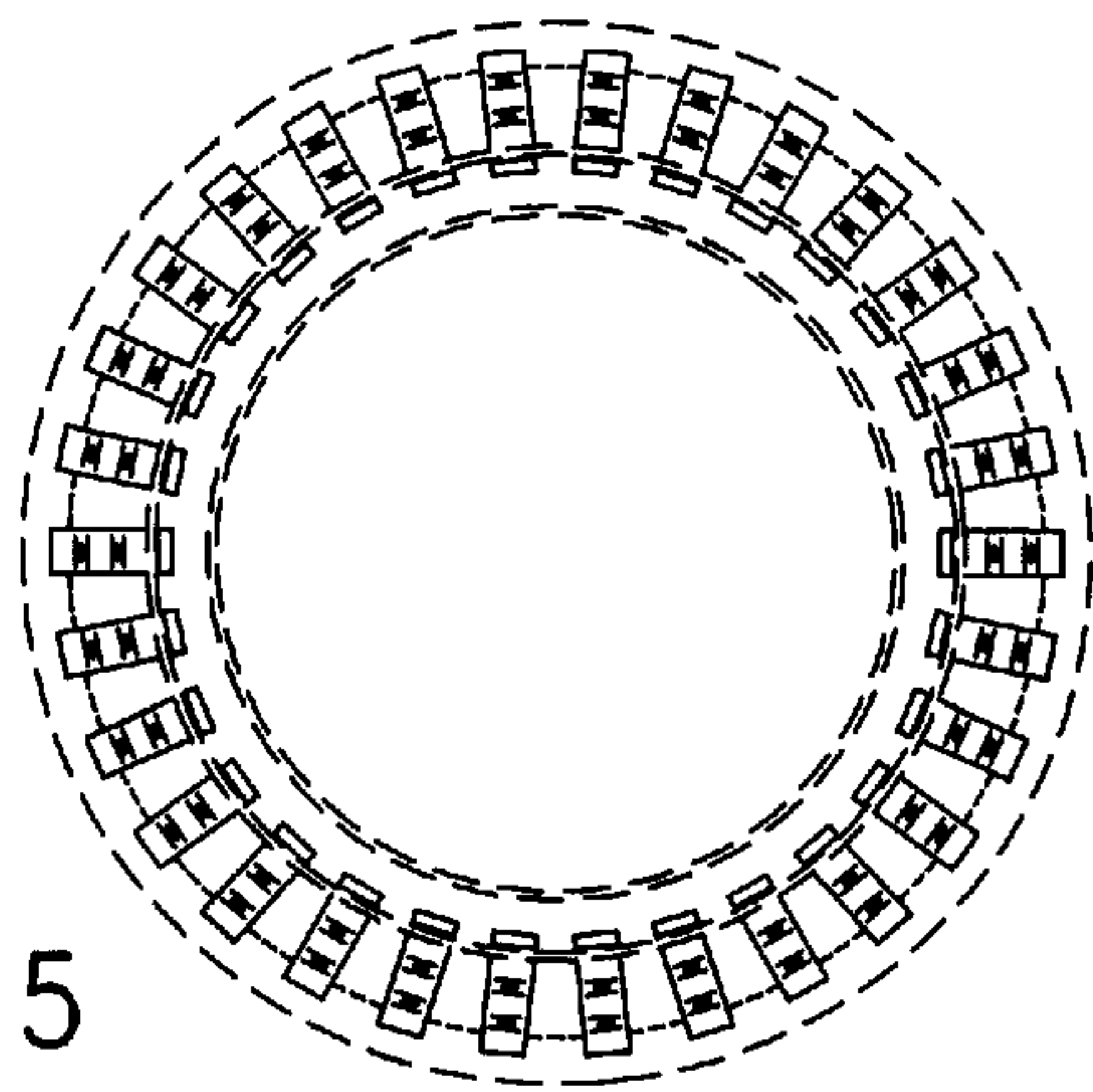

FIG. 5



FIG. 9

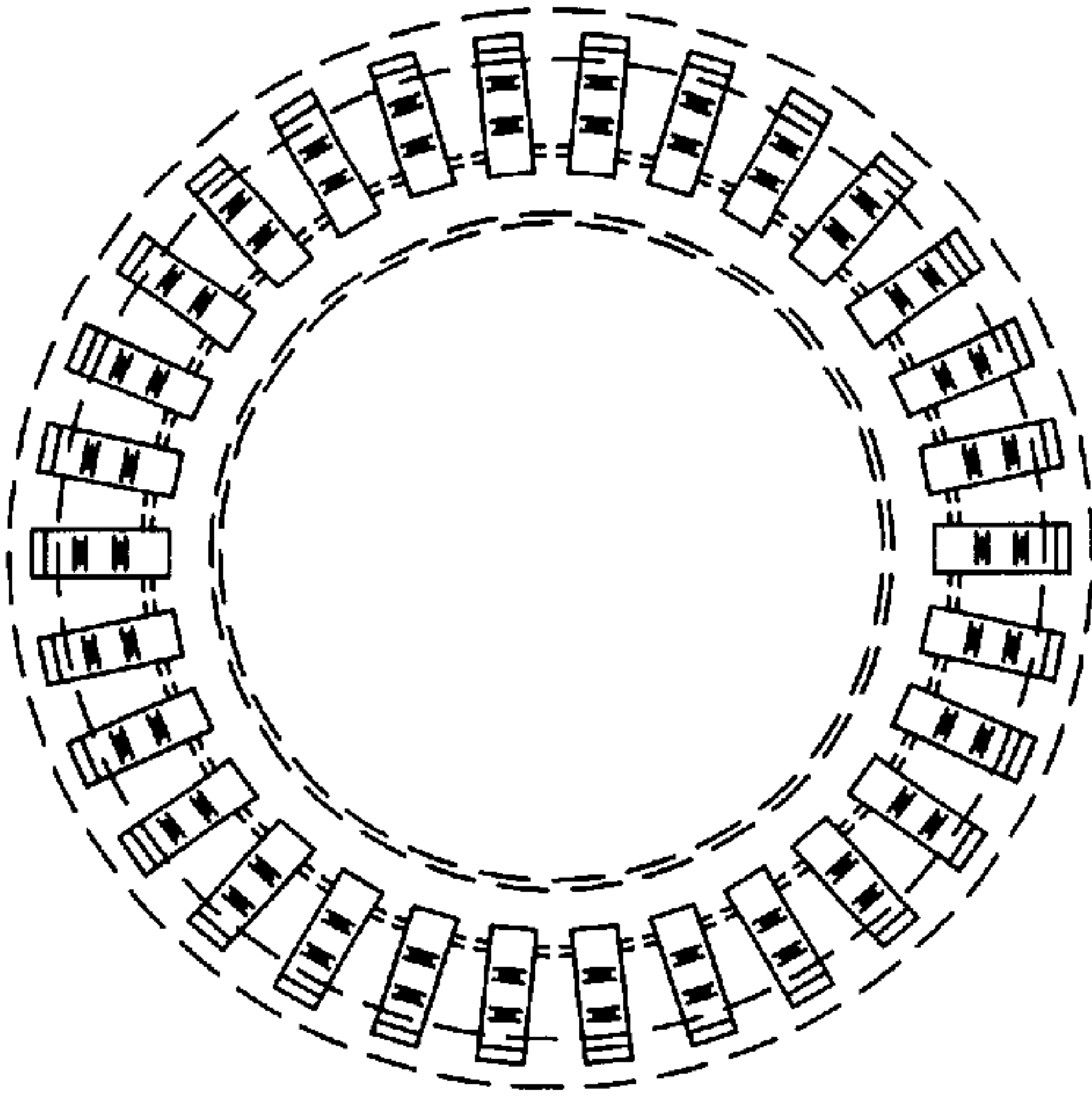

FIG. 6

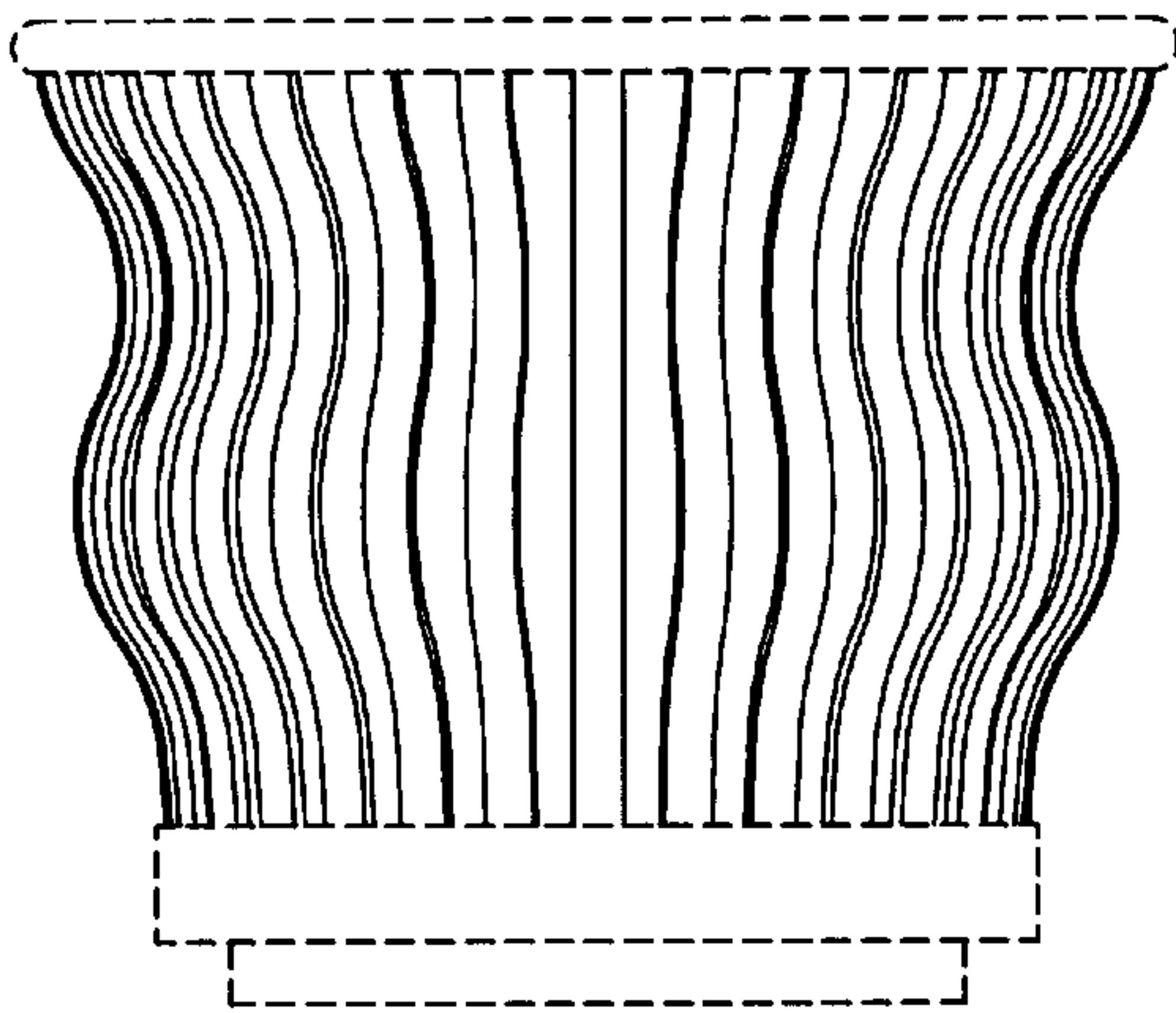
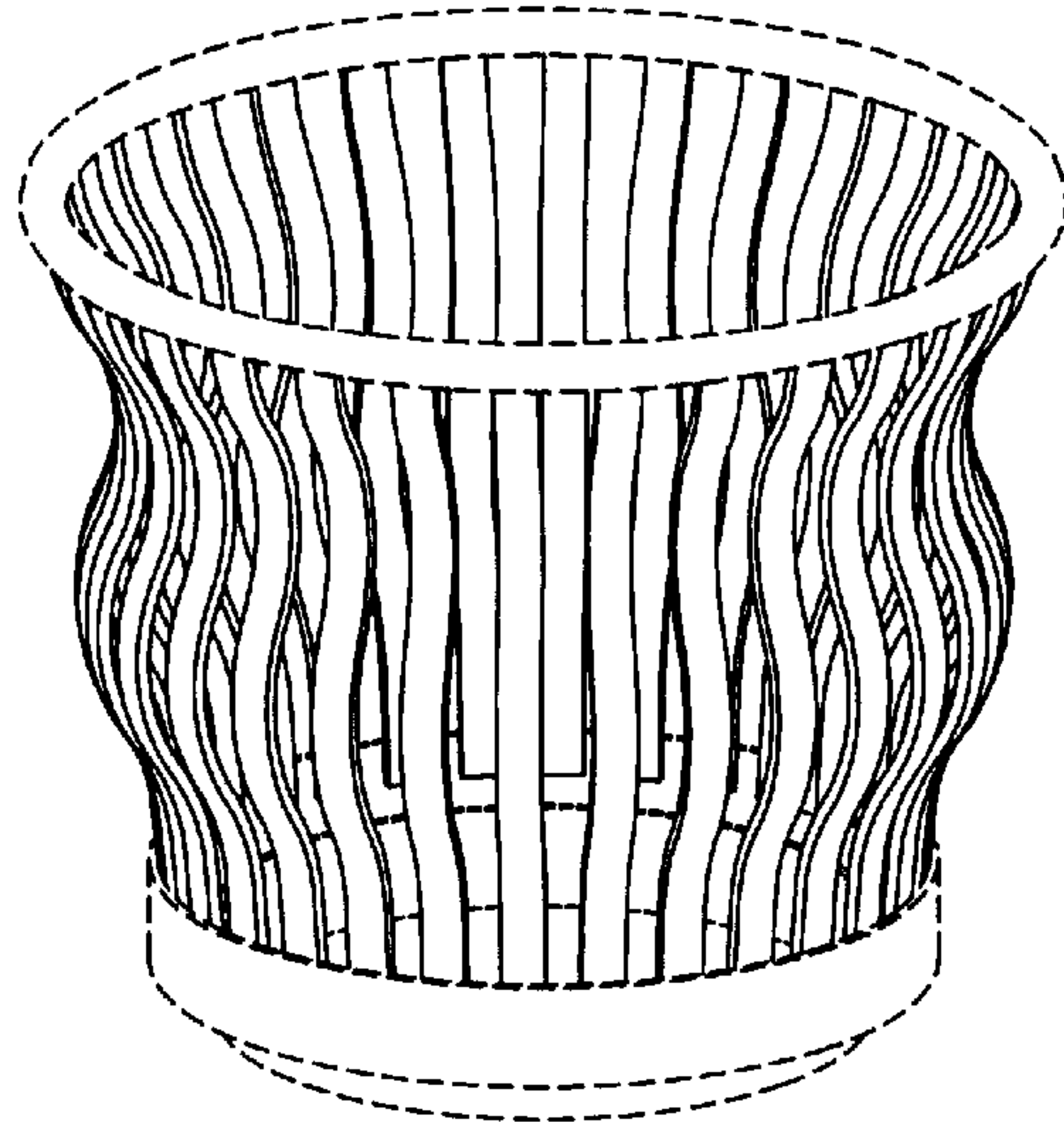

FIG. 8

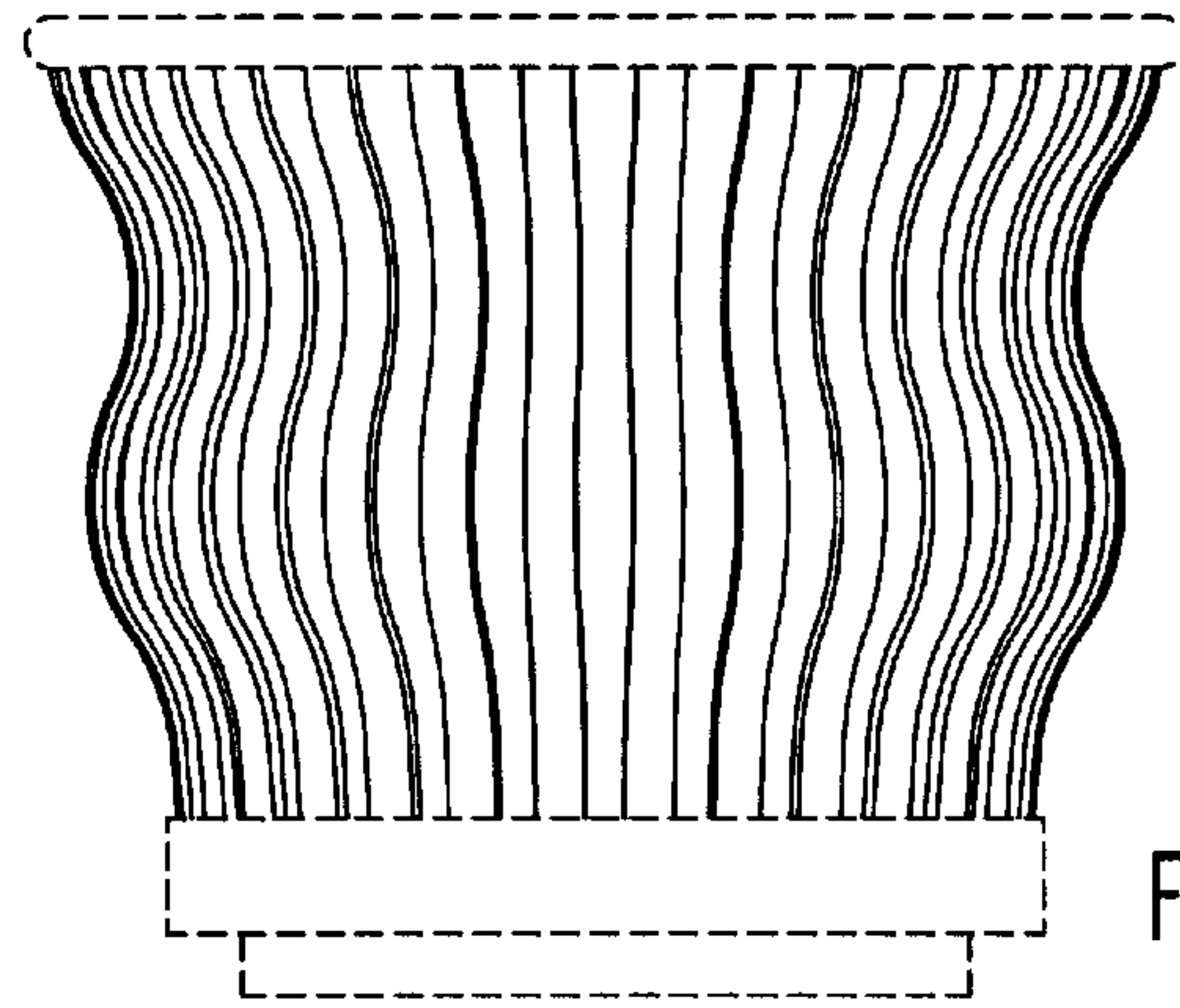
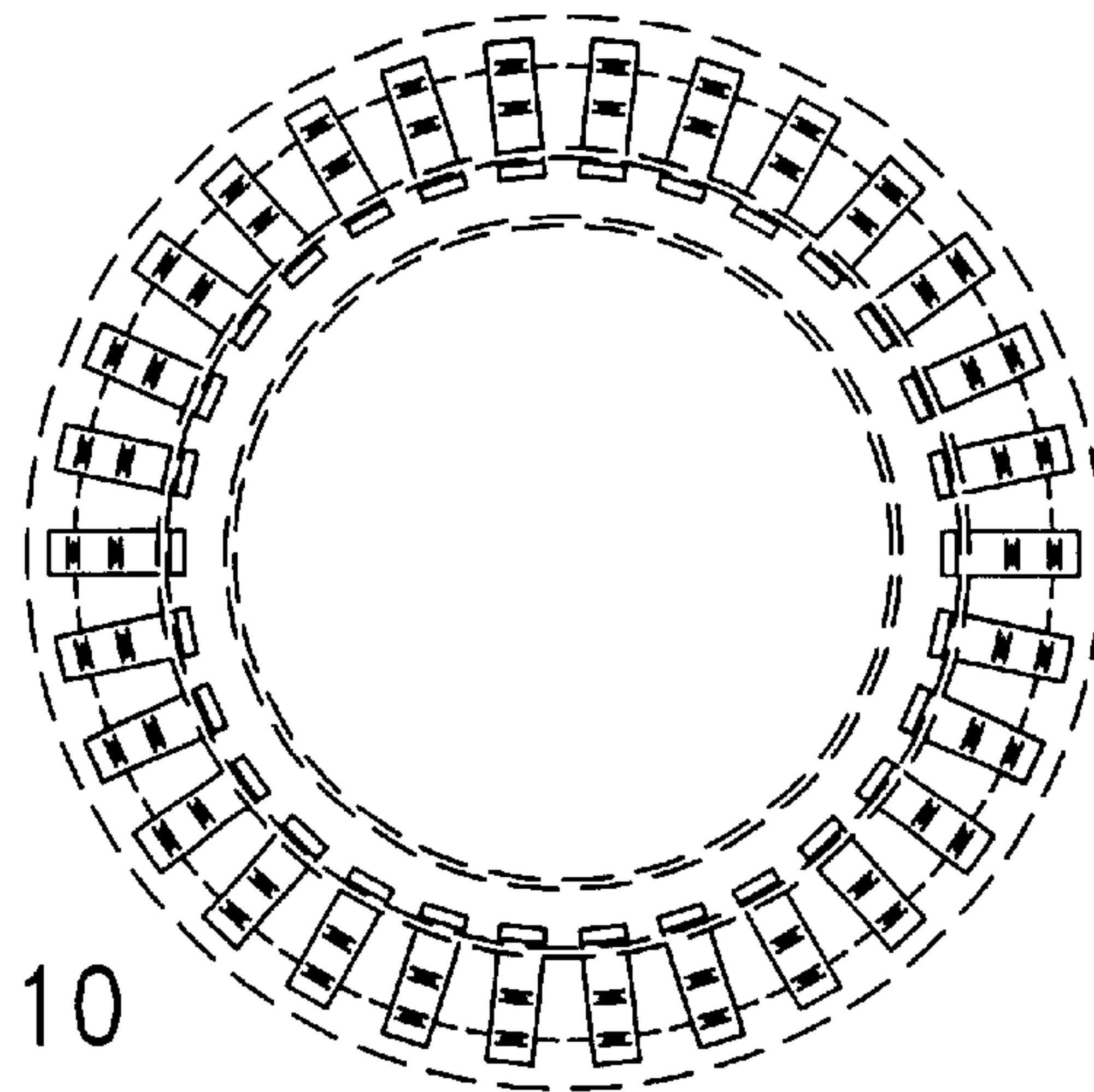

FIG. 7

FIG. 10



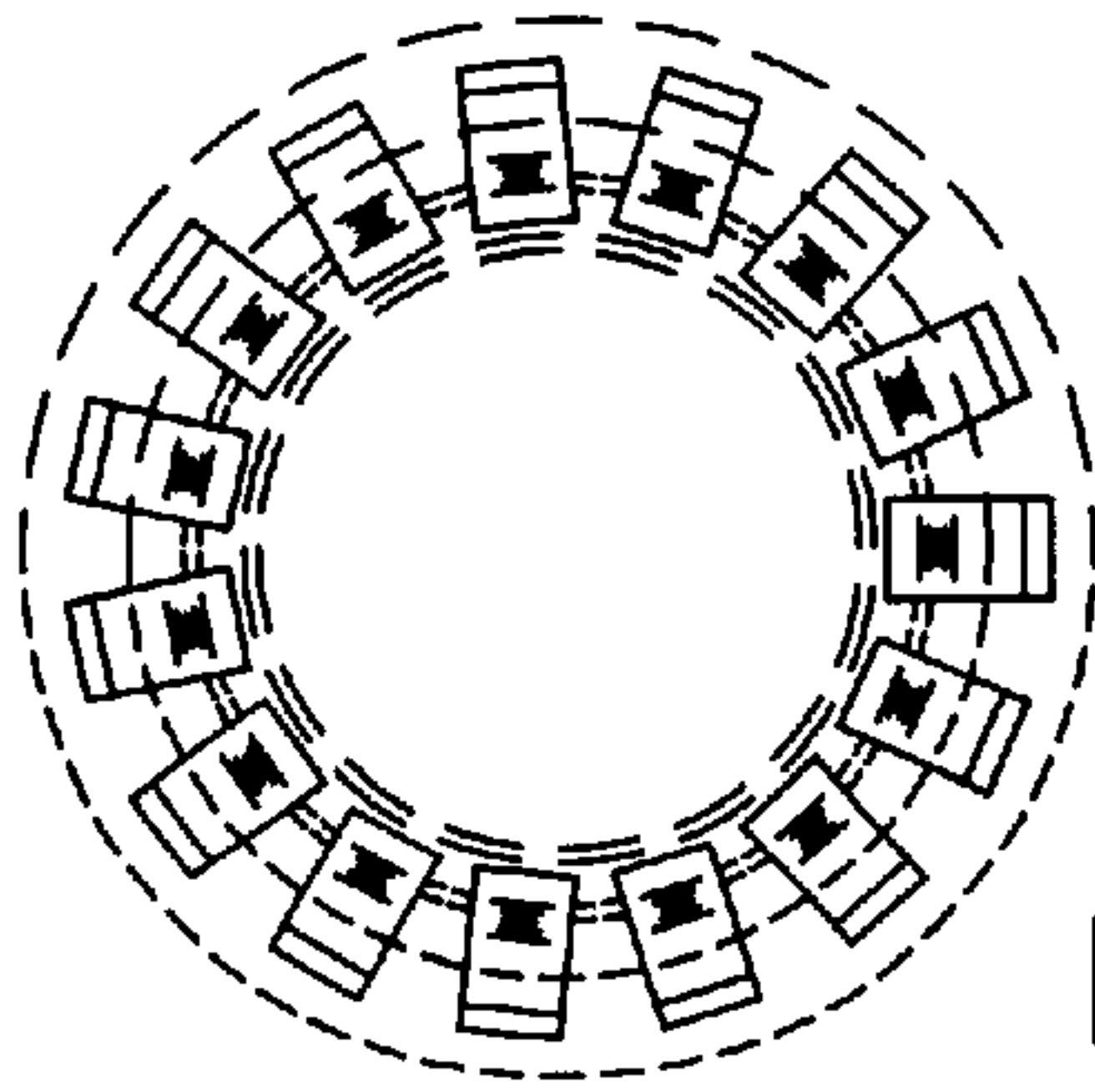

FIG. 14

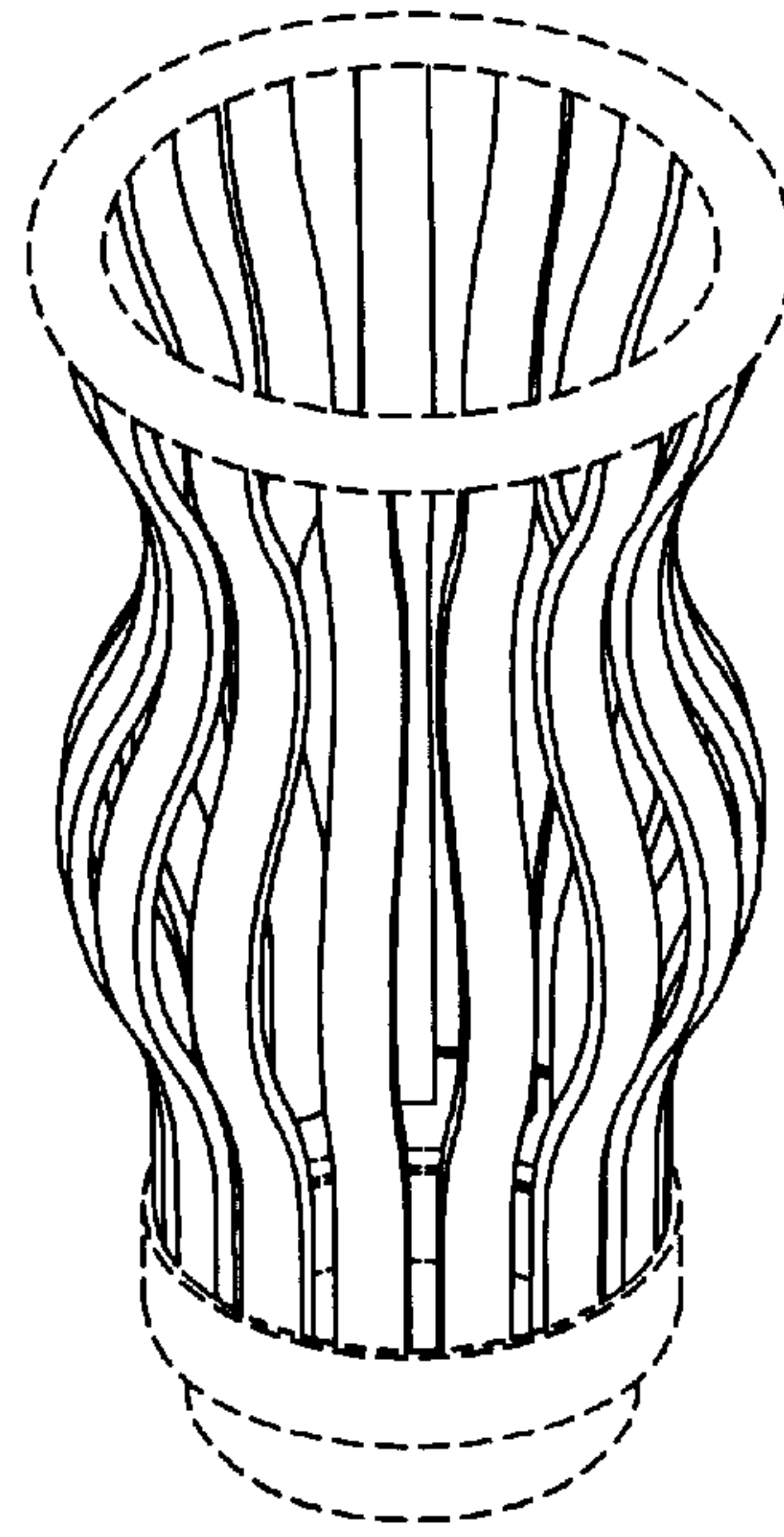

FIG. 11

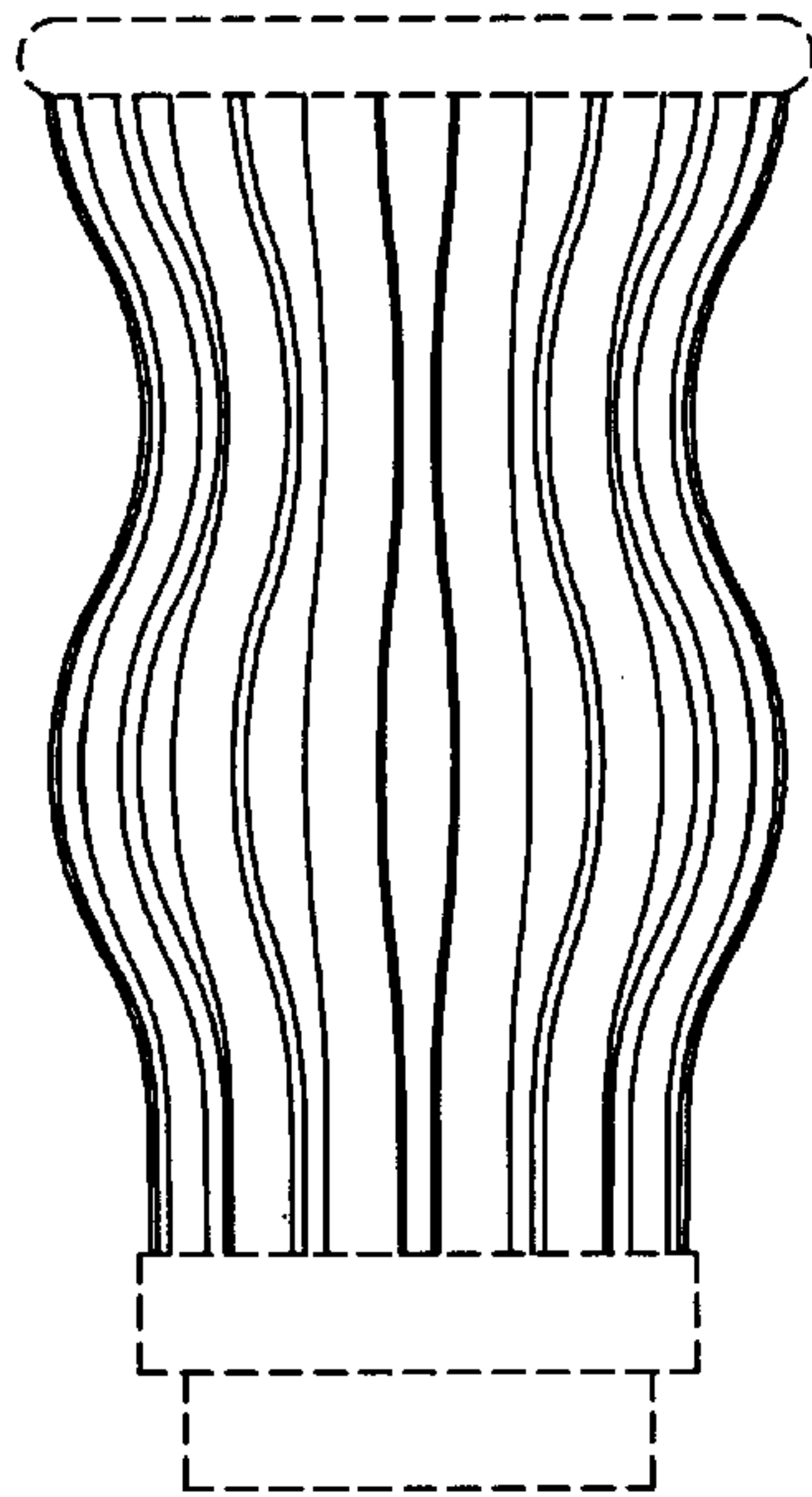

FIG. 13

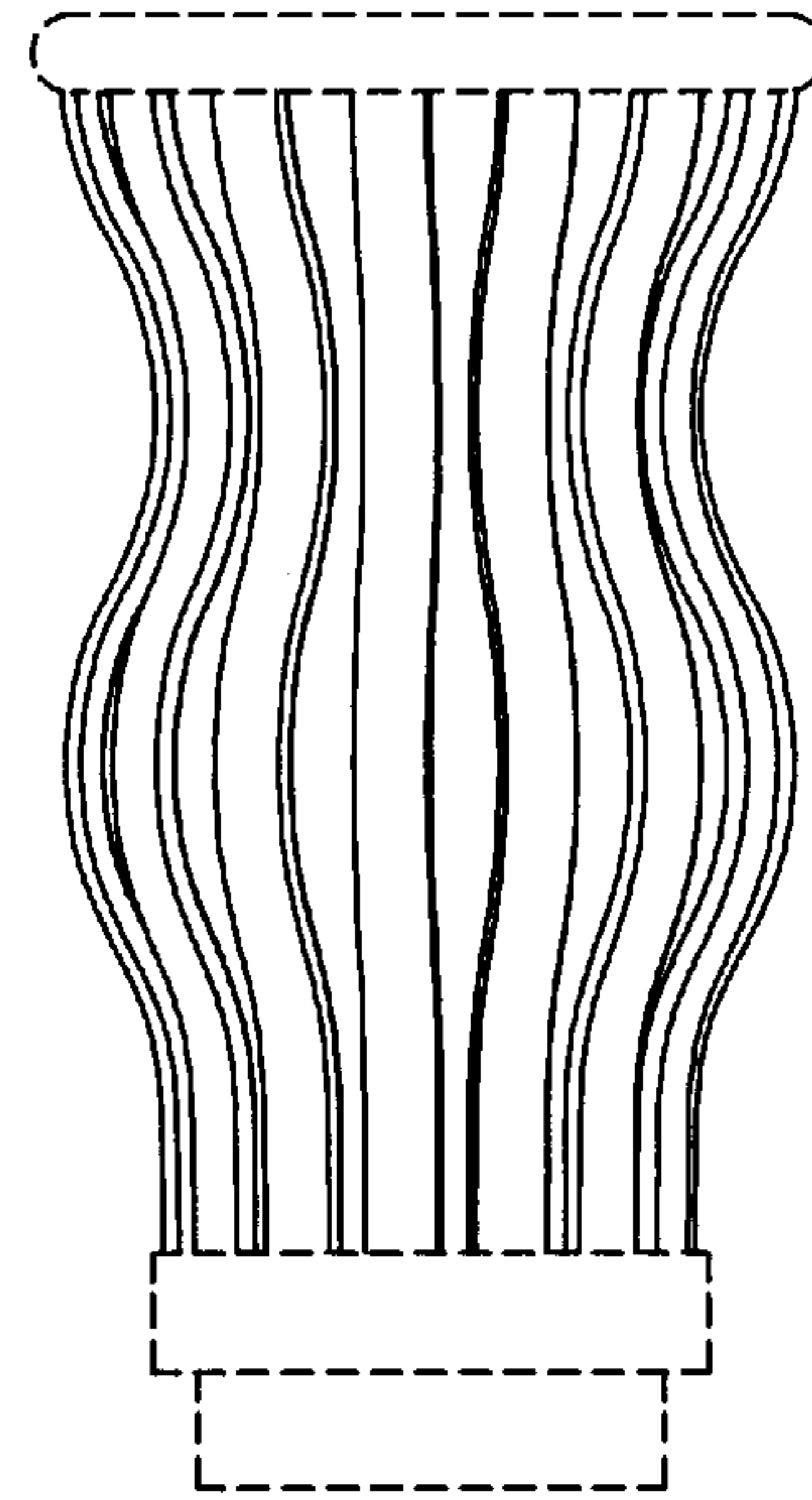

FIG. 12

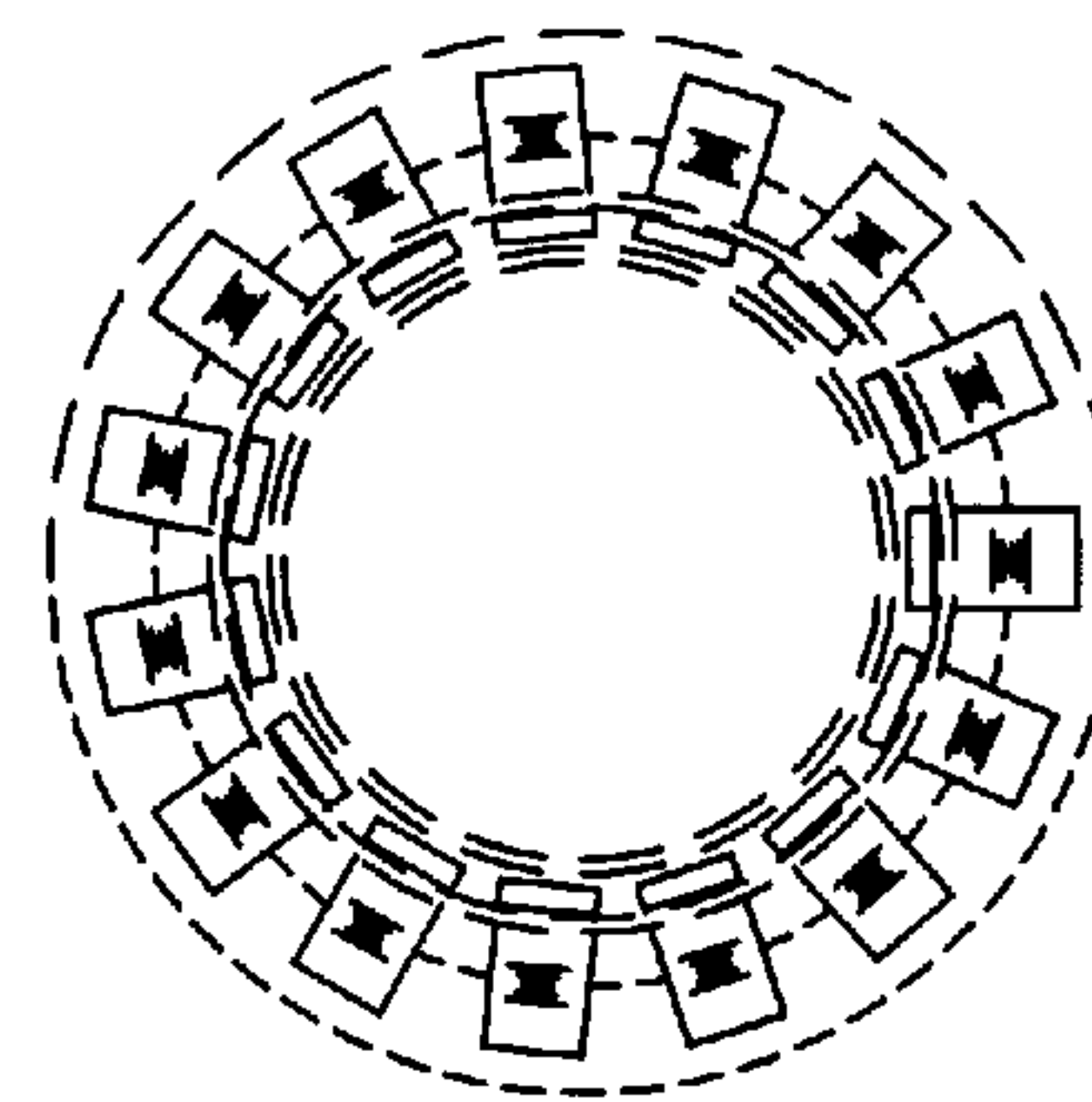

FIG. 15