



US00D447287B1

(12) **United States Design Patent**  
**Ho**

(10) **Patent No.:** **US D447,287 S**

(45) **Date of Patent:** **\*\* Aug. 28, 2001**

(54) **SAFETY HELMET**

(76) Inventor: **Chang-Hsien Ho**, 10F, No. 27, Lane  
40, Yu-Min 1st Rd., Peitou Dist., Taipei  
(TW)

(\*\*) Term: **14 Years**

(21) Appl. No.: **29/129,409**

(22) Filed: **Sep. 15, 2000**

(51) **LOC (7) Cl.** ..... **29-02**

(52) **U.S. Cl.** ..... **D29/102**

(58) **Field of Search** ..... D29/102-107,  
D29/108, 112, 122; 2/6.1, 6.6, 410-411,  
413, 421, 423-425, 209

(56) **References Cited**

**U.S. PATENT DOCUMENTS**

- D. 414,585 \* 9/1999 Ho ..... D29/102
- D. 424,246 \* 5/2000 Ho ..... D29/102
- D. 426,032 \* 5/2000 Ho ..... D29/102
- D. 426,677 \* 6/2000 Ho ..... D29/102
- D. 427,727 \* 7/2000 Ho ..... D29/102

D. 428,534 \* 7/2000 Ho ..... D29/102

D. 436,694 \* 1/2001 Ho ..... D29/102

D. 436,695 \* 1/2001 Ho ..... D29/102

\* cited by examiner

*Primary Examiner*—Ruth McInroy

(74) *Attorney, Agent, or Firm*—Dougherty & Troxell

(57) **CLAIM**

The ornamental design for a safety helmet, shown and described.

**DESCRIPTION**

FIG. 1 is a front side perspective view of a safety helmet showing our new design;

FIG. 2 is a rear side perspective view thereof;

FIG. 3 is a front elevational view thereof;

FIG. 4 is a rear elevational view thereof;

FIG. 5 is a left side elevational view thereof;

FIG. 6 is a right side elevational view thereof;

FIG. 7 is a top view thereof; and,

FIG. 8 is a bottom view thereof.

**1 Claim, 5 Drawing Sheets**

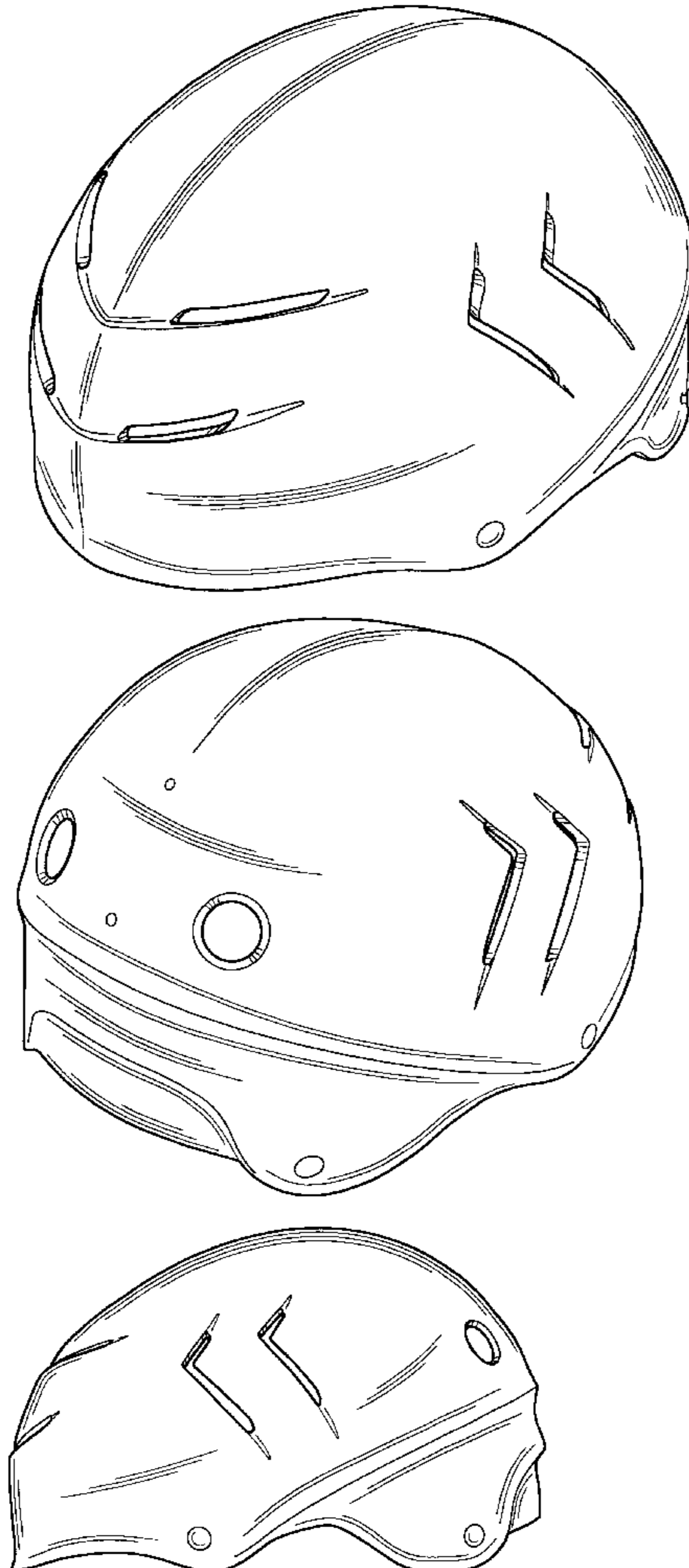

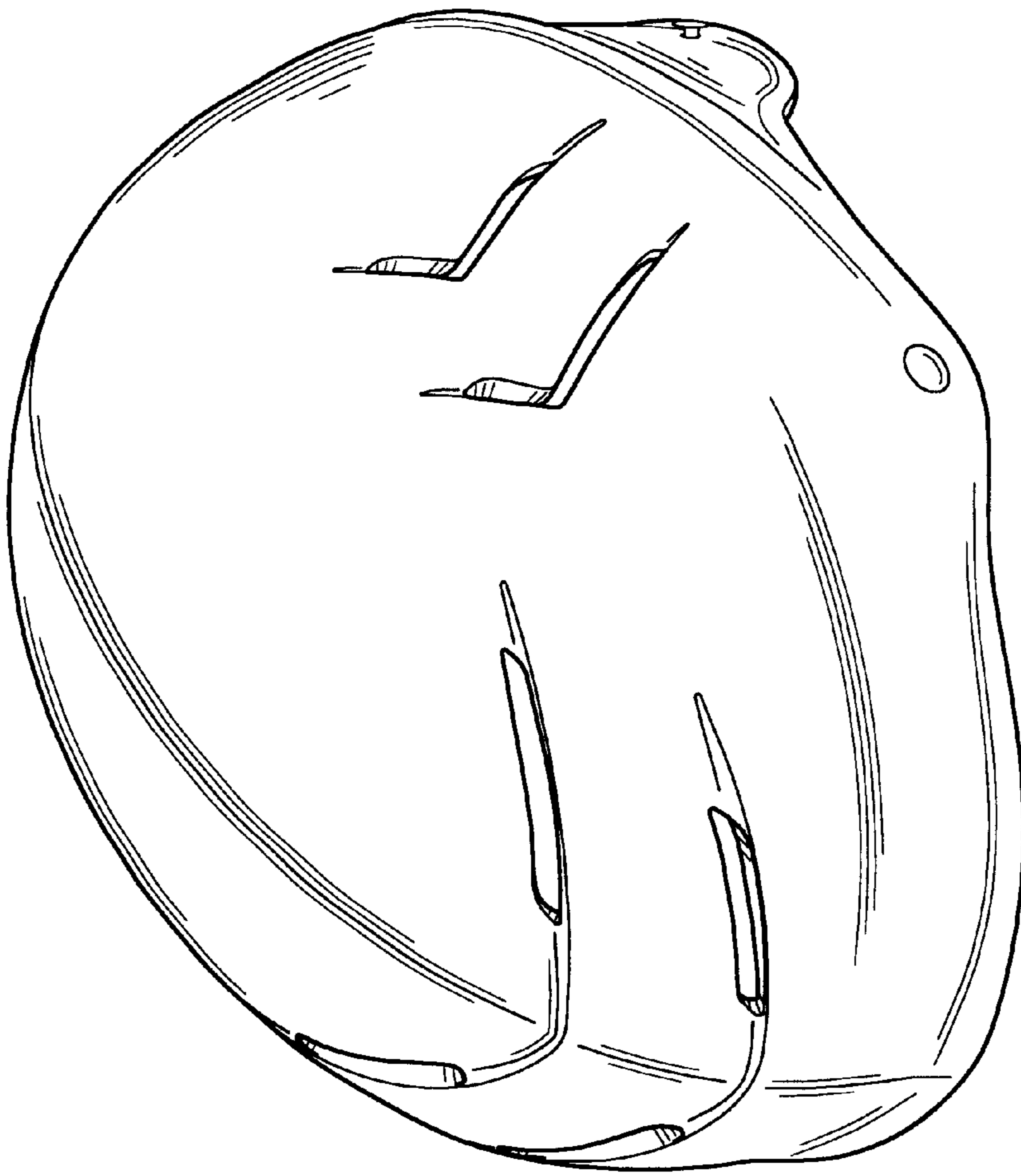

Fig. 1

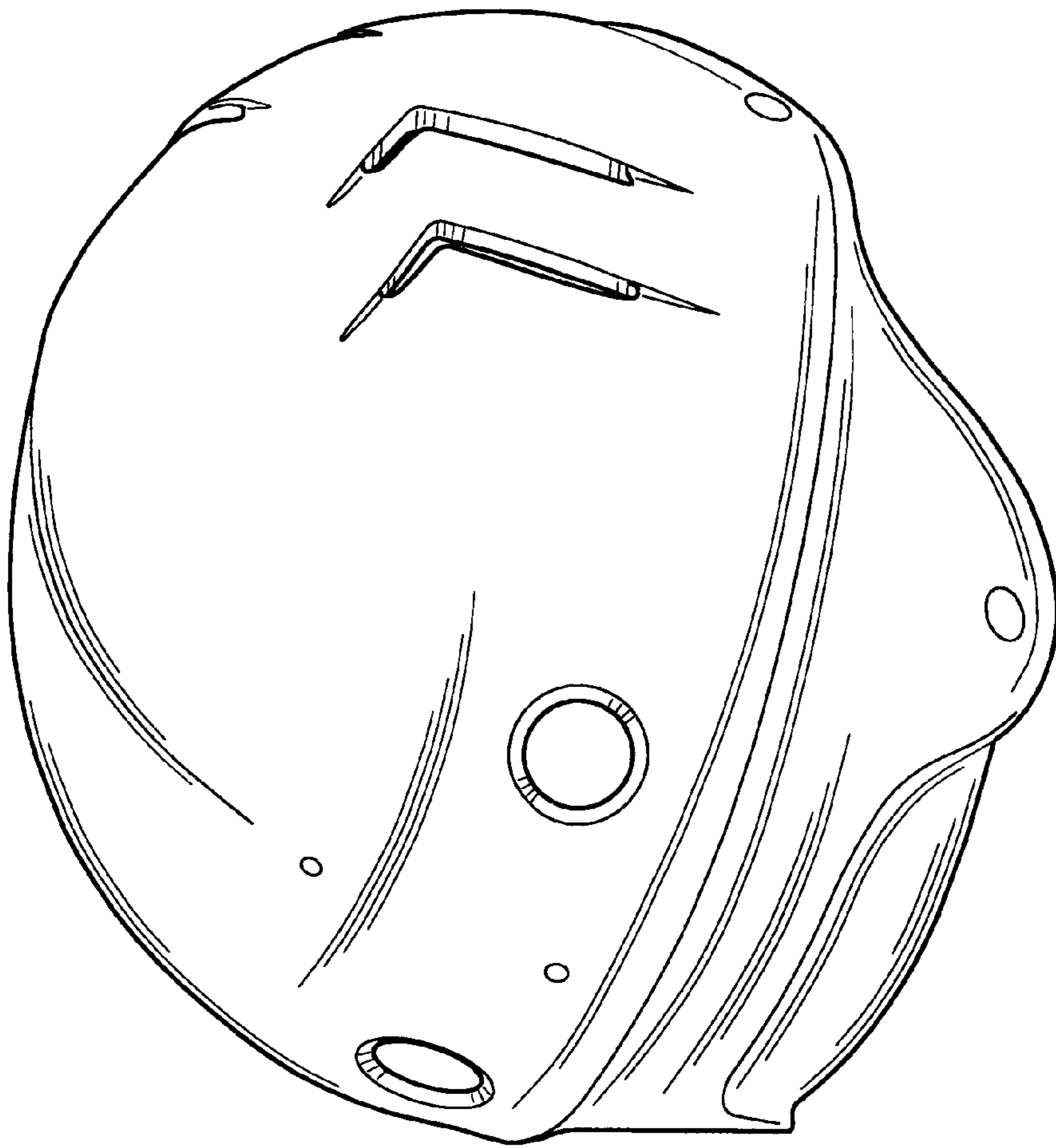

Fig. 2

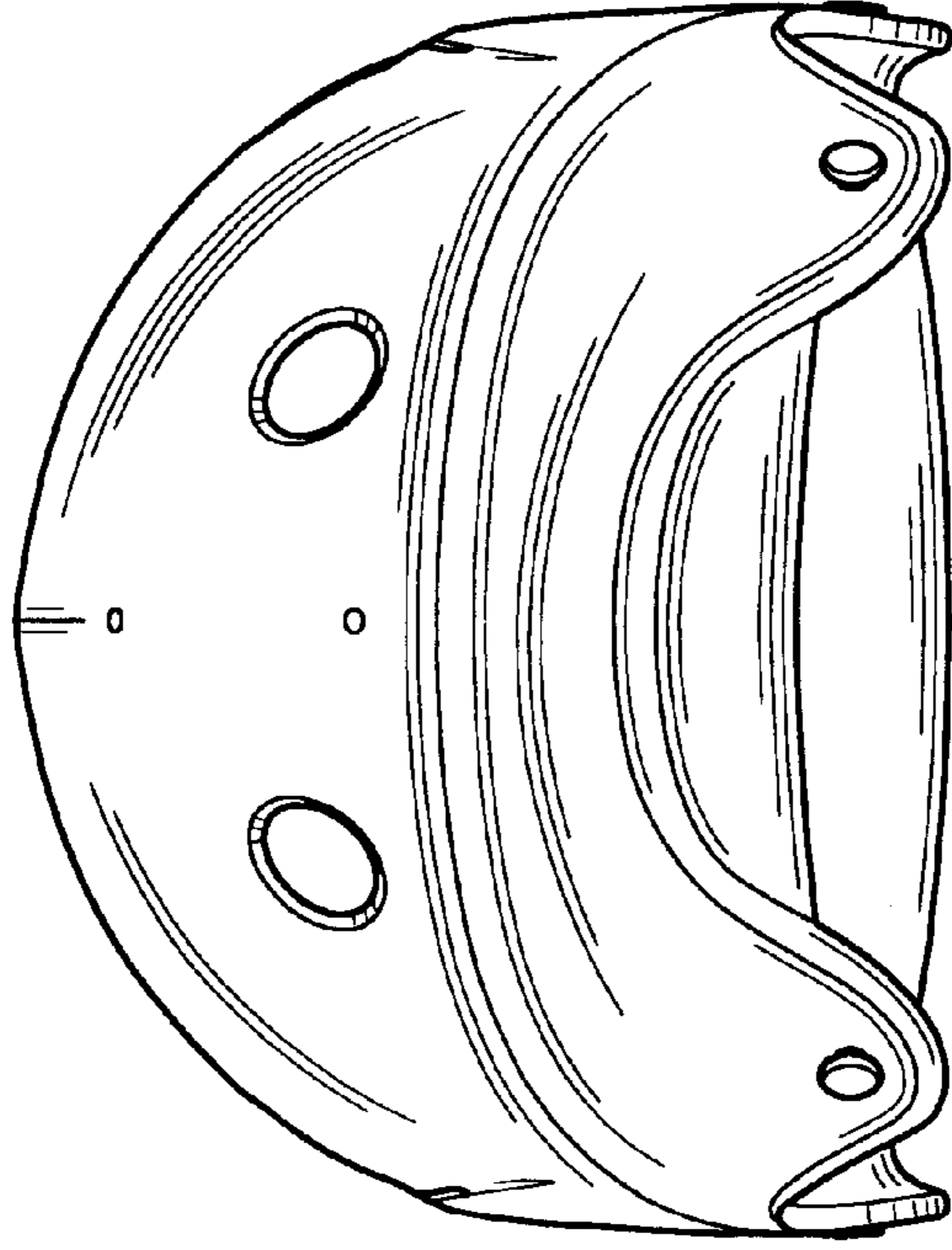

Fig. 3

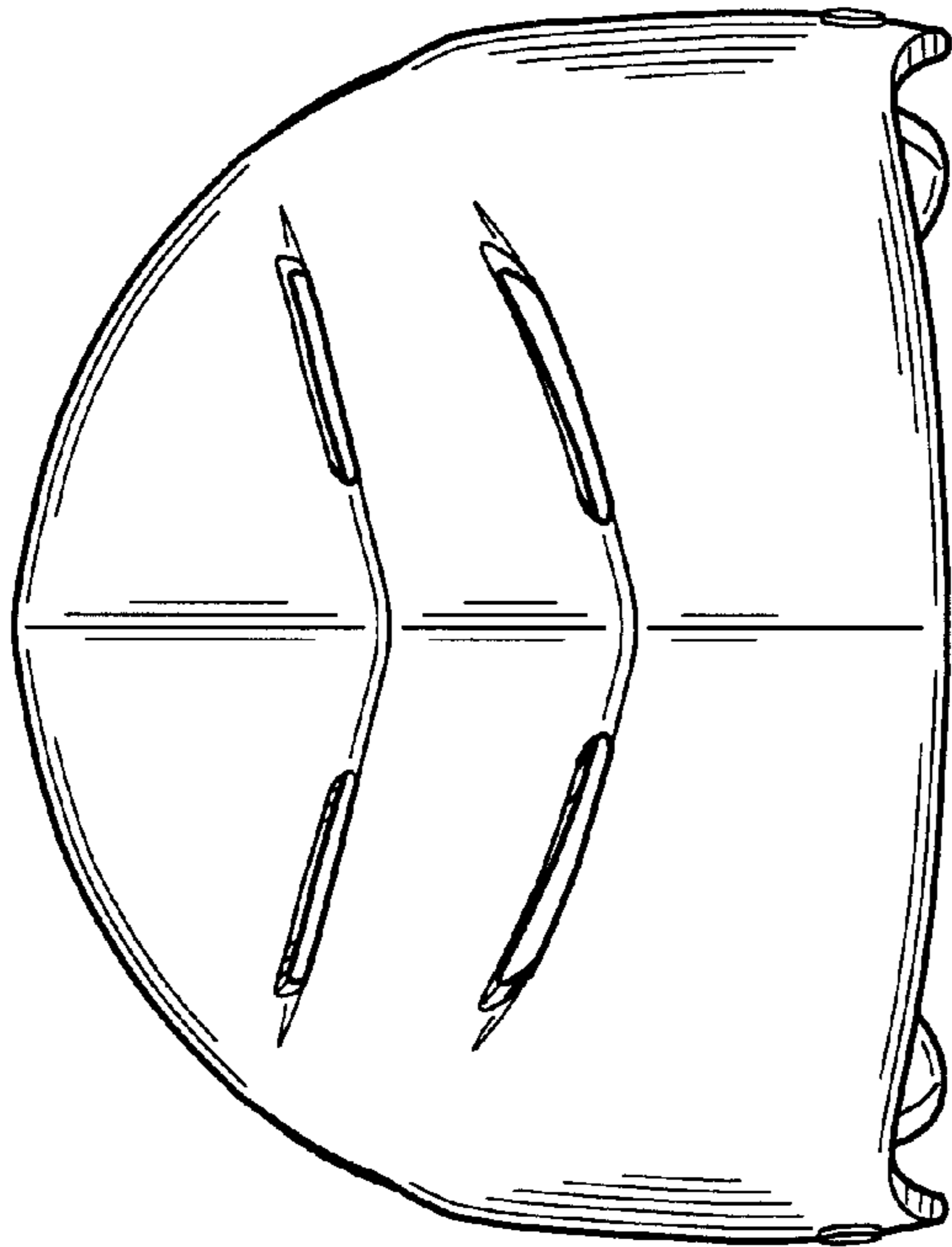

Fig. 4

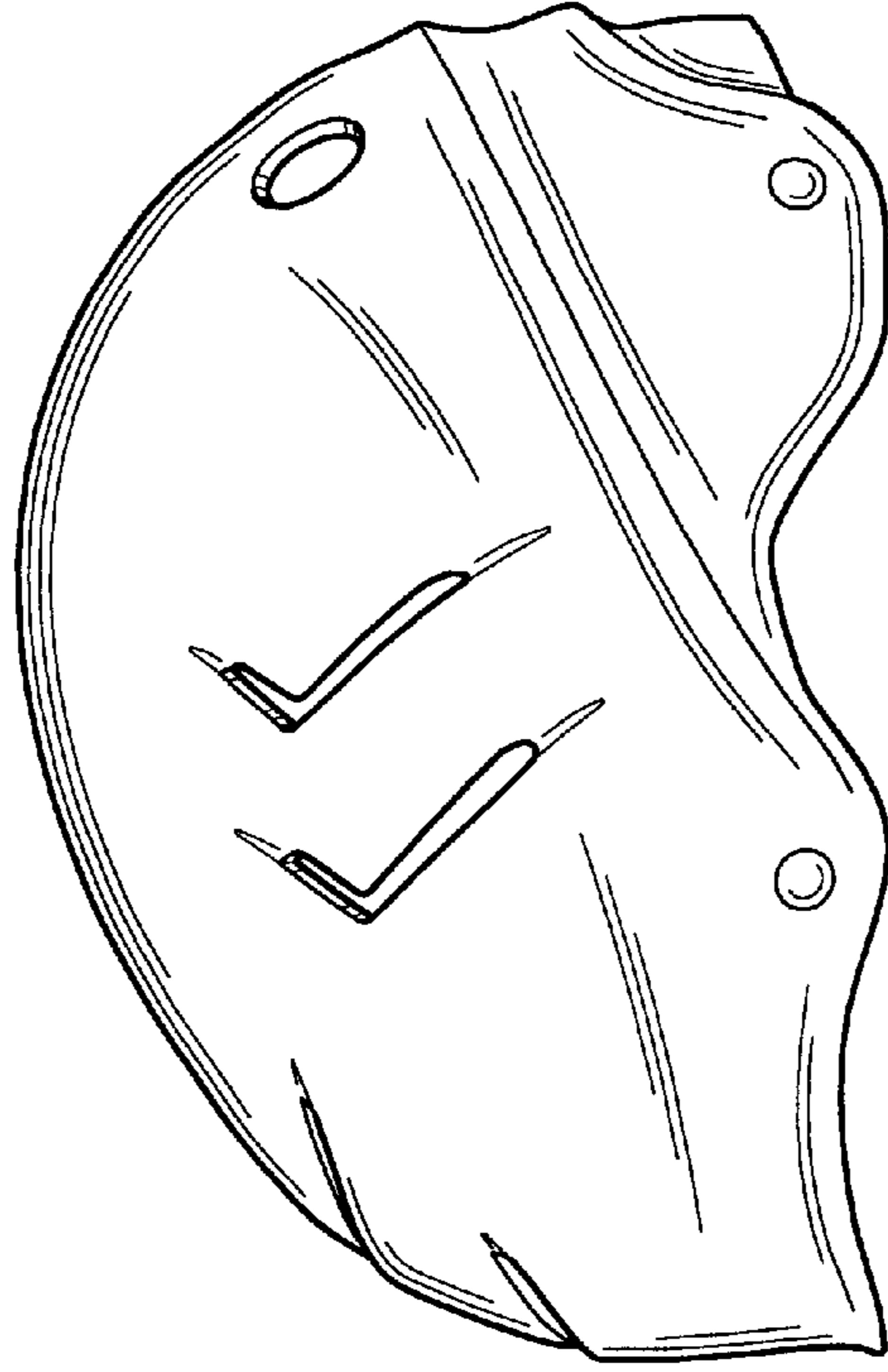

Fig. 5

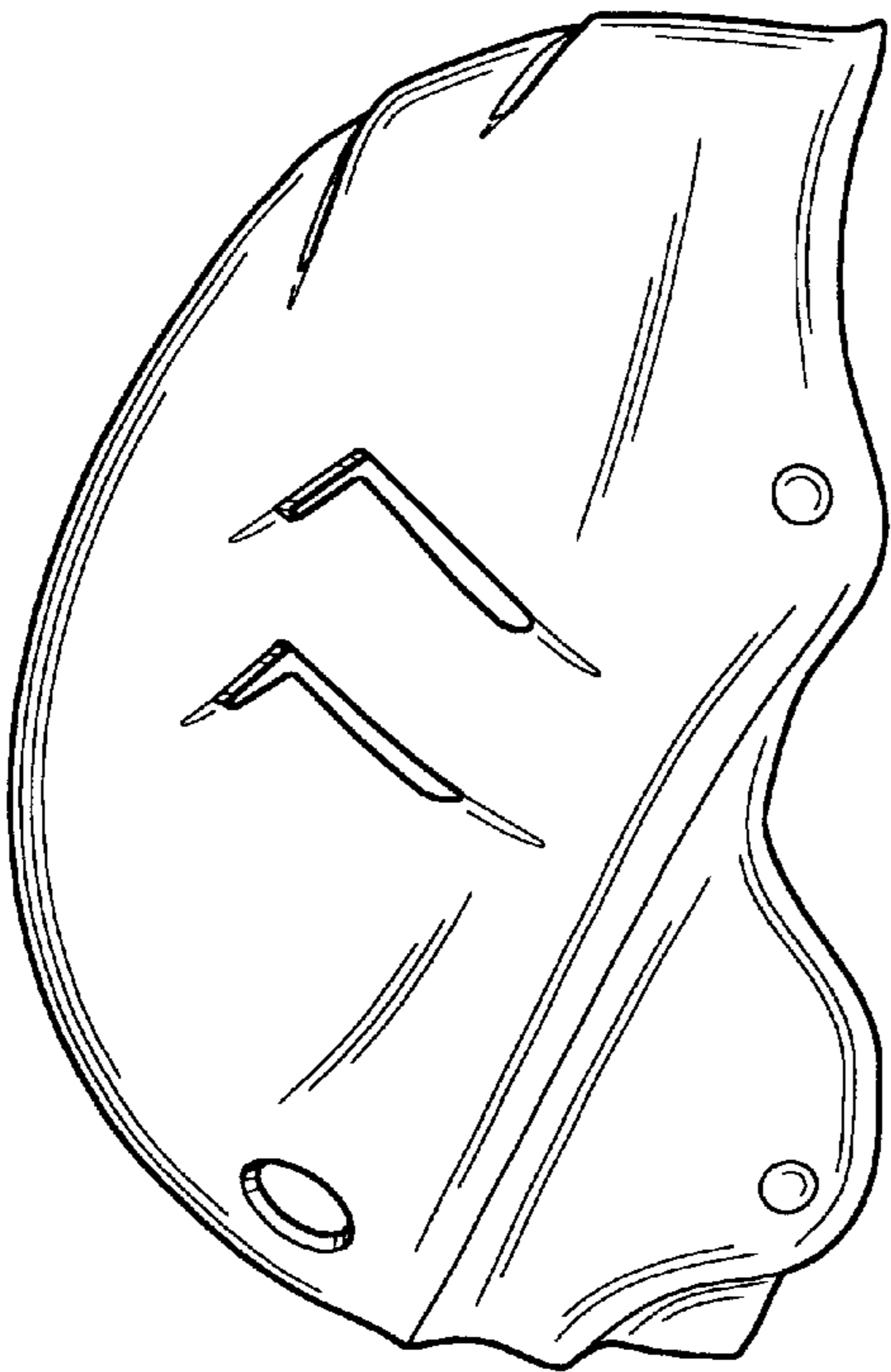

Fig. 6

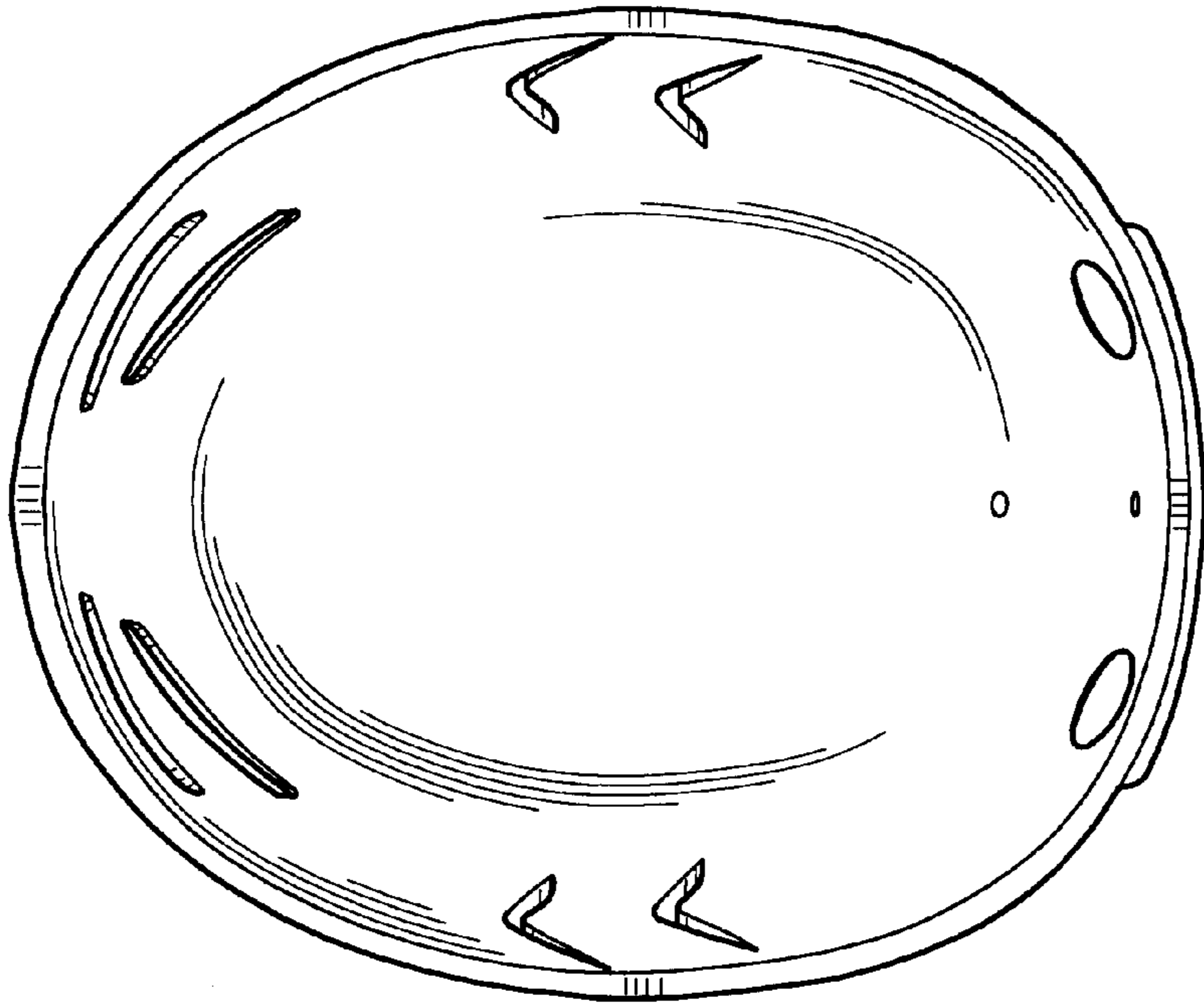

Fig. 8

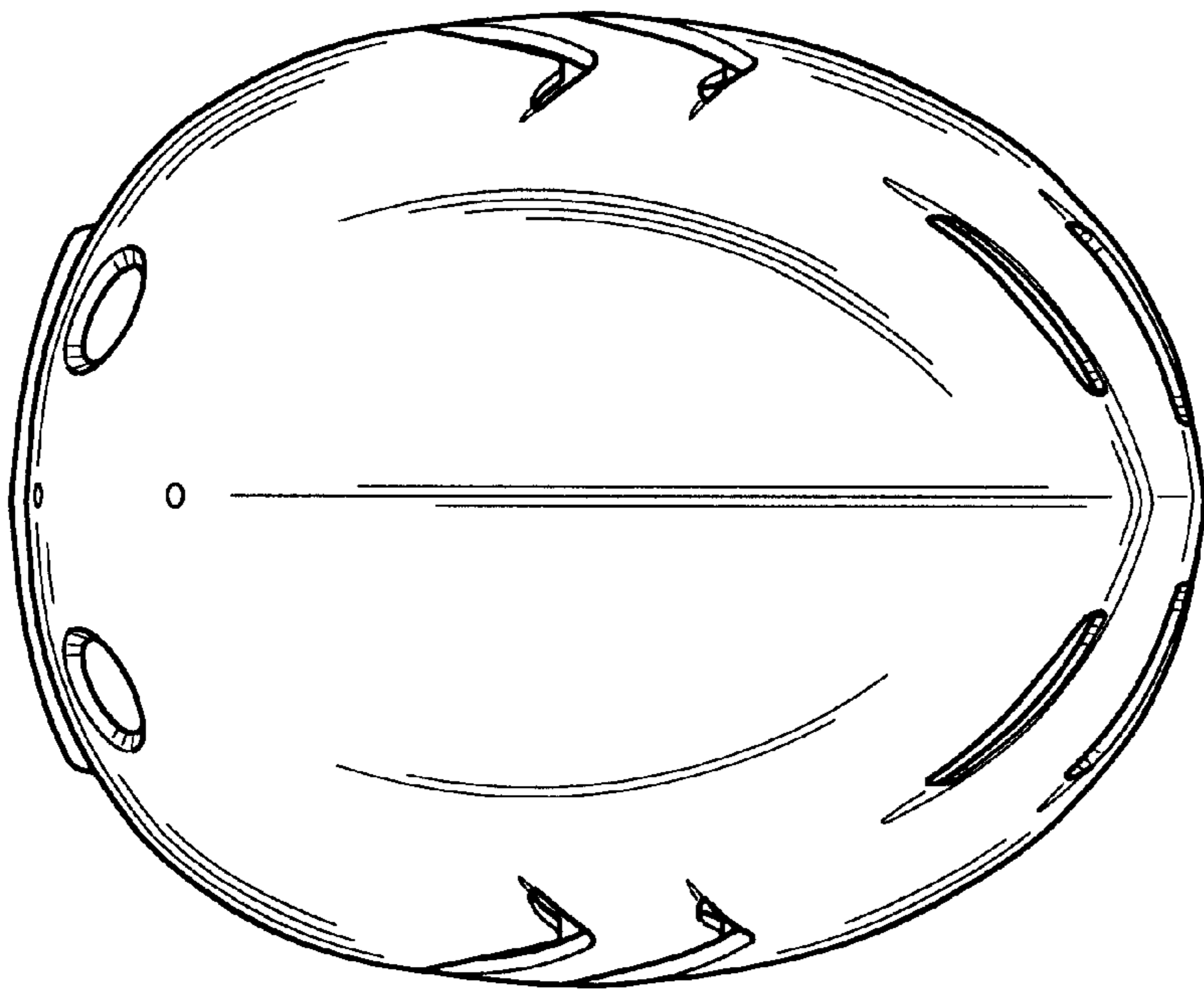

Fig. 7