



US00D447279B1

(12) **United States Design Patent**
Altobellis et al.

(10) **Patent No.:** **US D447,279 S**

(45) **Date of Patent:** **** Aug. 28, 2001**

(54) **LOTION APPLICATOR WITH HINGED HANDLE**

Product packaging (front and back) for Suncare Applicator.

* cited by examiner

(75) Inventors: **Richard M. Altobellis; Douglas K. Ewald**, both of Boulder; **John L. Knight, Jr.**, Vail; **David B. Shaffer**, Lakewood, all of CO (US)

Primary Examiner—Paula A. Mortimer
(74) *Attorney, Agent, or Firm*—Sheridan Ross P.C.

(73) Assignee: **Sunlider, Inc.**, Denver, CO (US)

(57) **CLAIM**

(**) Term: **14 Years**

The ornamental design for a lotion applicator with hinged handle, as shown and described.

(21) Appl. No.: **29/131,974**

(22) Filed: **Oct. 30, 2000**

DESCRIPTION

(51) **LOC (7) Cl.** **28-02**

(52) **U.S. Cl.** **D28/7**

(58) **Field of Search** D28/7, 63; D32/40; D4/121, 137; 206/229; 15/144.1, 144.3, 144.4, 244.1, 244.2, 210.1, 222, 143.1

FIG. 1 is a front perspective view of a lotion applicator with hinged handle showing our new design;

FIG. 2 is a front perspective view of the invention illustrated in FIG. 1, with the handle shown in the folded position;

FIG. 3 is a right end elevation view of the invention illustrated in FIG. 1, the broken lines representing environment and forming no part of the claimed design;

FIG. 4 is a left end elevation view of the invention illustrated in FIG. 1;

FIG. 5 is a top plan view of the invention illustrated in FIG. 1;

FIG. 6 is a bottom plan view of the invention illustrated in FIG. 1, the broken lines representing environment and forming no part of the claimed design;

FIG. 7 is a front elevation view of the invention illustrated in FIG. 1, the broken lines representing environment and forming no part of the claimed design; and,

FIG. 8 is a rear elevation view of the invention illustrated in FIG. 1, the broken lines representing environment and forming no part of the claimed design.

(56) **References Cited**

U.S. PATENT DOCUMENTS

D. 306,214	2/1990	Delphus .	
D. 315,033	2/1991	Carugati .	
D. 337,856	7/1993	Butler et al. .	
D. 366,727	* 1/1996	Possman	D28/7
D. 375,816	* 11/1996	Long-Langworthy	D28/7
D. 384,437	9/1997	Helbock .	
D. 408,944	* 4/1999	Petschow	D28/7
2,860,359	11/1958	James .	
4,381,766	* 5/1983	Avolio	15/143.1
4,659,243	4/1987	Winson .	
5,269,037	12/1993	White .	
5,435,039	* 7/1995	Taylor	15/210.1
5,566,418	10/1996	Steffen et al. .	
5,664,281	* 9/1997	Pelfrey	15/244.2

OTHER PUBLICATIONS

Web page—www.sunmates.com.
Web page—www.sunmates.com/retail.html.
Catalog sheet, item b, Lotion Applicator (SunMates): “As We Change” catalog, source code 0H811.

1 Claim, 2 Drawing Sheets

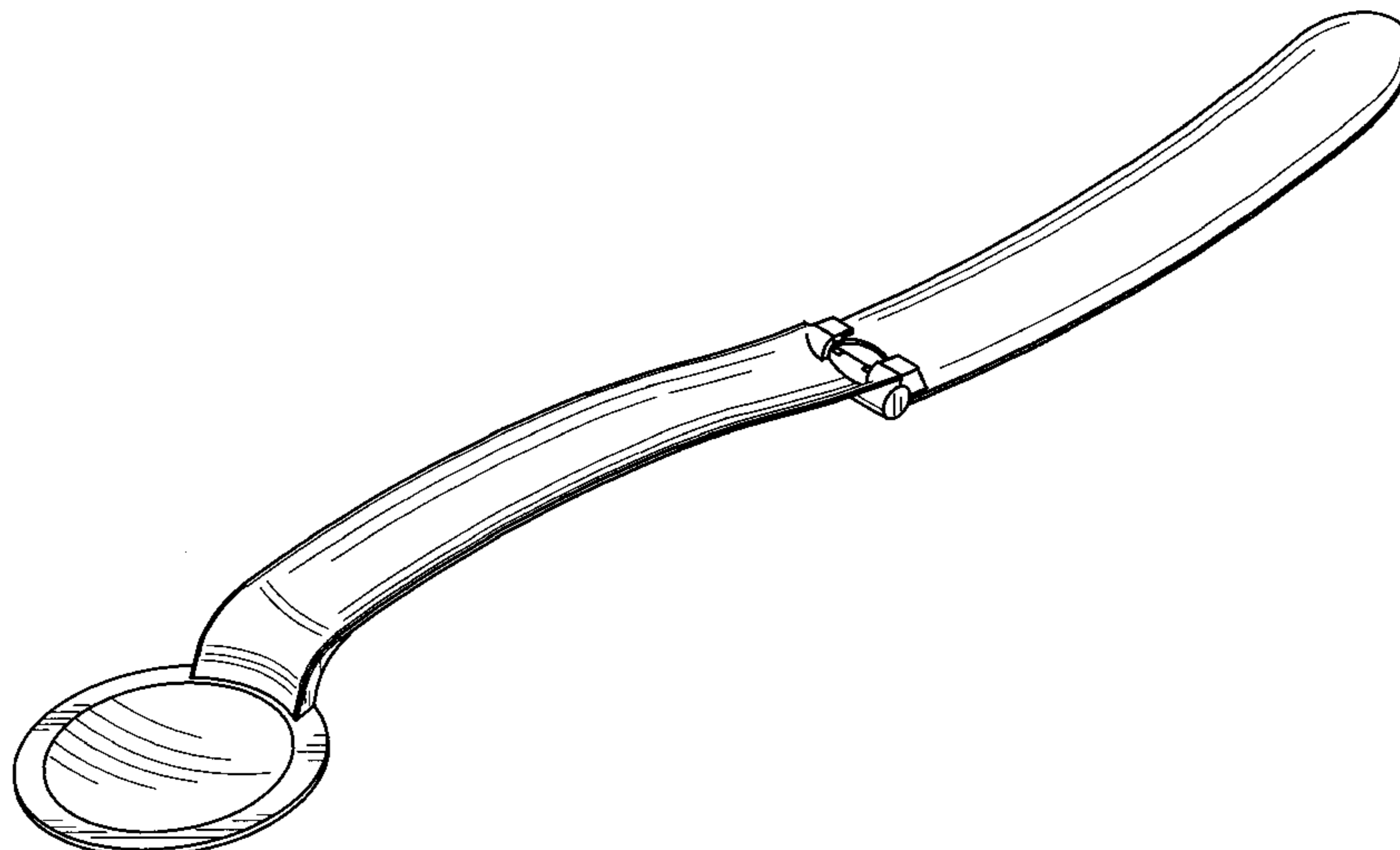

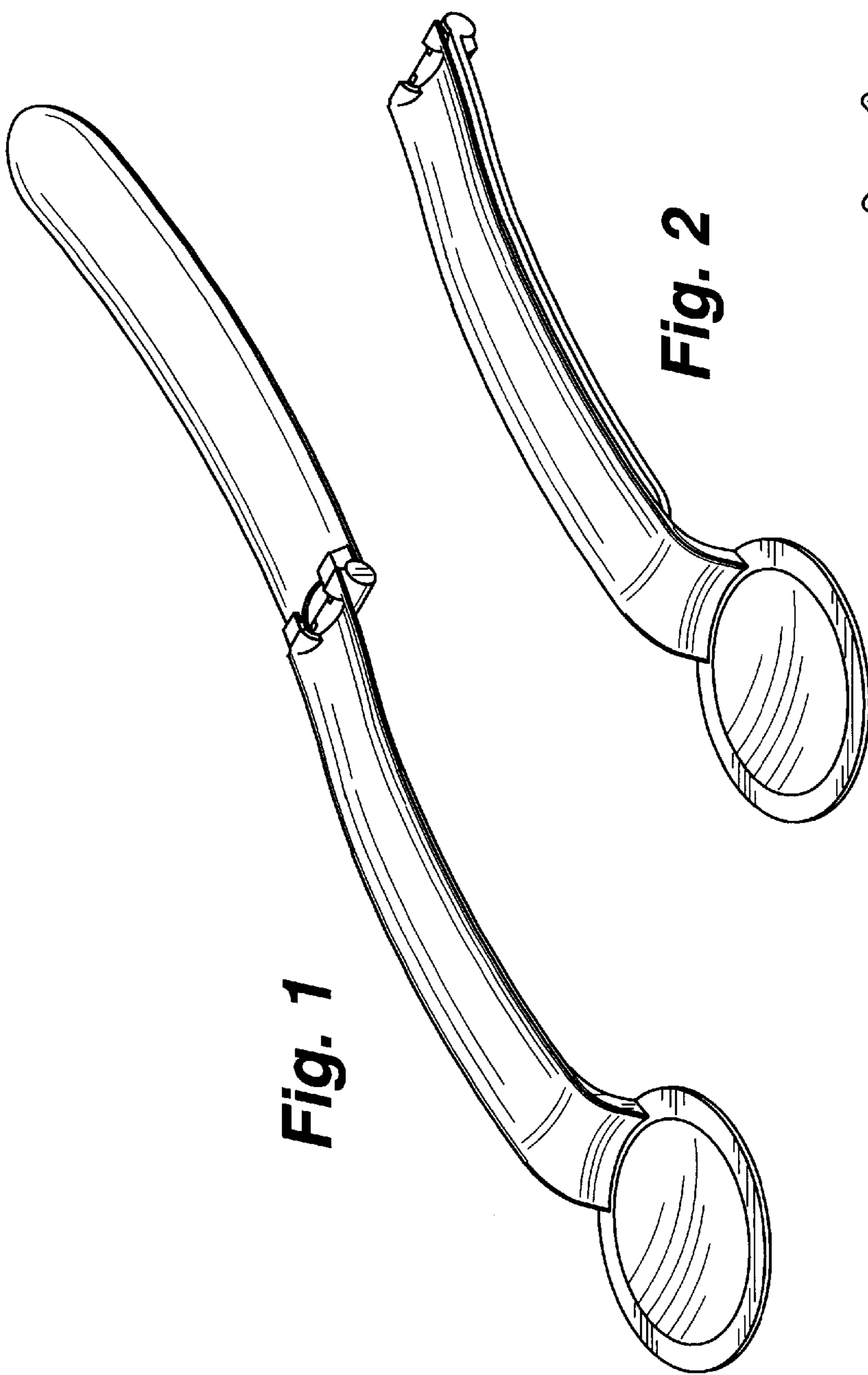

Fig. 2

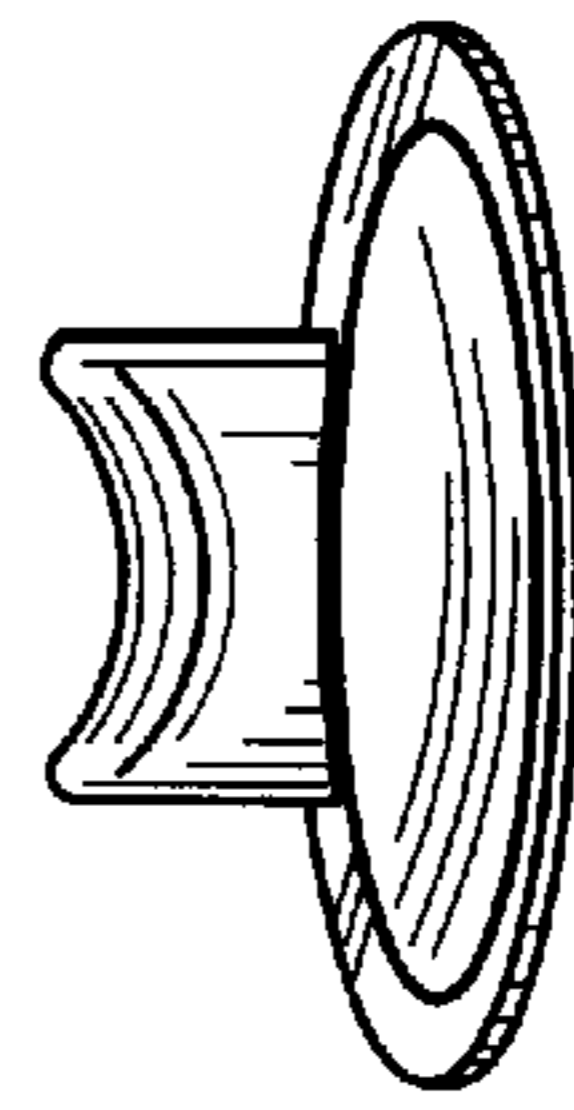

Fig. 4

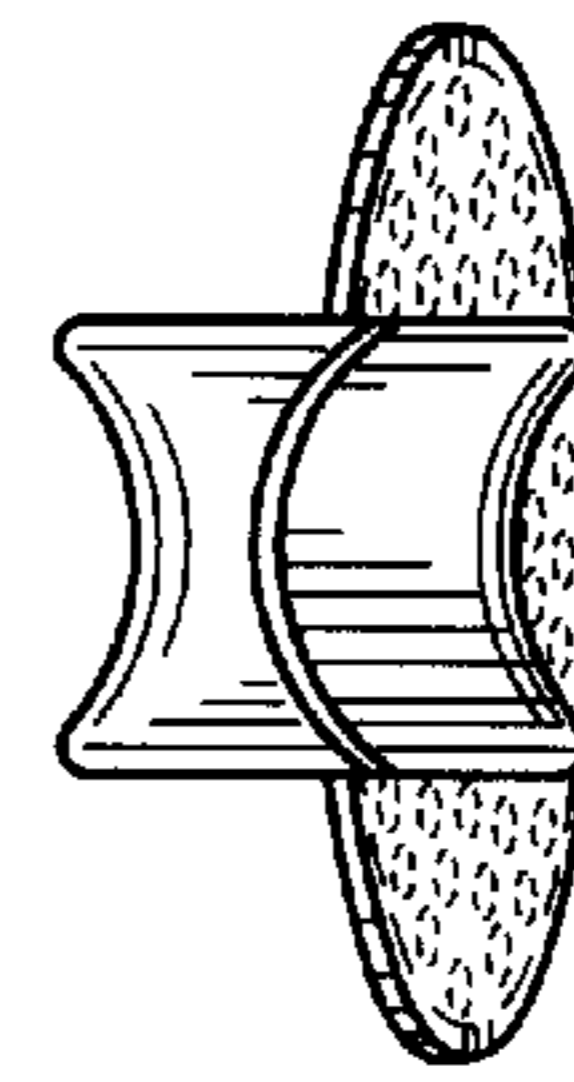

Fig. 5

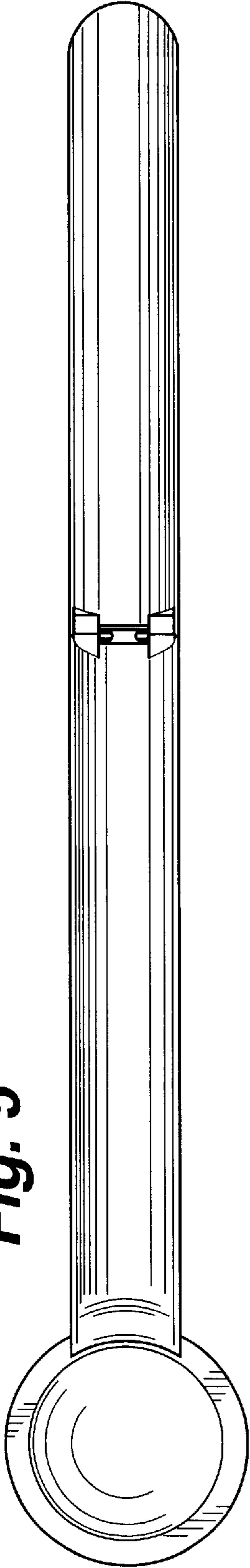

Fig. 6

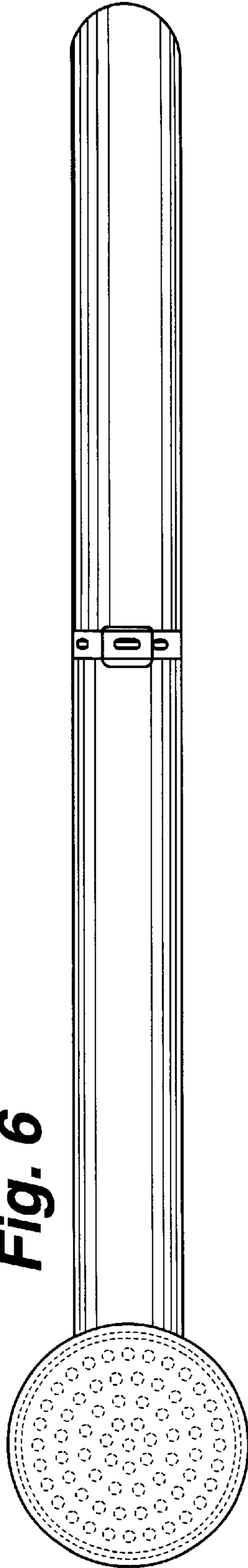

Fig. 7

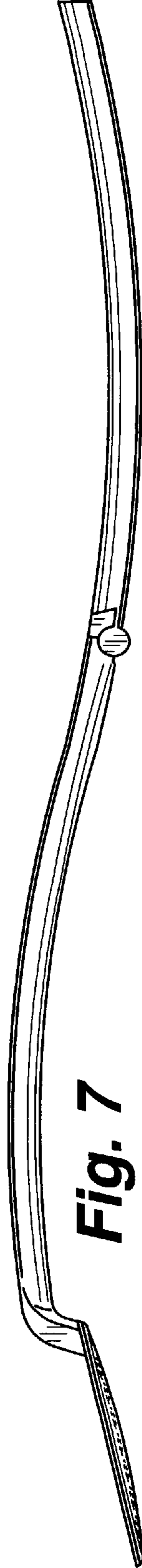

Fig. 8

