



US00D447247B1

(12) **United States Design Patent**  
**Caya**

(10) **Patent No.:** **US D447,247 S**

(45) **Date of Patent:** **\*\* Aug. 28, 2001**

(54) **ROOF OF TELEPHONE BOOTH**

(75) Inventor: **Jacques Caya**, Drummondville (CA)

(73) Assignee: **Industries Jaro Inc.**, St-Charles de Drummond (CA)

(\*\*) Term: **14 Years**

(21) Appl. No.: **29/118,332**

(22) Filed: **Feb. 9, 2000**

(51) **LOC (7) Cl.** ..... **25-02**

(52) **U.S. Cl.** ..... **D25/56**

(58) **Field of Search** ..... D25/16, 17, 56,  
D25/22, 26; 52/27.5

(56) **References Cited**

**U.S. PATENT DOCUMENTS**

1,382,265 \* 6/1921 Beeby ..... 52/27.5

\* cited by examiner

*Primary Examiner*—Doris Clark

(74) *Attorney, Agent, or Firm*—Robic

(57) **CLAIM**

The ornamental design for a roof of telephone booth, as shown and described.

**DESCRIPTION**

FIG. 1 is a front perspective view of a roof of telephone booth showing my new design;

FIG. 2 is a front perspective view of a second embodiment of the roof of telephone booth shown in FIG. 1;

FIG. 3 is a top plan view of the design as shown in FIG. 1, at an enlarged scale, the top plan view of the second embodiment being substantially the same;

FIG. 4 is a front elevational view of the second embodiment shown in FIG. 2;

FIG. 5 is a perspective view of a telephone booth incorporating the roof of telephone booth shown in FIGS. 1 and 3; and,

FIG. 6 is a perspective view similar to FIG. 5 but incorporating the second embodiment of the roof of telephone booth shown in FIGS. 2 to 4.

The broken lines are for illustrative purposes only and form no part of the claimed design.

**1 Claim, 6 Drawing Sheets**

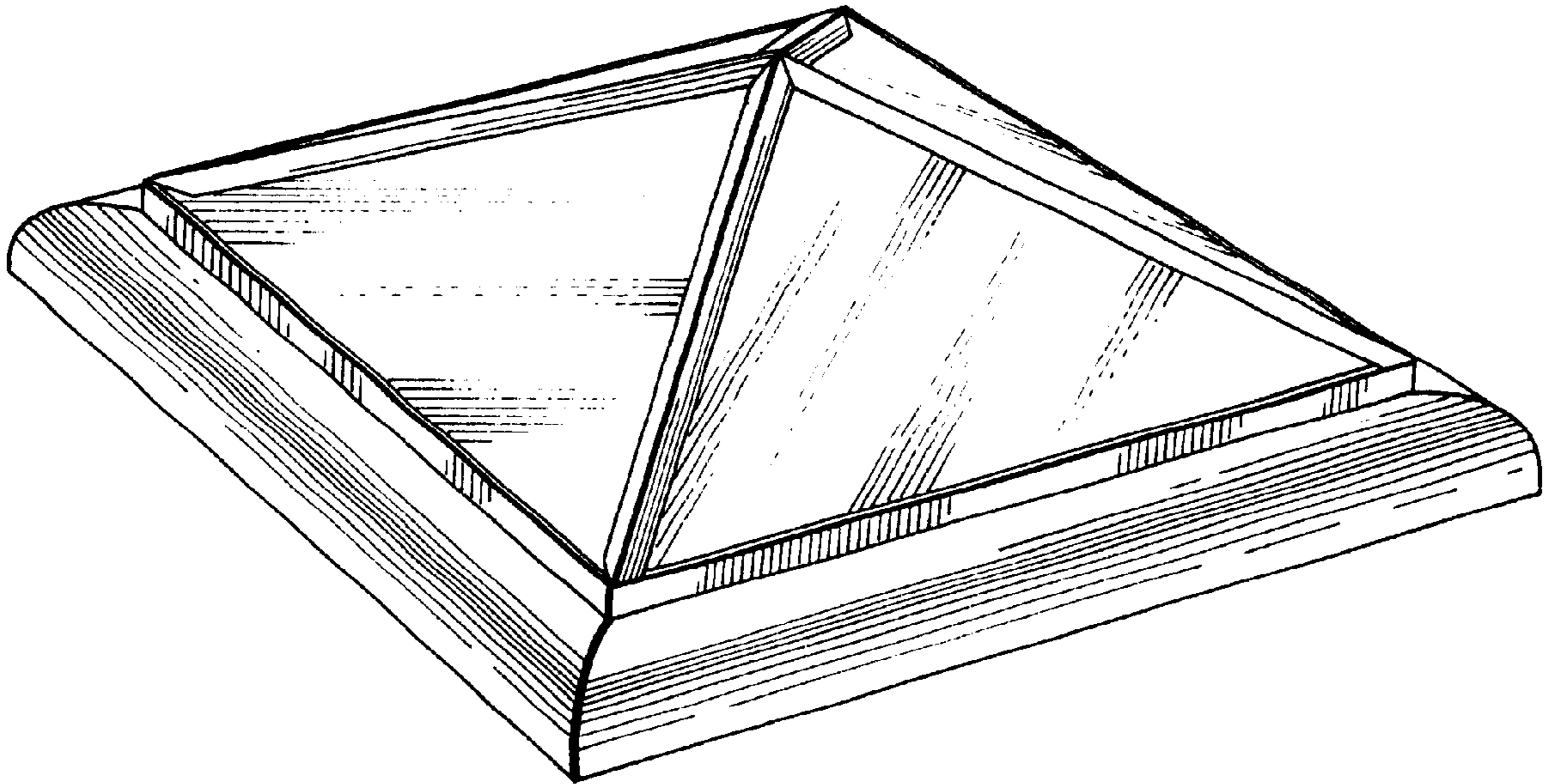

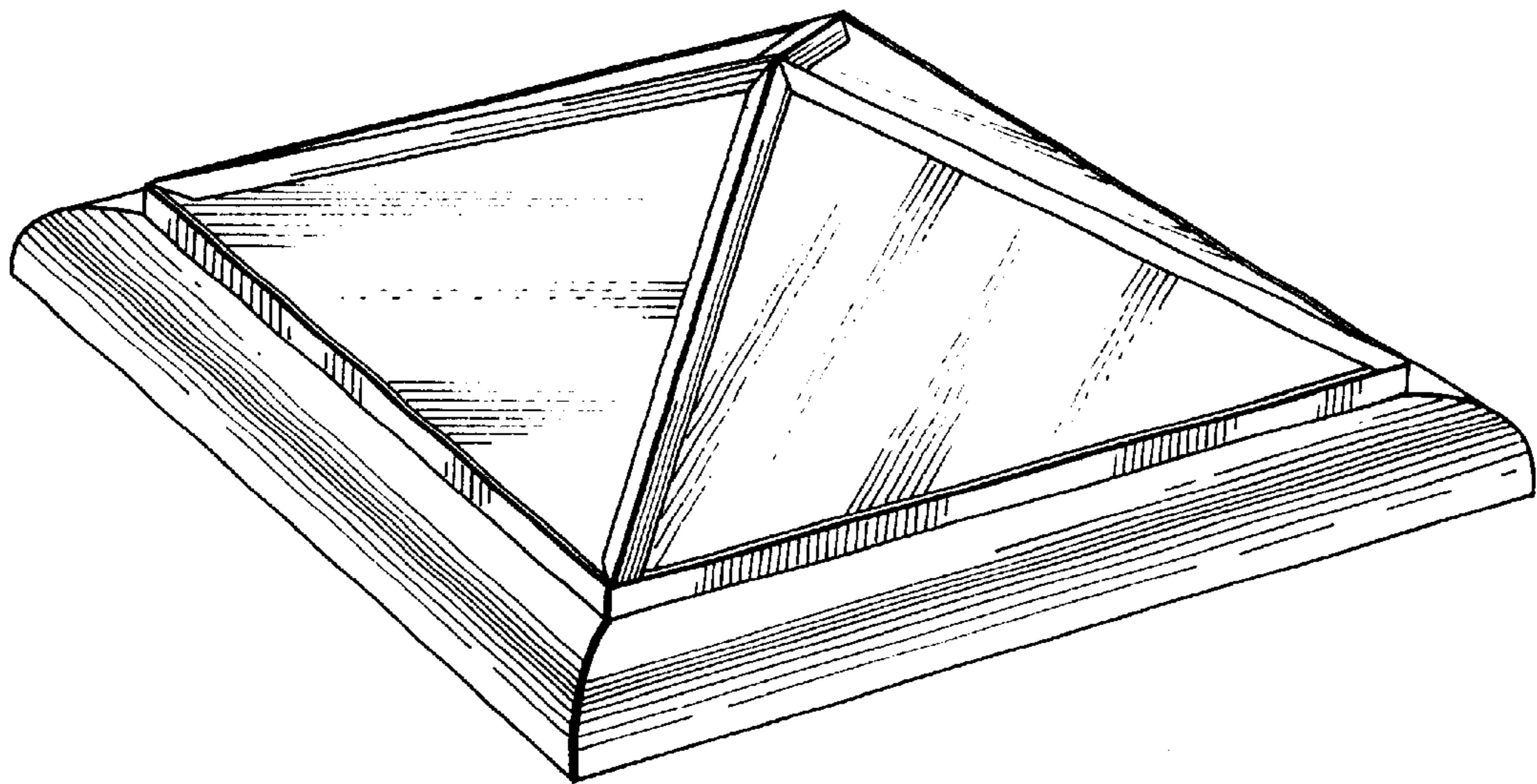

FIG. 1

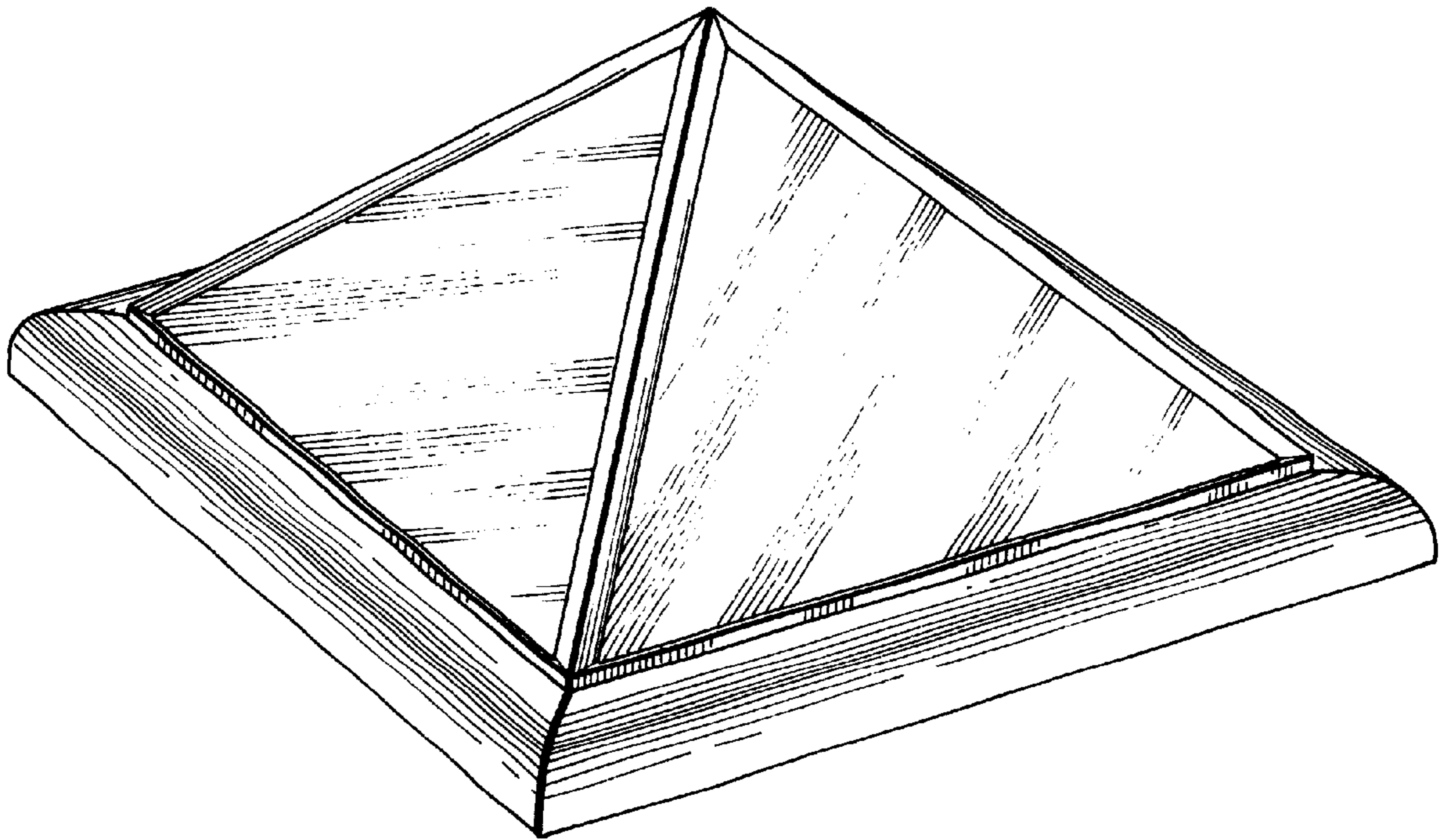

FIG. 2

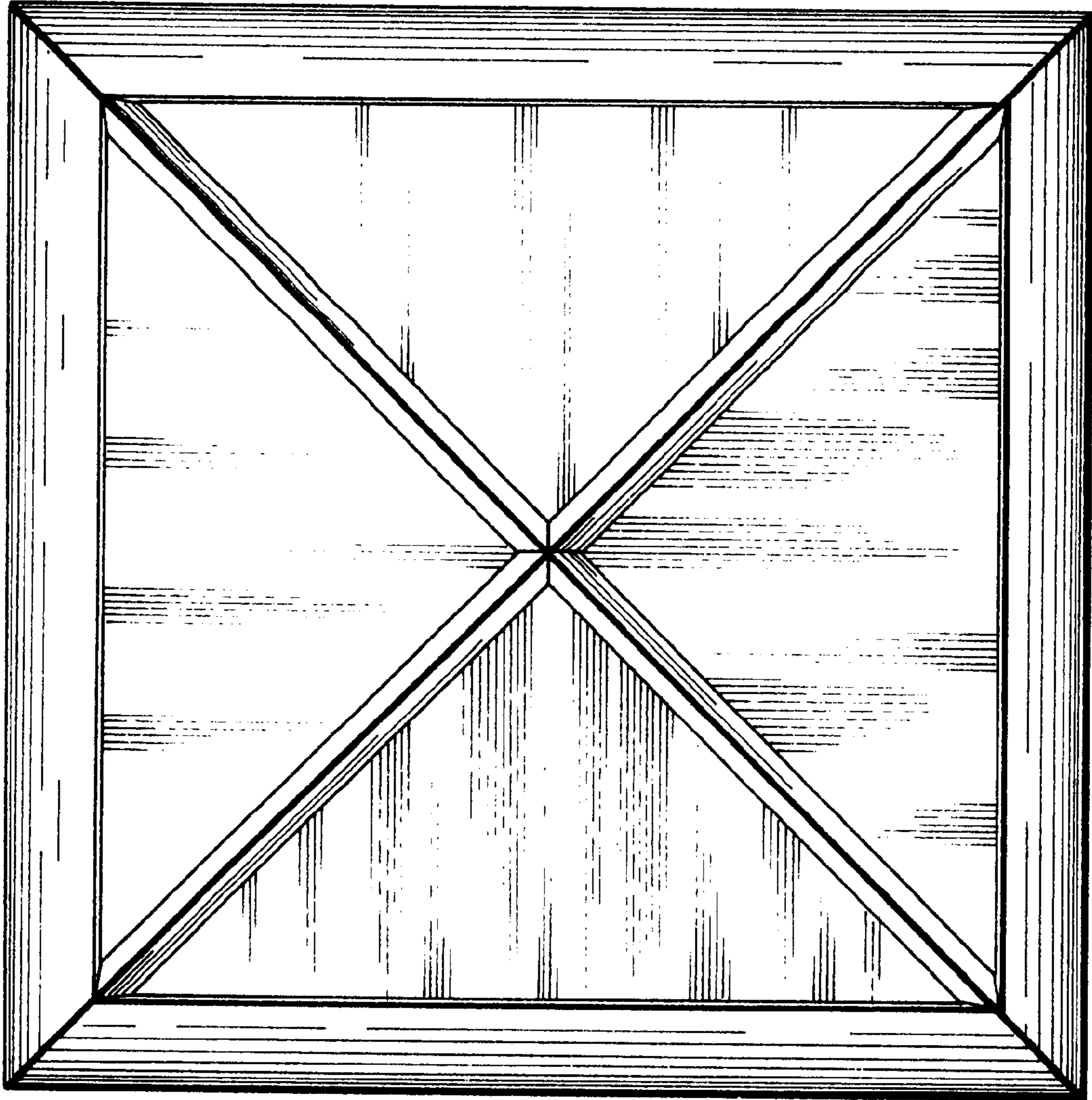

FIG. 3

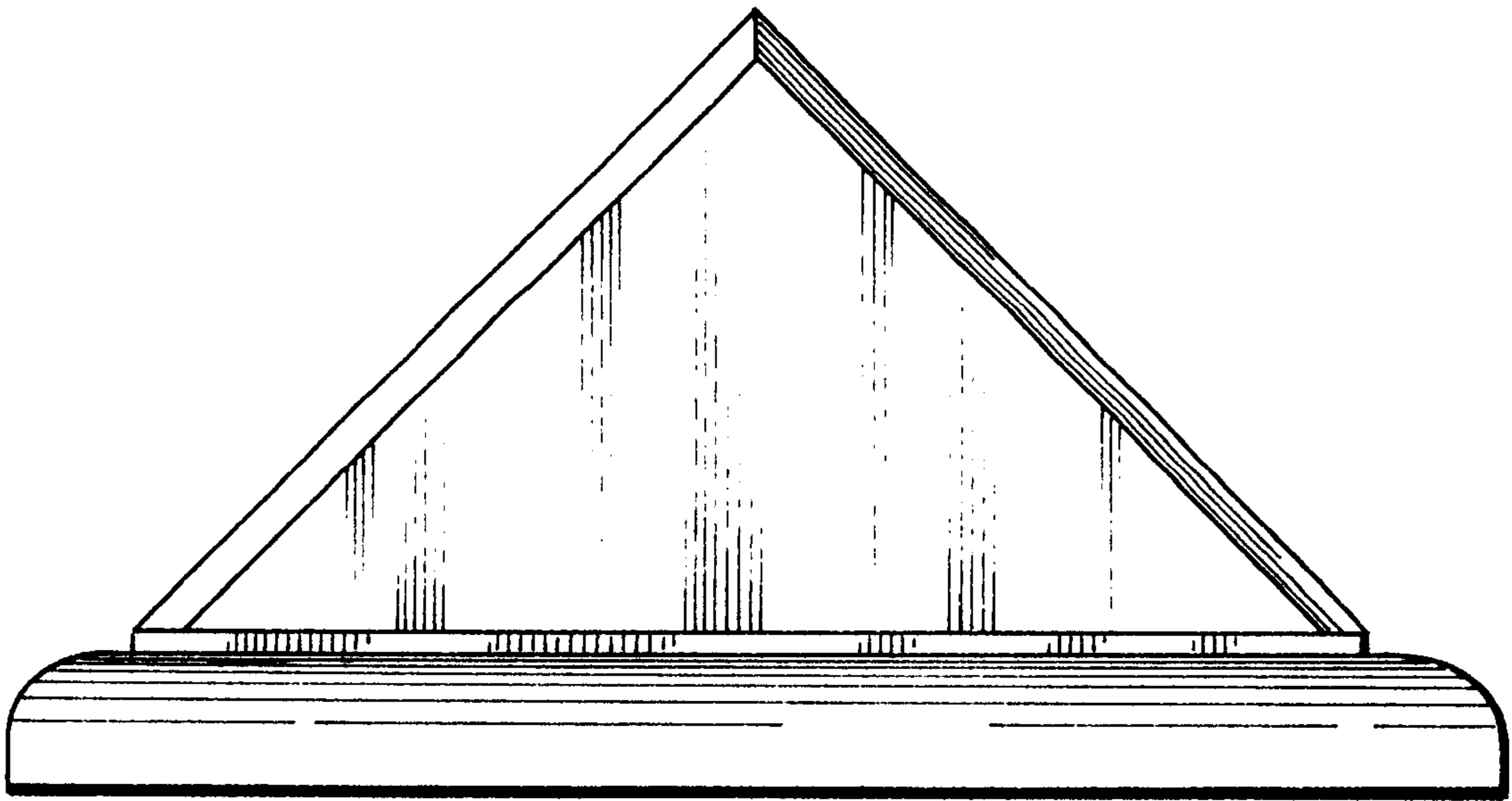

FIG. 4

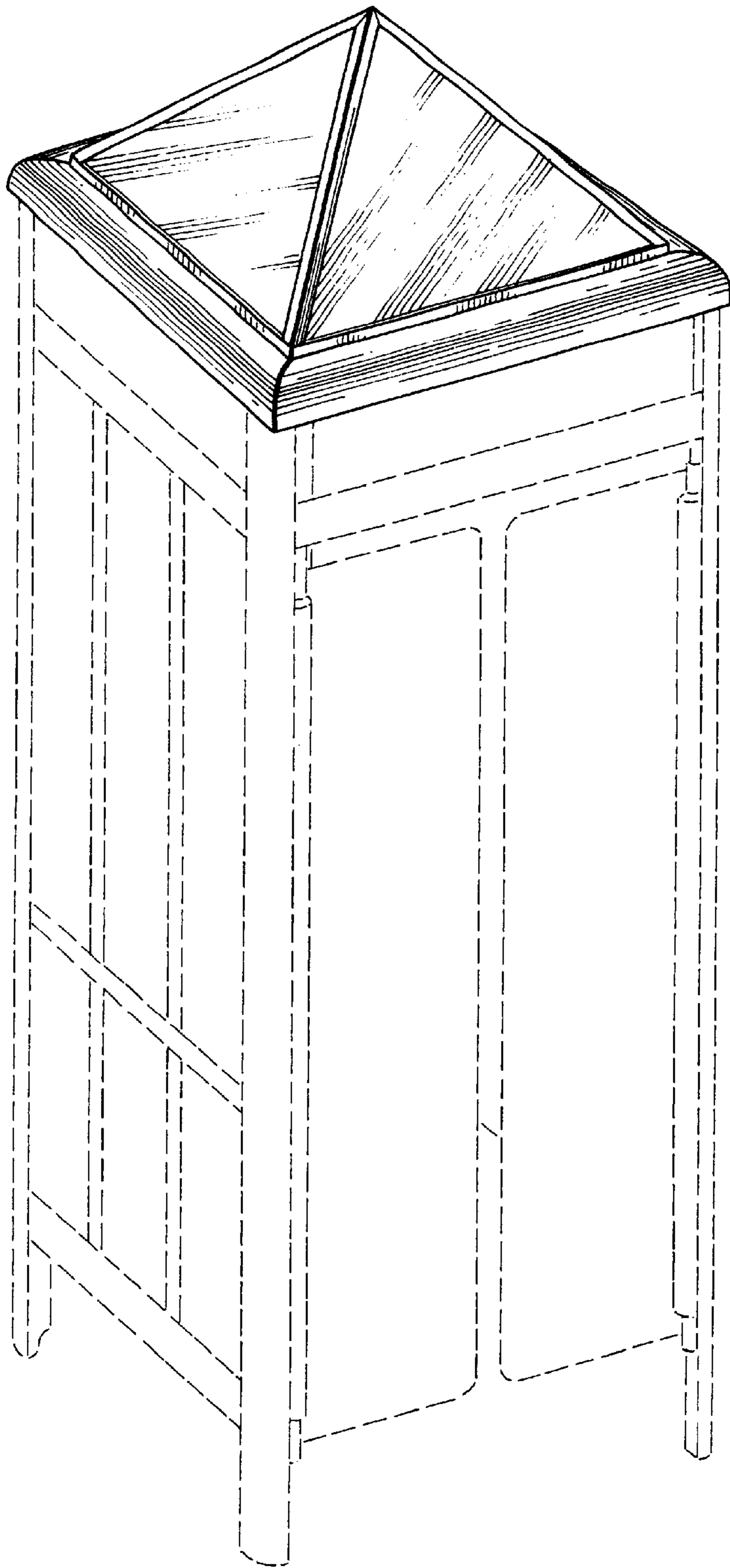

FIG. 5

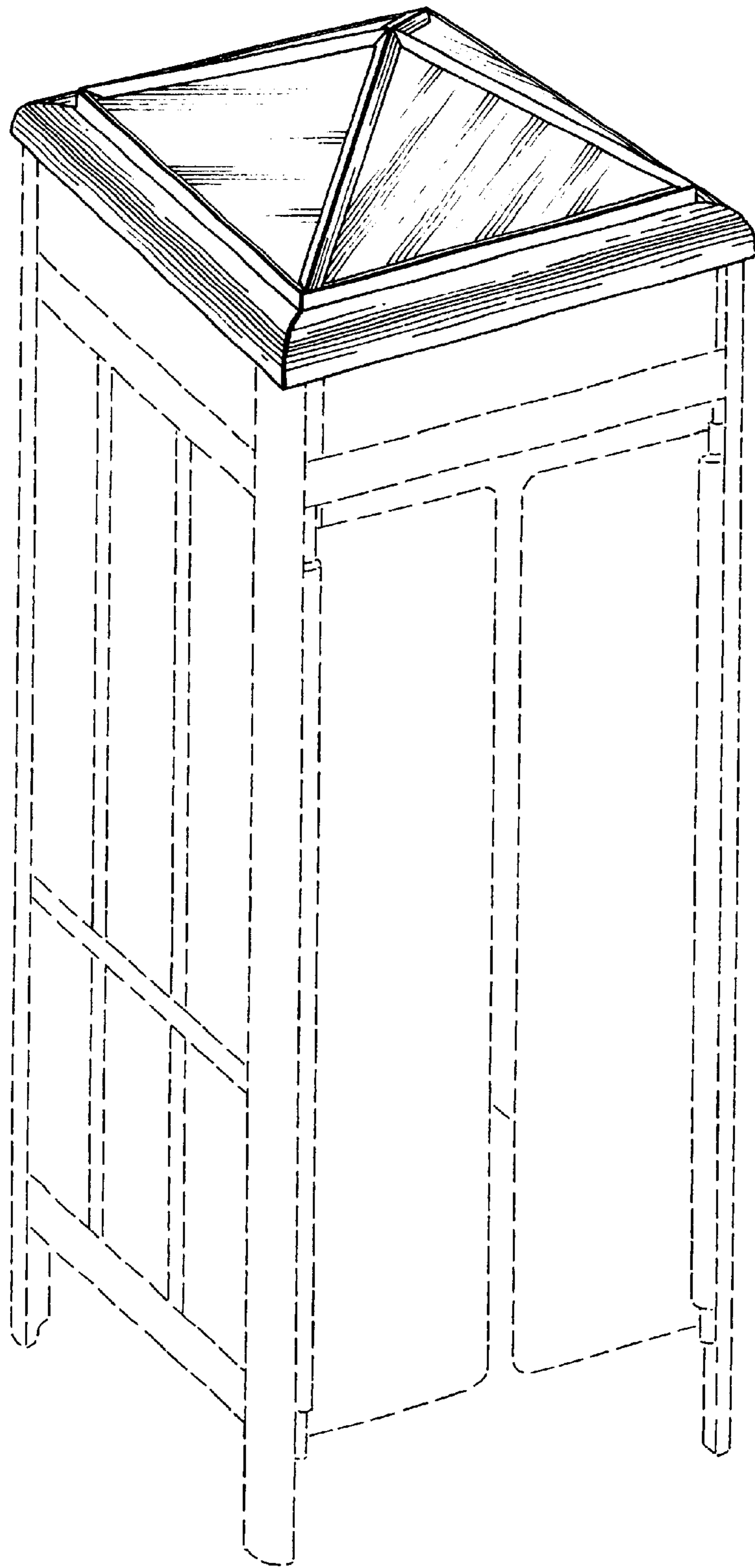

FIG. 6