



US00D447230B1

(12) **United States Design Patent**
Matsugi et al.

(10) **Patent No.:** **US D447,230 S**

(45) **Date of Patent:** **** Aug. 28, 2001**

(54) **CONTAINER WITH DISPENSING MEANS**

(75) Inventors: **Hideo Matsugi; Yuji Makino;**
Masahiko Dohi; Yasuhide Uejima, all
of Hino (JP)

(73) Assignee: **Teijin Limited**, Osaka (JP)

(**) Term: **14 Years**

(21) Appl. No.: **29/126,490**

(22) Filed: **Jul. 19, 2000**

(51) **LOC (7) Cl.** **29-02**

(52) **U.S. Cl.** **D24/110**

(58) **Field of Search** D24/110, 115,
D24/121; 128/203.15, 203.12, 203.23, 200,
14, 200.23, 203.18, 200.18

(56) **References Cited**

U.S. PATENT DOCUMENTS

D. 350,193	*	8/1994	Huck et al.	D24/110
D. 359,555	*	6/1995	Funai et al.	D24/110
D. 395,706	*	6/1998	Minshull	D24/110
2,670,739	*	3/1954	McNeill	128/200.18
4,116,195	*	9/1978	James	128/203.21

FOREIGN PATENT DOCUMENTS

11-24264		9/1999	(JP)	.
WO 00/41755		7/2000	(WO)	.

* cited by examiner

Primary Examiner—Ian Simmons

(74) *Attorney, Agent, or Firm*—Sughrue, Mion, Zinn,
Macpeak & Seas, PLLC

(57) **CLAIM**

The ornamental design for a container with dispensing means, as shown and described.

DESCRIPTION

FIG. 1 is a left, front, top perspective view of a container with dispensing means with its cap in a closed position, showing our new design;

FIG. 2 is a front elevational view of FIG. 1;

FIG. 3 is a rear elevational view of FIG. 1;

FIG. 4 is a left side elevational view of FIG. 1;

FIG. 5 is a right side elevational view of FIG. 1;

FIG. 6 is a top plan view of FIG. 1;

FIG. 7 is a bottom view of FIG. 1;

FIG. 8 is a left, front, top perspective view of the container with dispensing means with its cap in an exploded position;

FIG. 9 is a front elevational view of FIG. 8;

FIG. 10 is a rear elevational view of FIG. 8;

FIG. 11 is a left side elevational view of FIG. 8;

FIG. 12 is a right side elevational view of FIG. 8;

FIG. 13 is a top plan view of the container with dispensing means with the cap removed; and,

FIG. 14 is a bottom plan view of the cap of the container with dispensing means.

1 Claim, 5 Drawing Sheets

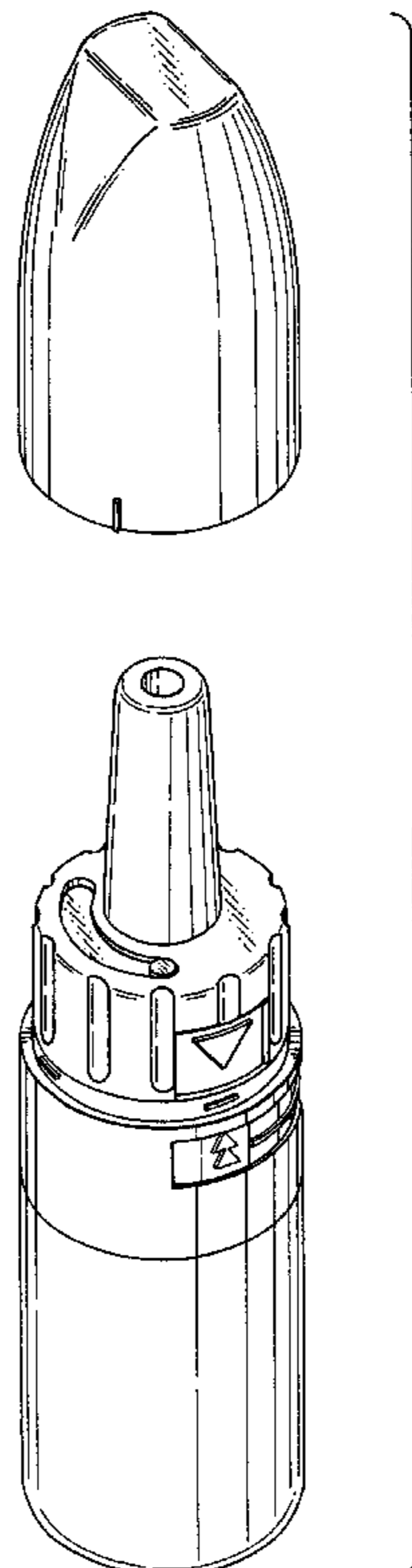

Fig.1

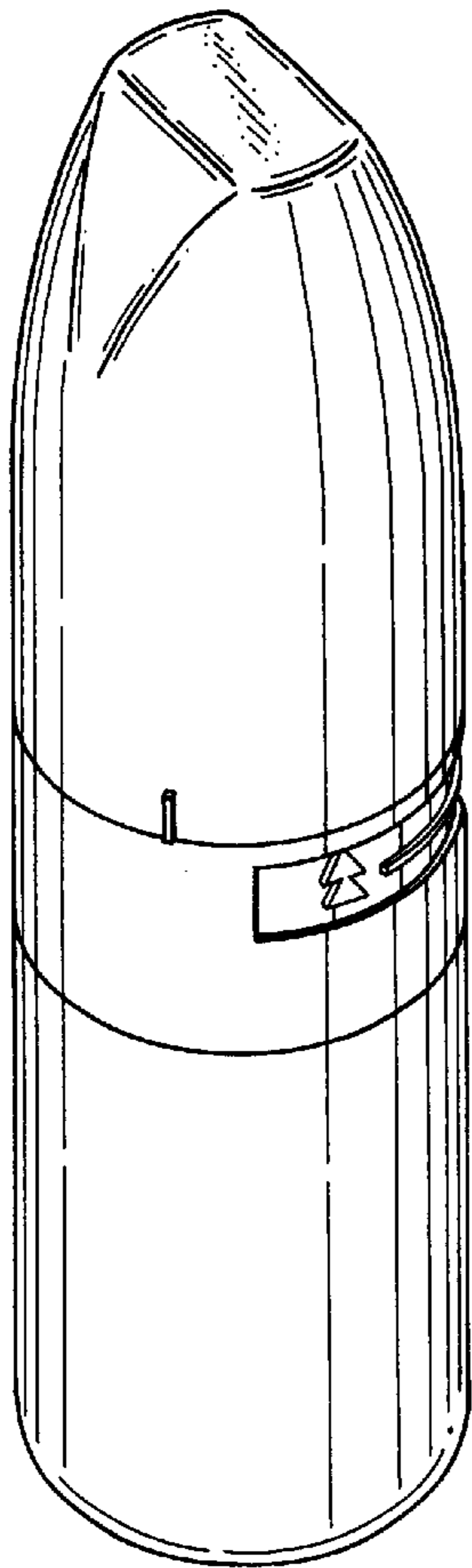

Fig.2

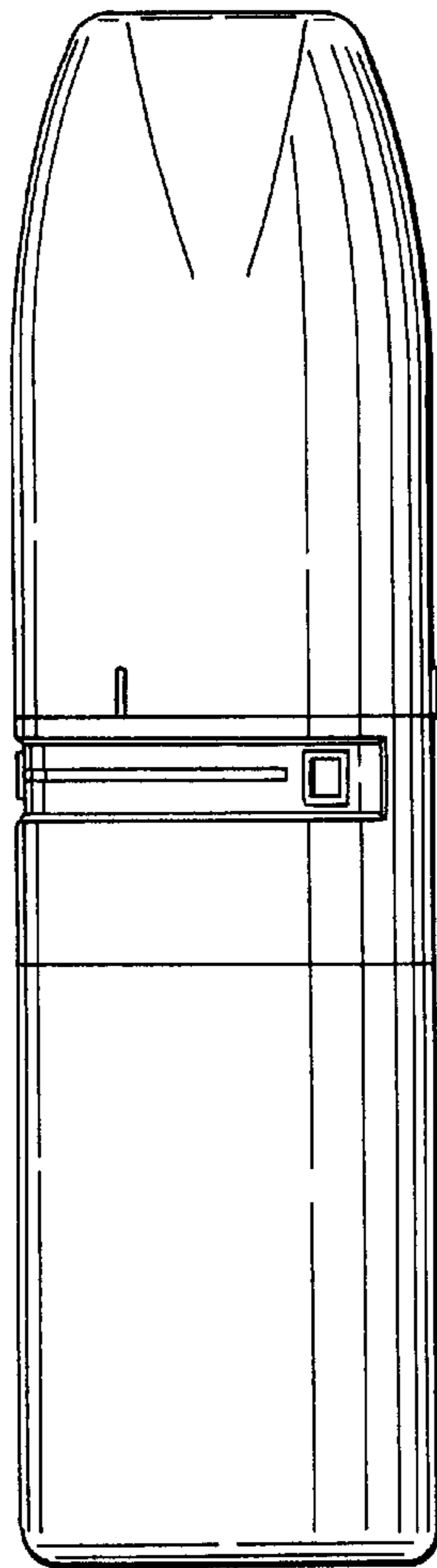

Fig.3

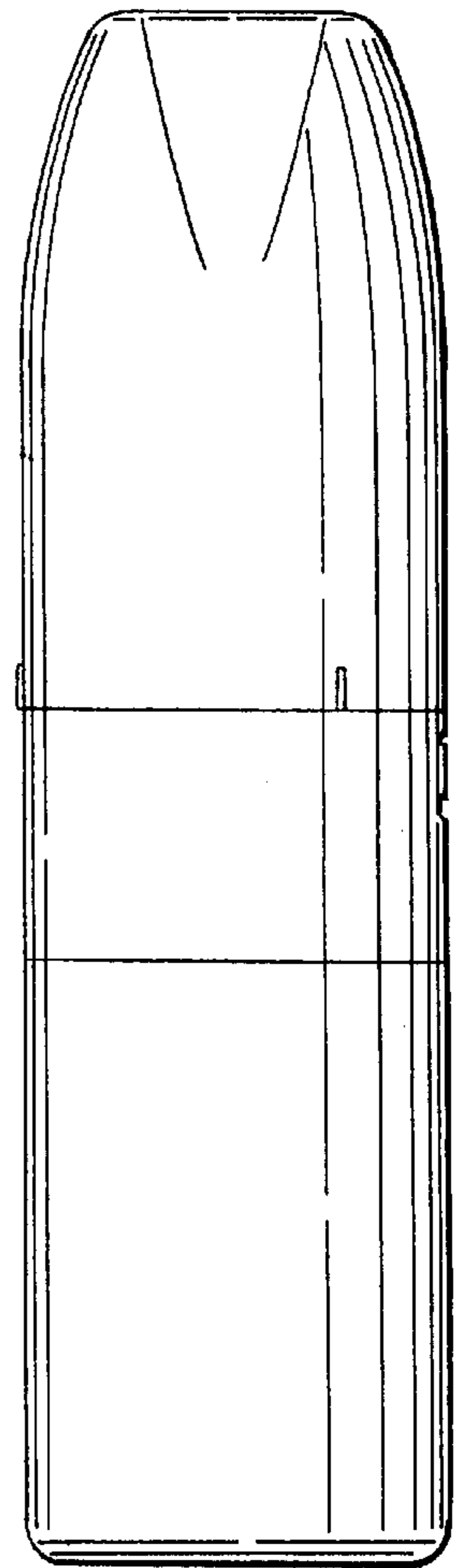

Fig.4

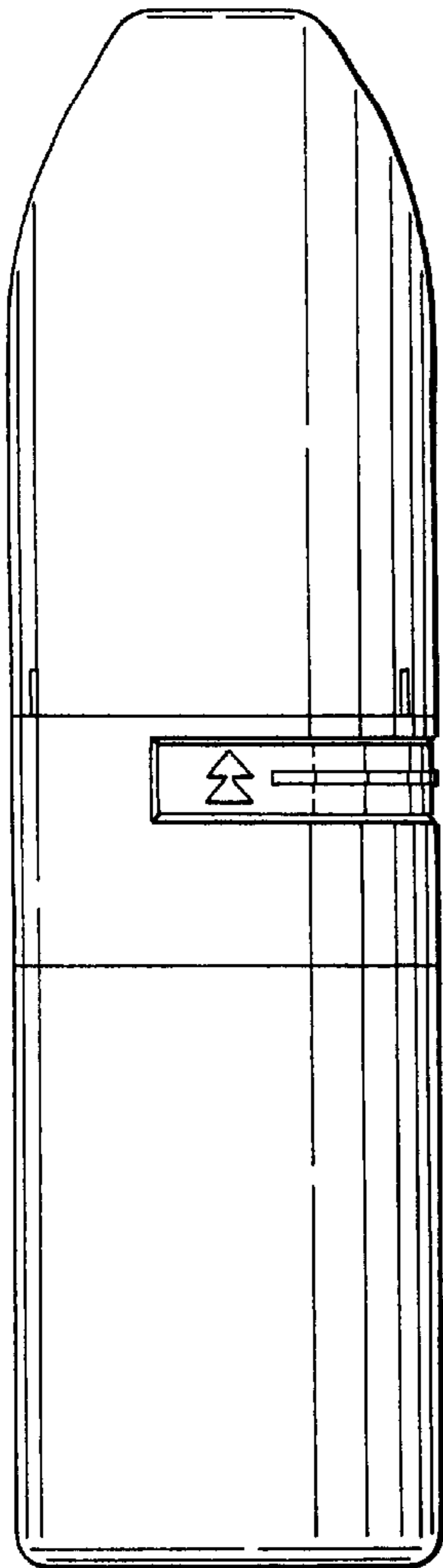

Fig.5

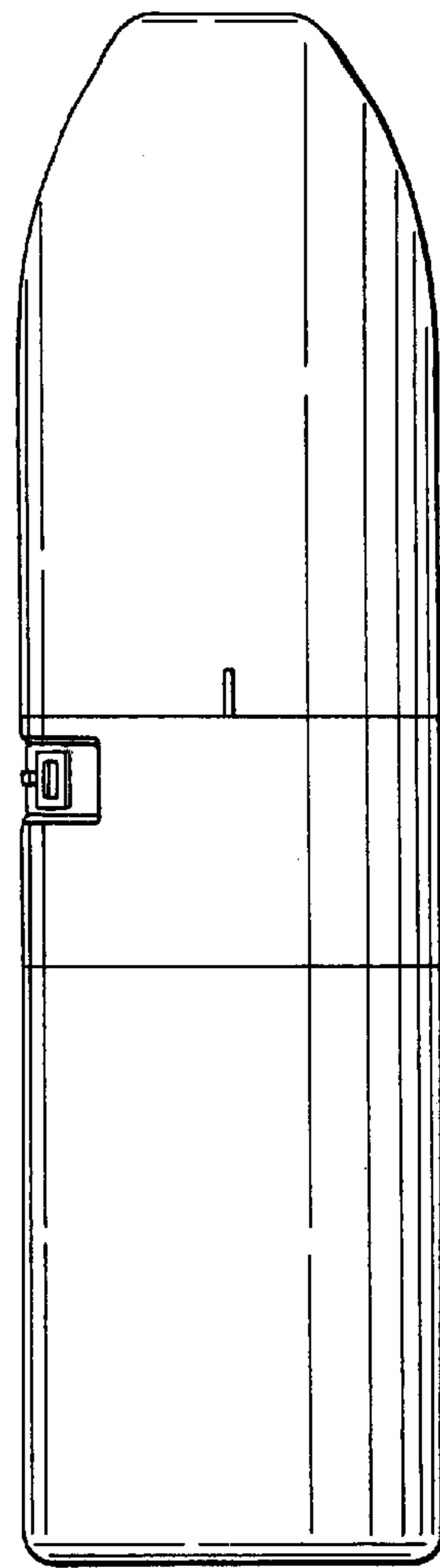

Fig.6

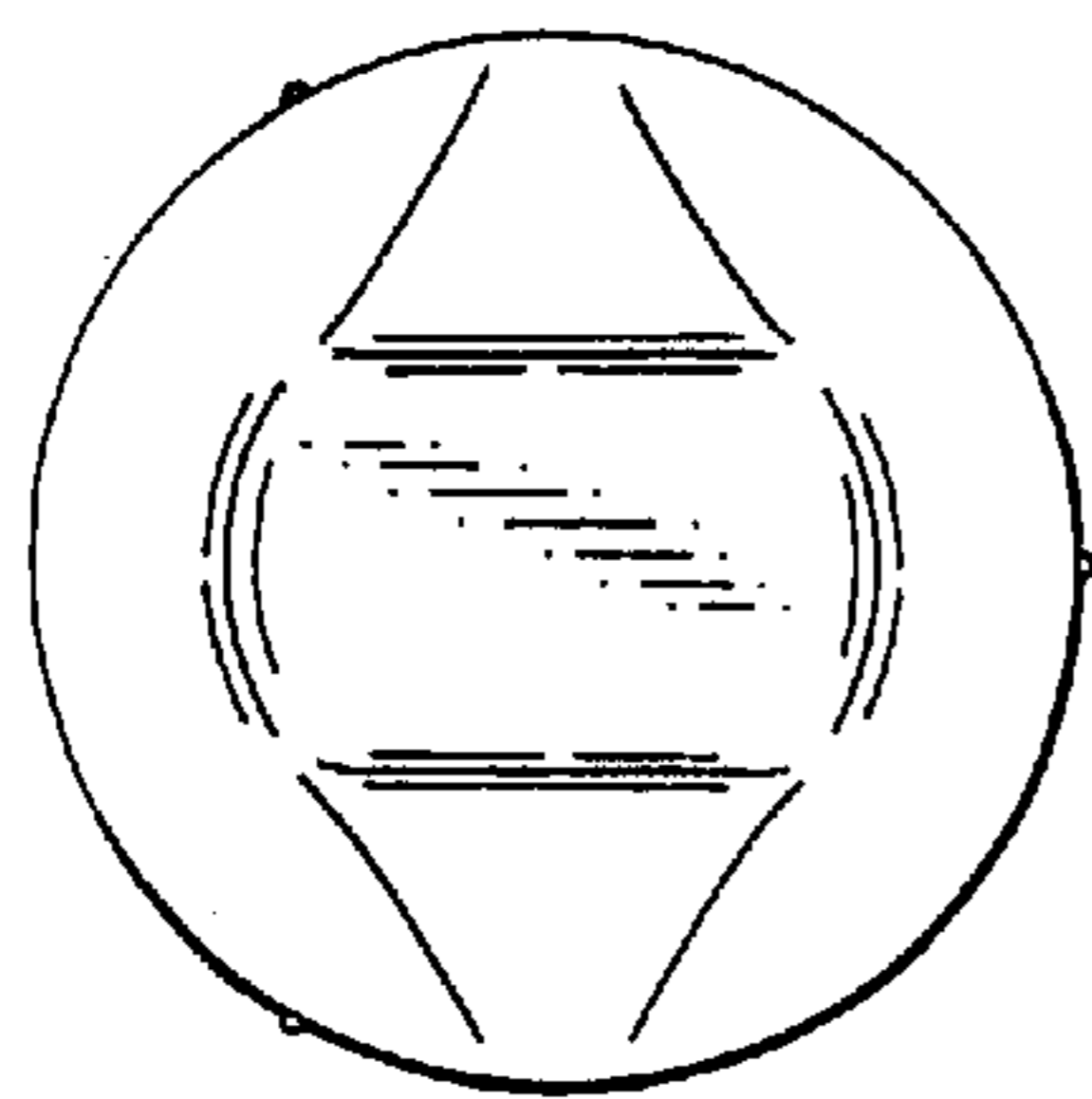

Fig.7

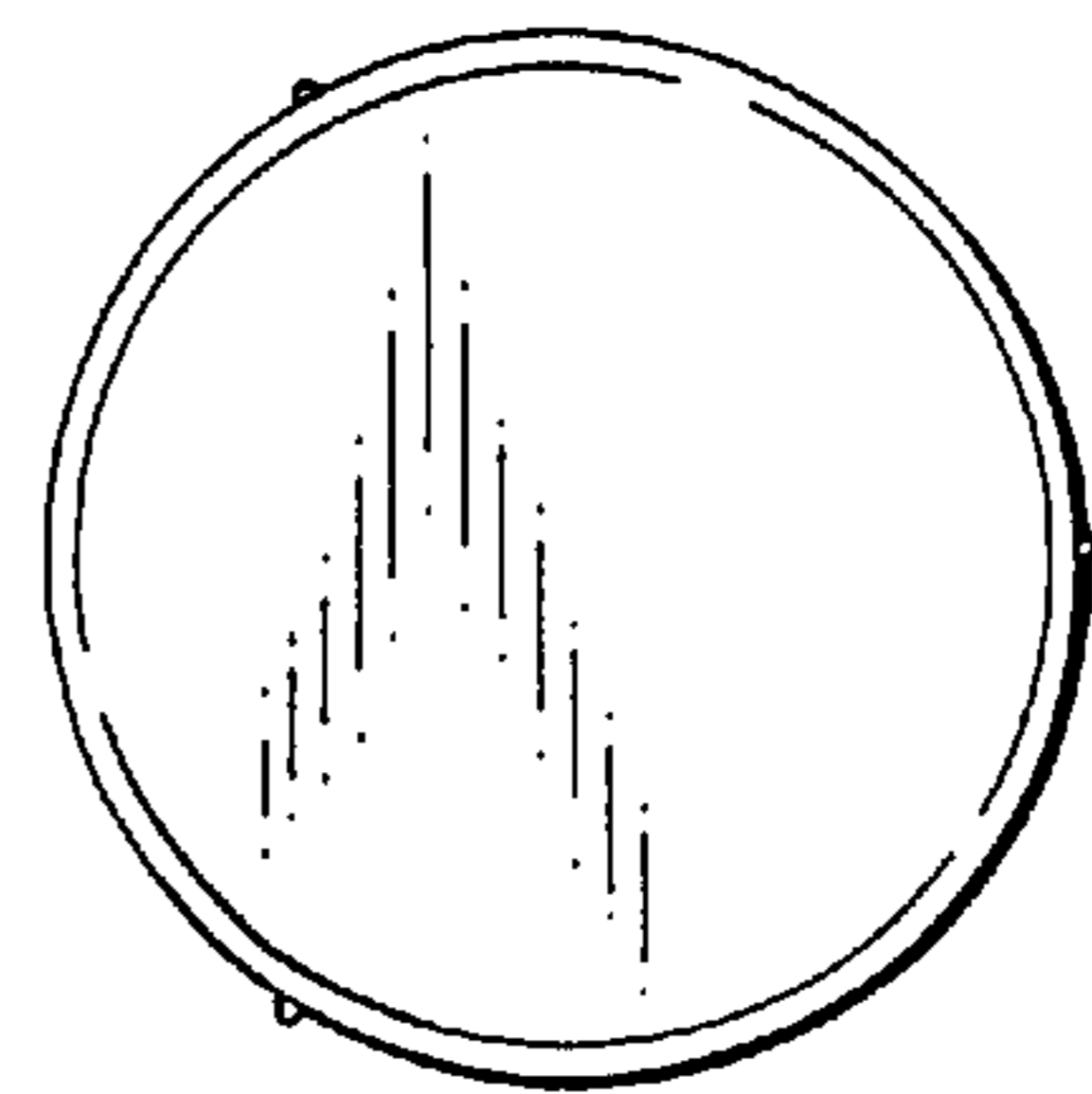

Fig.8

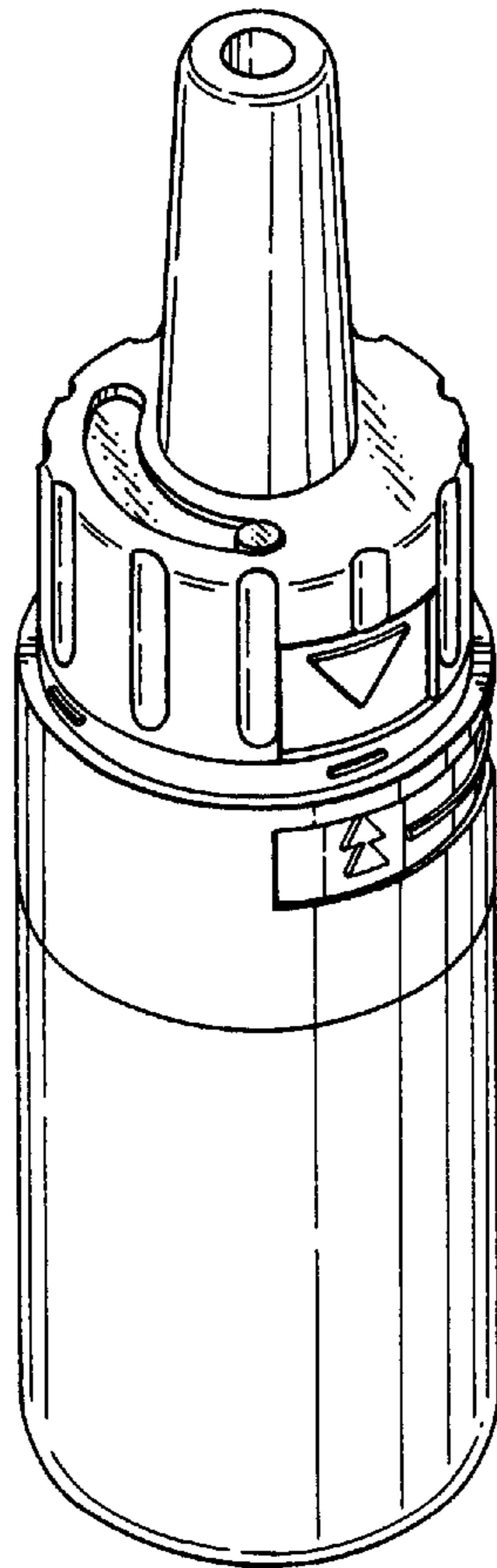
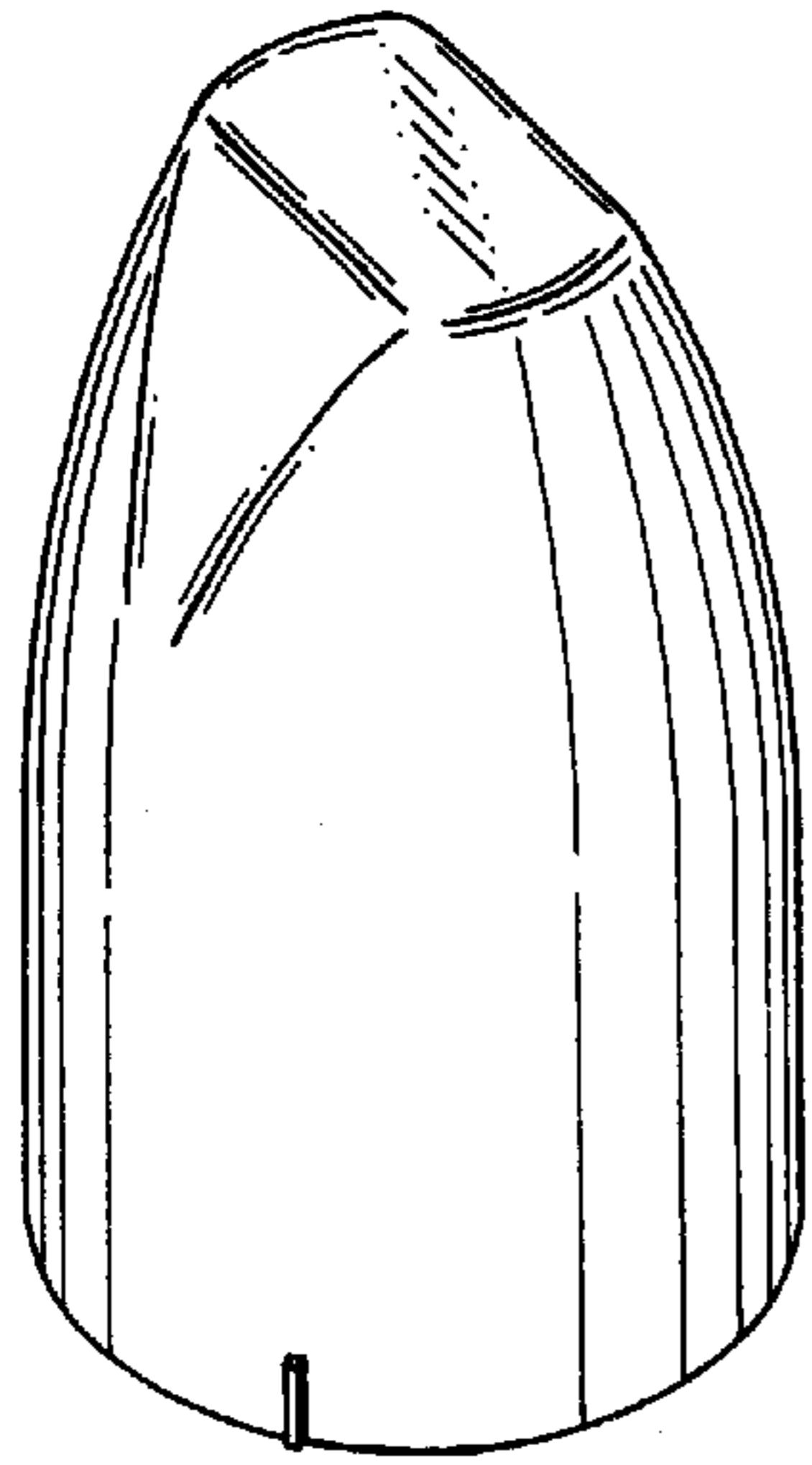

Fig.9

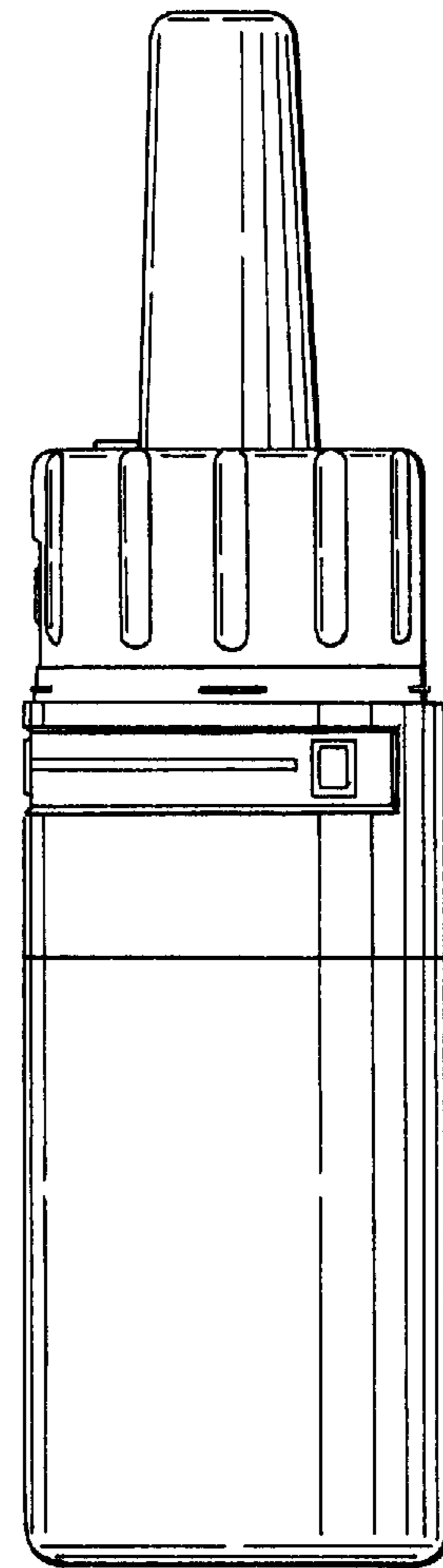
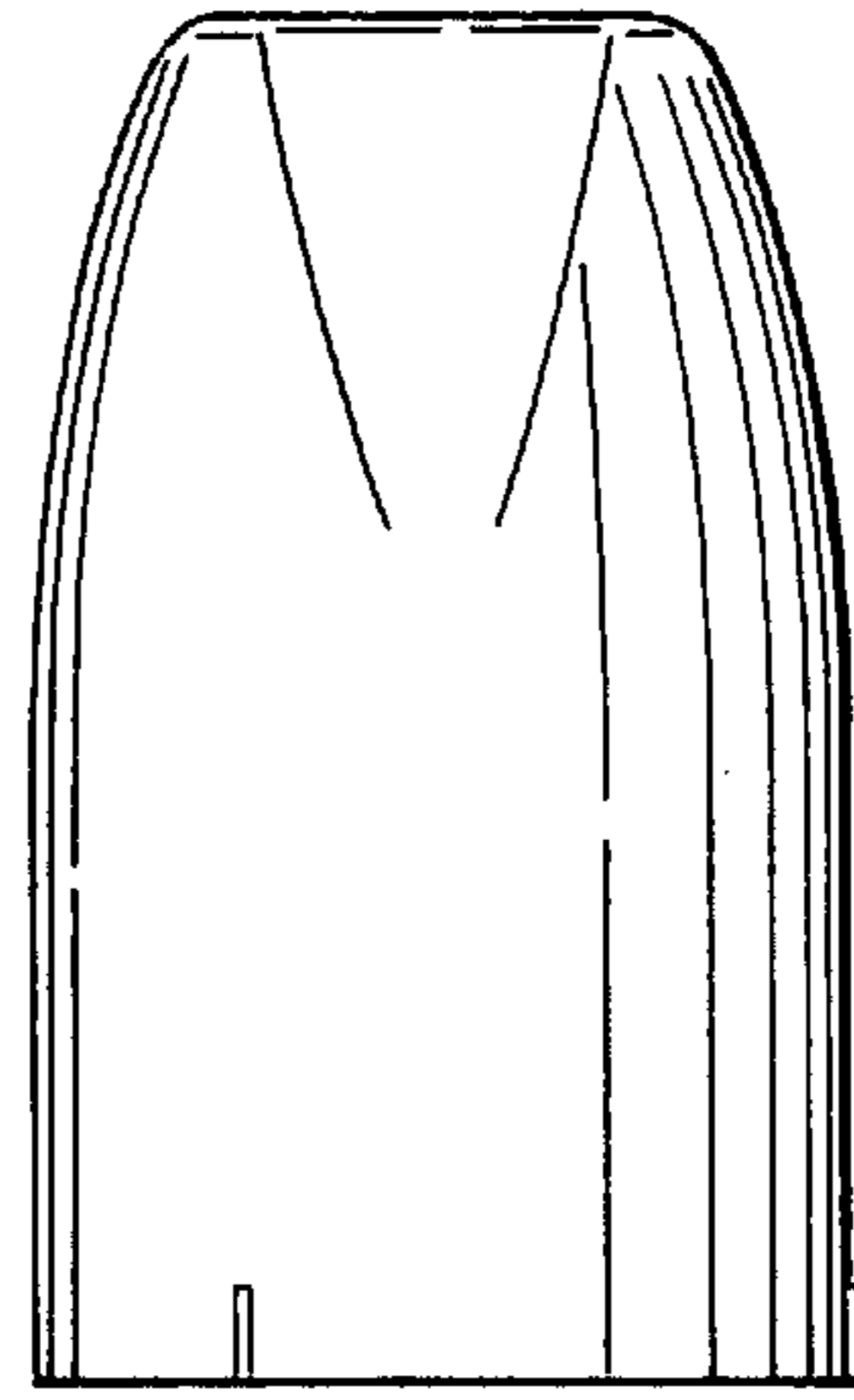

Fig.10

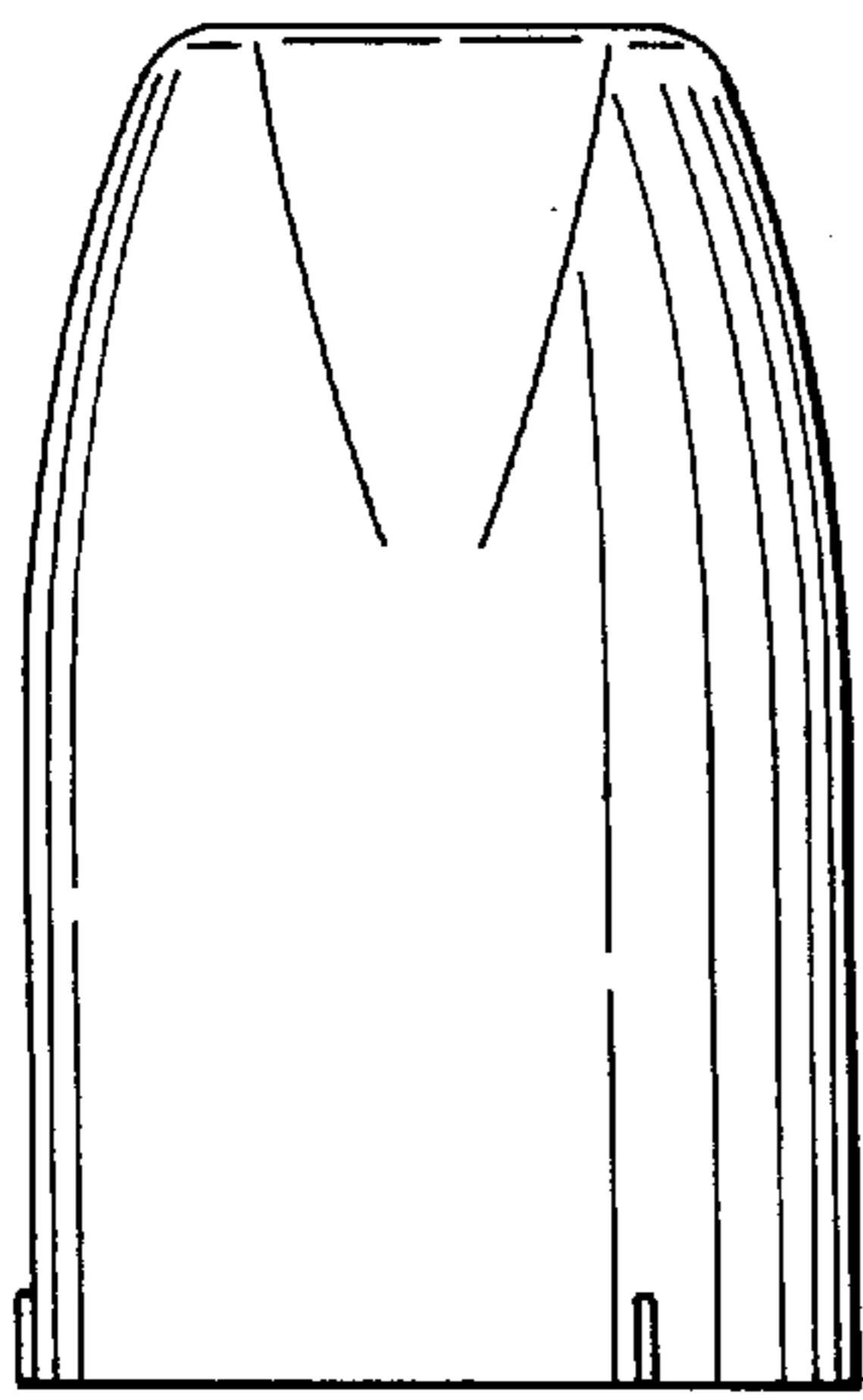

Fig.11

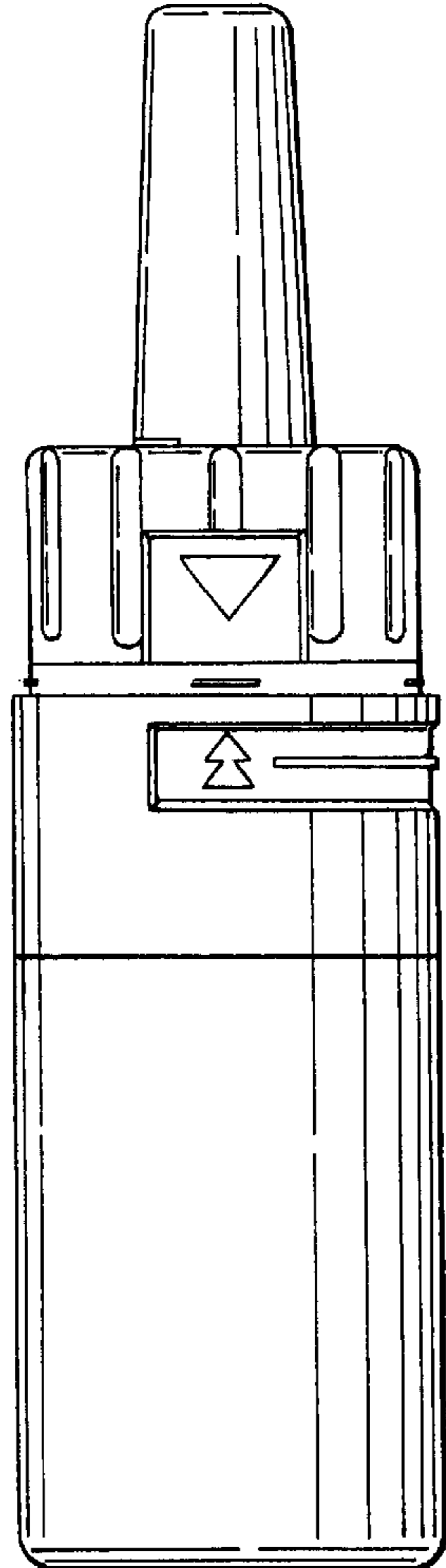
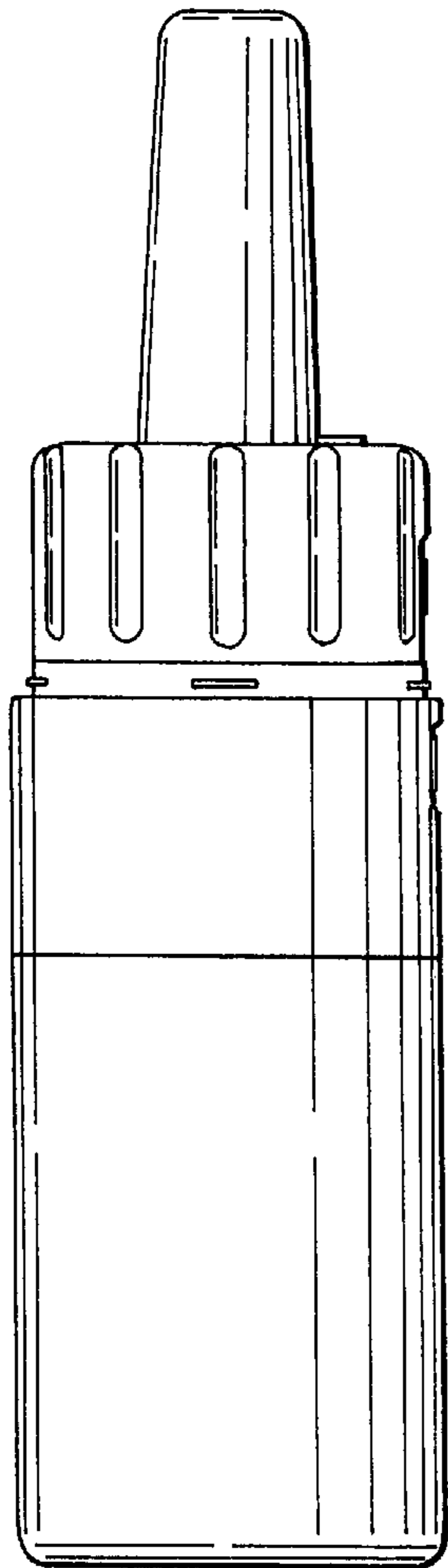
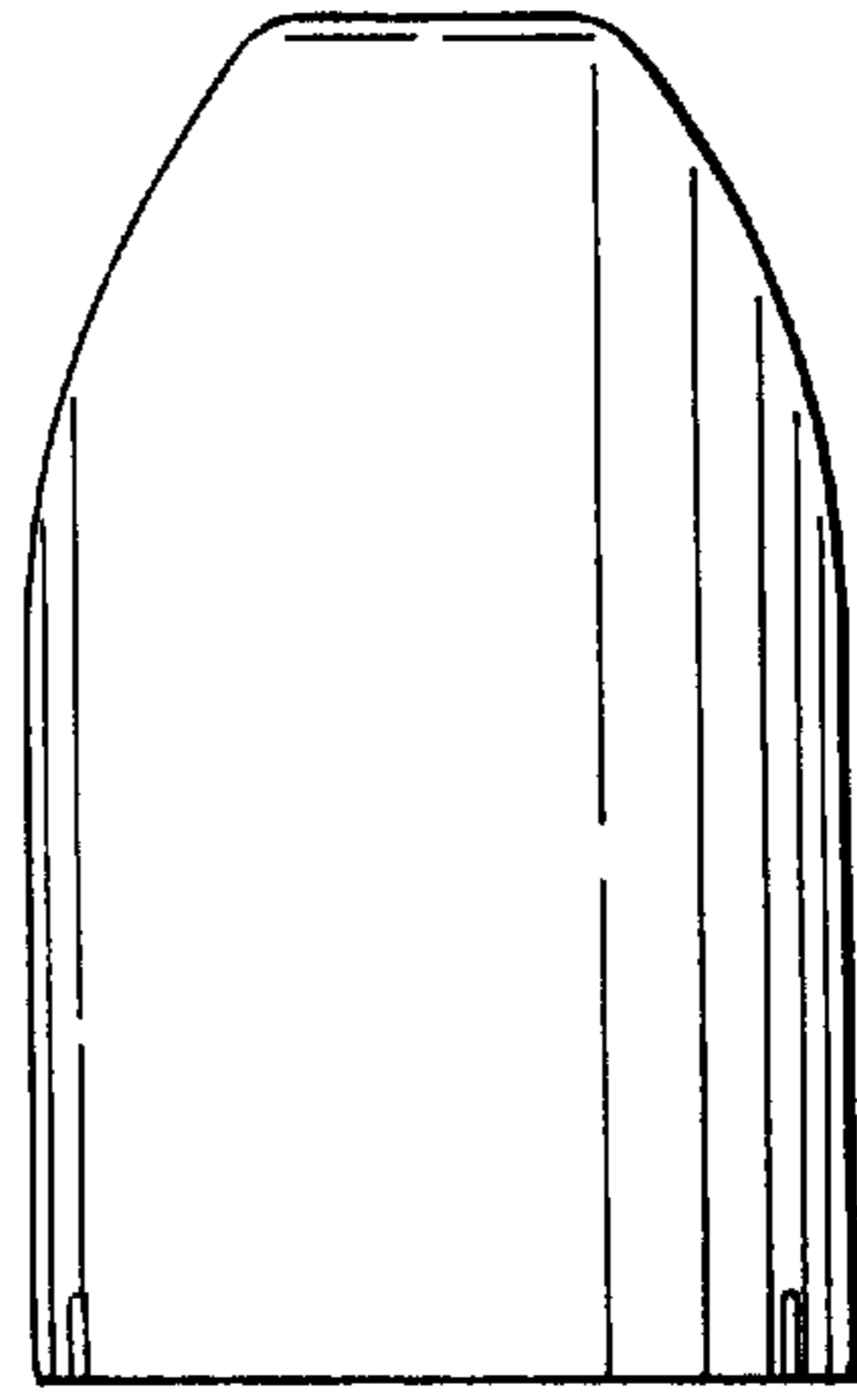

Fig.12

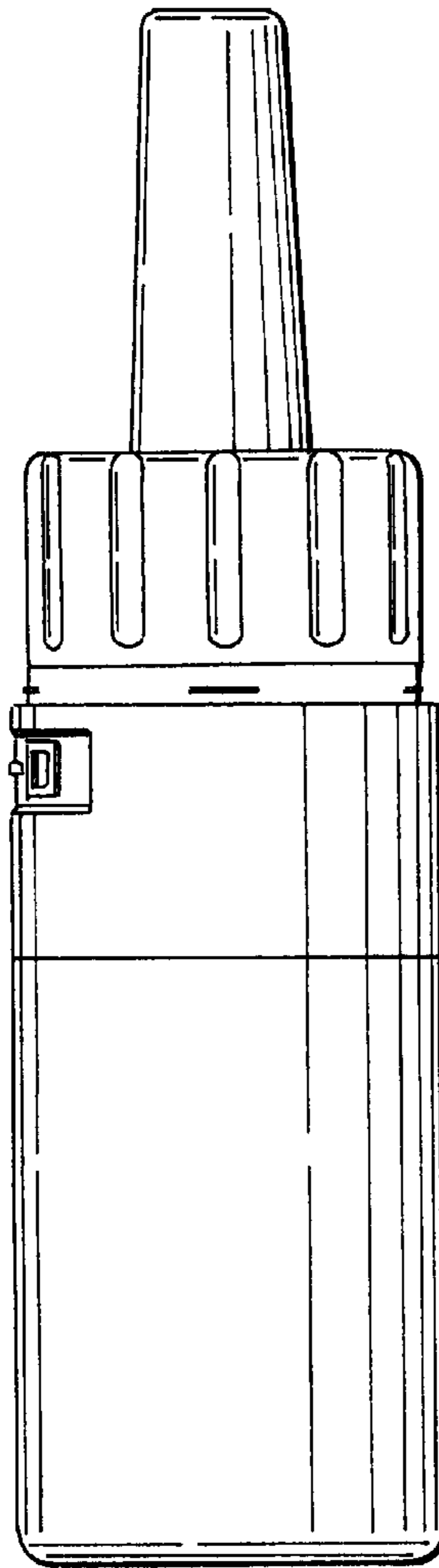
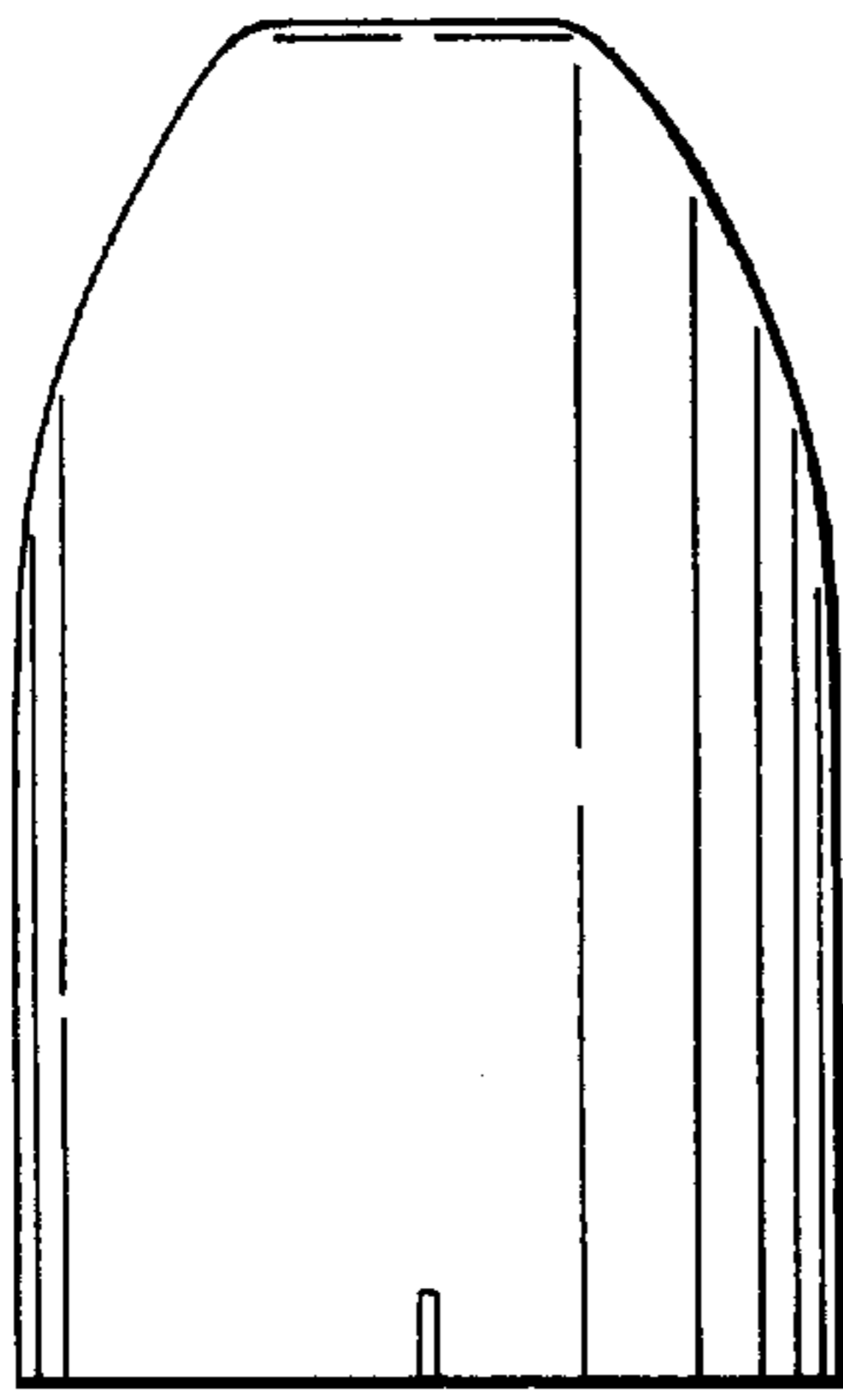

Fig.13

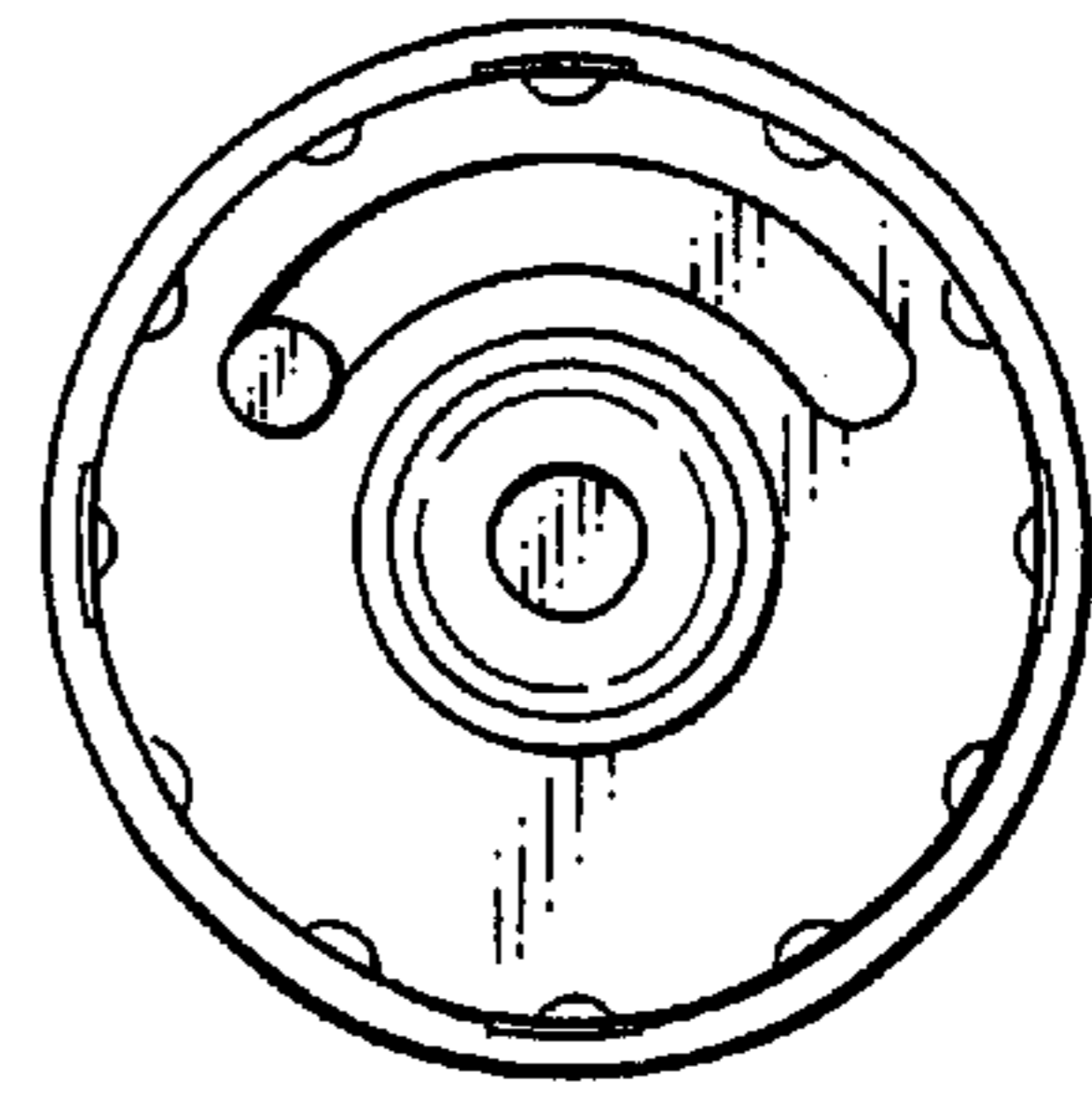

Fig.14

