



US00D447150B1

(12) **United States Design Patent**
Miyazawa et al.

(10) **Patent No.:** **US D447,150 S**

(45) **Date of Patent:** **** Aug. 28, 2001**

(54) **PISTON FOR A REFRIGERANT COMPRESSOR**

Primary Examiner—Ralf Seifert
(74) *Attorney, Agent, or Firm*—Baker Botts L.L.P.

(75) Inventors: **Kiyoshi Miyazawa**, Annaka; **Hiroshi Kanou**, Takasaki; **Mitsuhiro Takashima**, Gunma; **Yuujiro Morita**, Honjou, all of (JP)

(57) **CLAIM**

The ornamental design for a piston for a refrigerant compressor, as shown and described above.

(73) Assignee: **Sanden Corporation**, Gunma (JP)

DESCRIPTION

(**) Term: **14 Years**

FIG. 1 is a left side view of a piston for a refrigerant compressor, according to the design. The right side view is a mirror image of the left side view.

(21) Appl. No.: **29/125,156**

FIG. 2 is a front view of the piston for a refrigerant compressor, as shown in FIG. 1.

(22) Filed: **Jun. 20, 2000**

(30) **Foreign Application Priority Data**

FIG. 3 is a top view of the piston for a refrigerant compressor, as shown in FIG. 1.

Dec. 20, 1999 (JP) 11-35059

FIG. 4 is a bottom view of the piston for a refrigerant compressor, as shown in FIG. 1.

(51) **LOC (7) Cl.** **15-01**

FIG. 5 is a rear view of the piston for a refrigerant compressor, as shown in FIG. 1.

(52) **U.S. Cl.** **D15/9**

FIG. 6 is a cross-sectional view of a refrigerant compressor taken along the line 6—6 of FIG. 1;

(58) **Field of Search** D15/5-9; 417/545, 417/222.1, 266, 269, 273; 91/505; 92/71, 12.2, 165.12; 74/60

FIG. 7 is a cross-sectional view of the refrigerant compressor taken along the line 7—7 of FIG. 1;

(56) **References Cited**

U.S. PATENT DOCUMENTS

- D. 402,295 * 12/1998 Kayukawa et al. D15/9
- D. 417,225 * 11/1999 Kimura et al. D15/5
- D. 417,876 * 12/1999 Kayukawa et al. D15/9
- D. 427,611 * 7/2000 Yokota et al. D15/9
- D. 428,423 * 7/2000 Takamatsu et al. D15/9
- D. 435,563 * 12/2000 Muraro et al. D15/9

FIG. 8 is a cross-sectional view of the refrigerant compressor taken along the line 8—8 of FIG. 1; and,

FIG. 9 is a rear perspective view of the piston for a refrigerant compressor of FIG. 1.

* cited by examiner

1 Claim, 3 Drawing Sheets

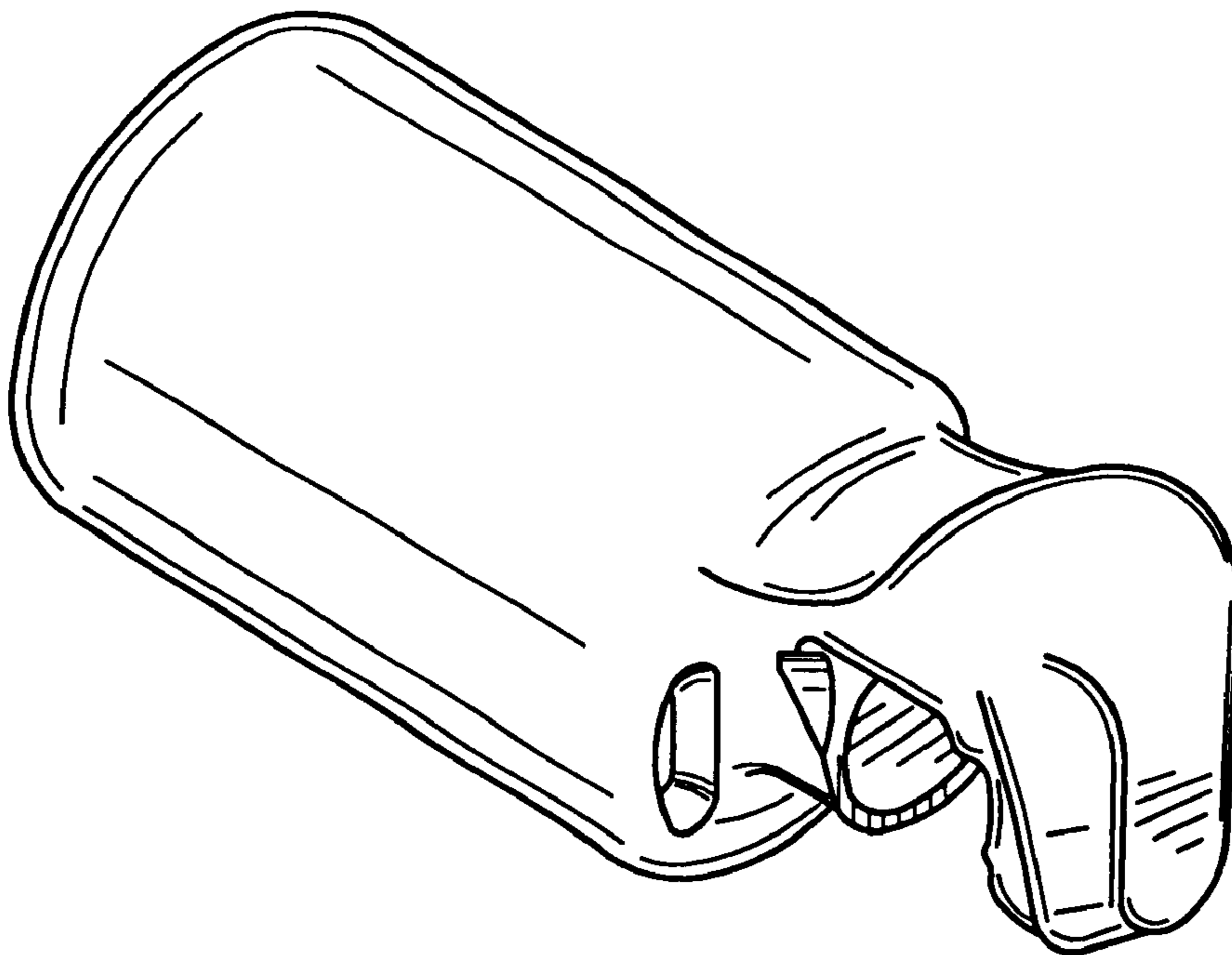

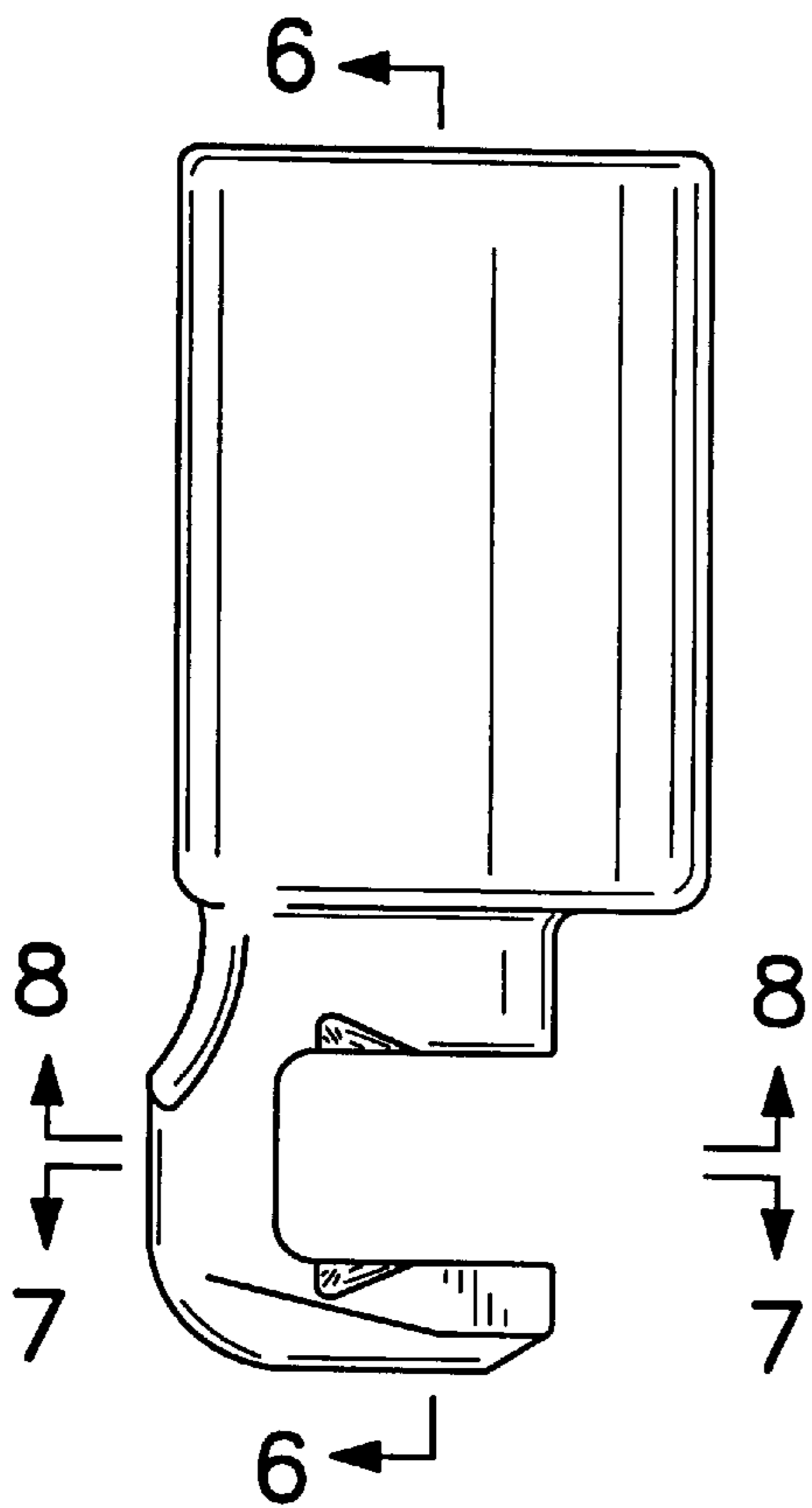

FIG. 1

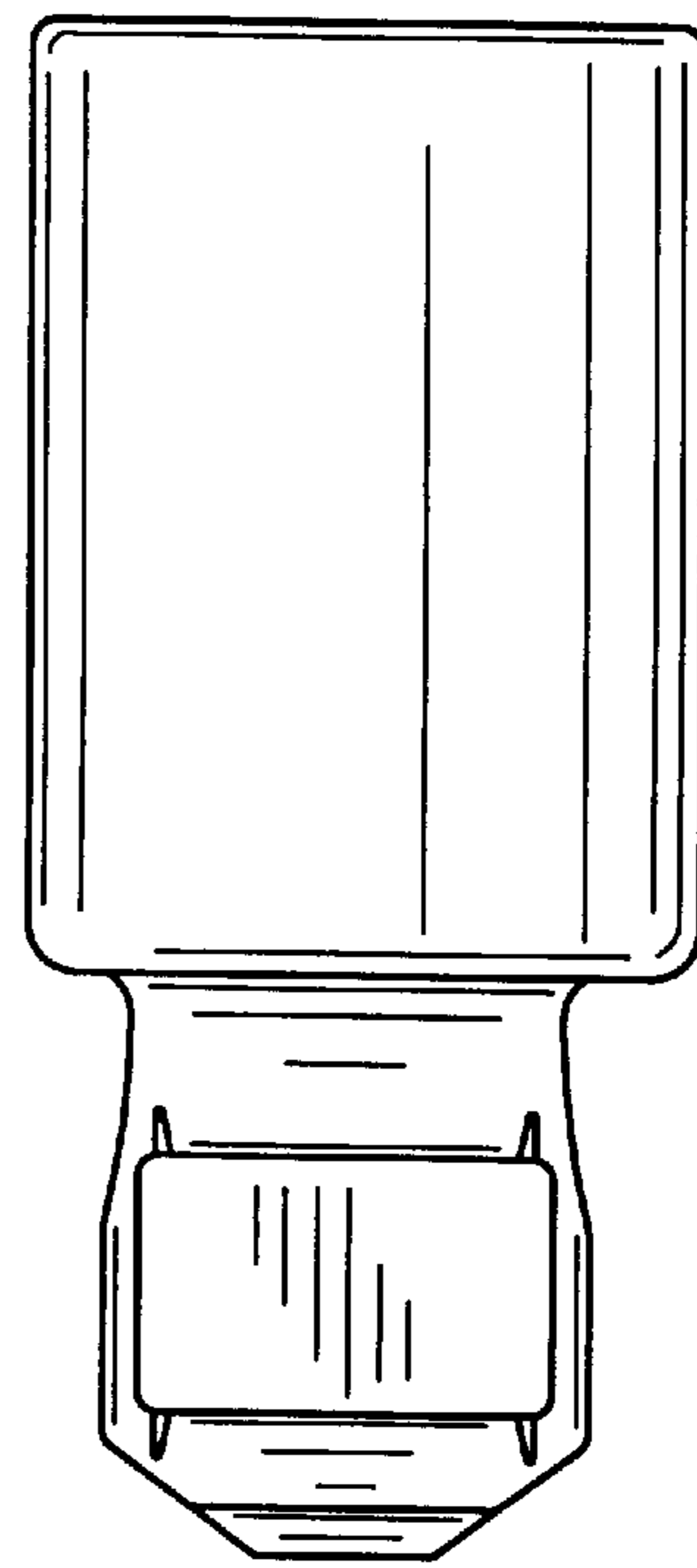

FIG. 2

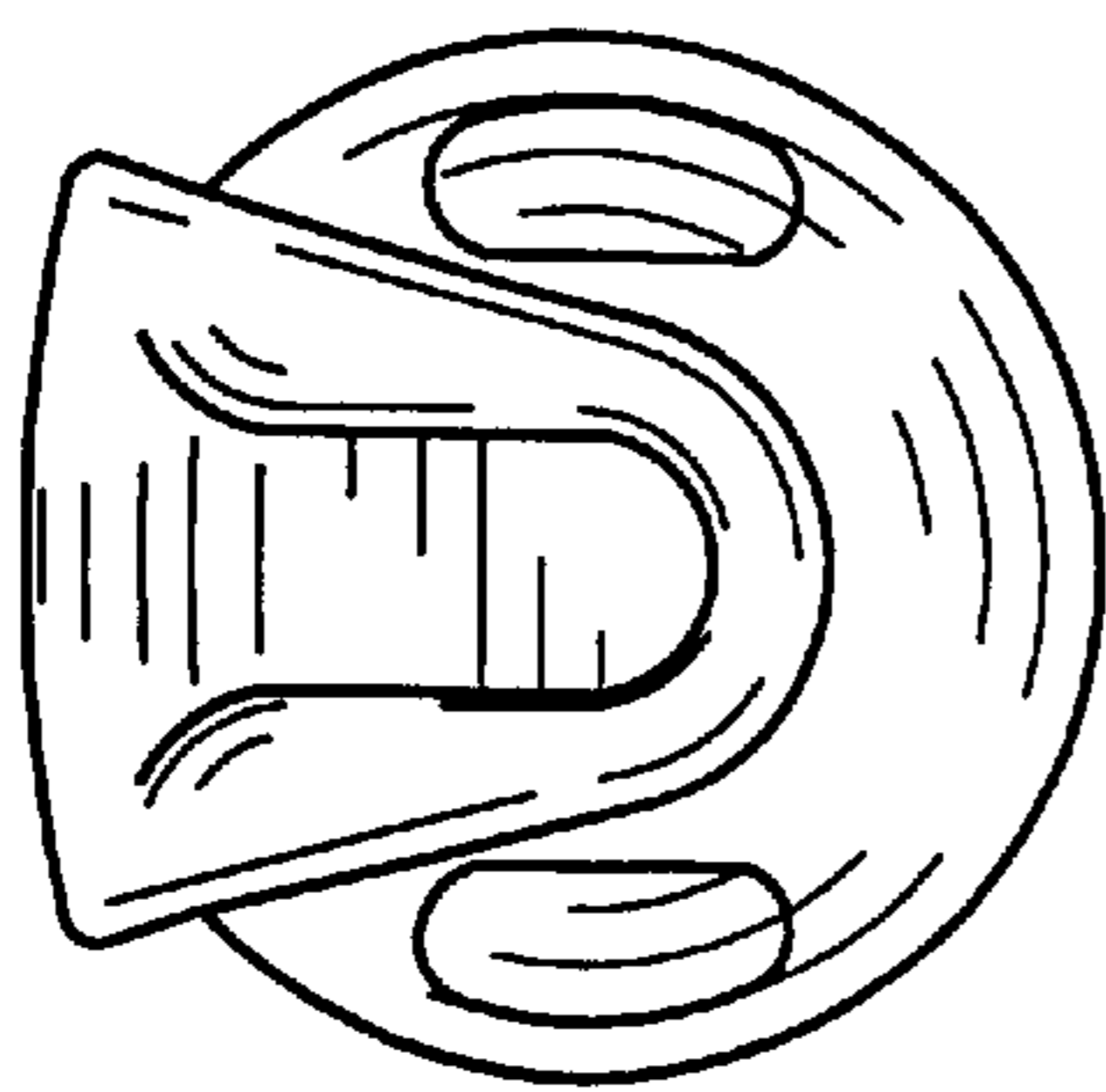

FIG. 3

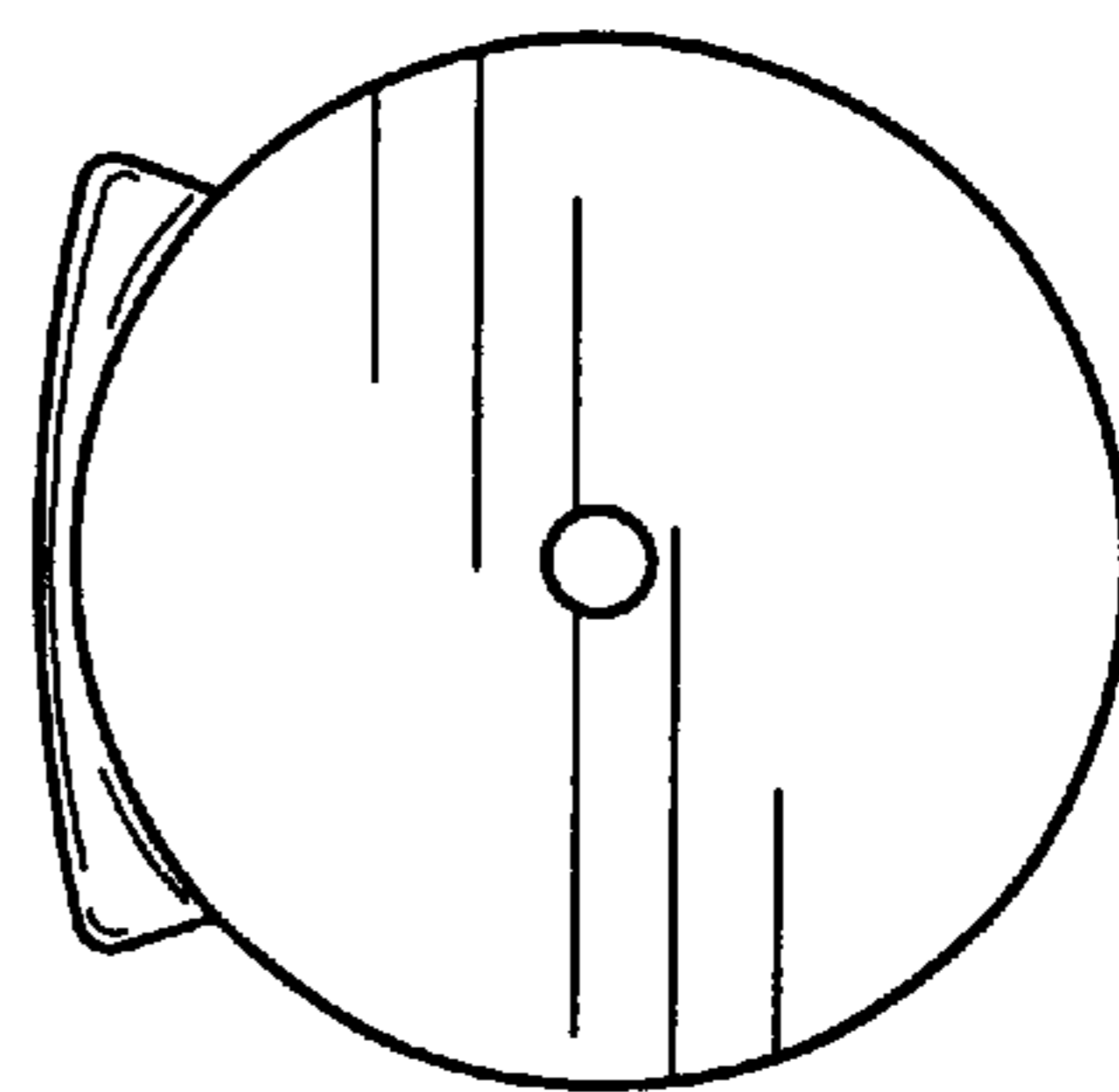

FIG. 4

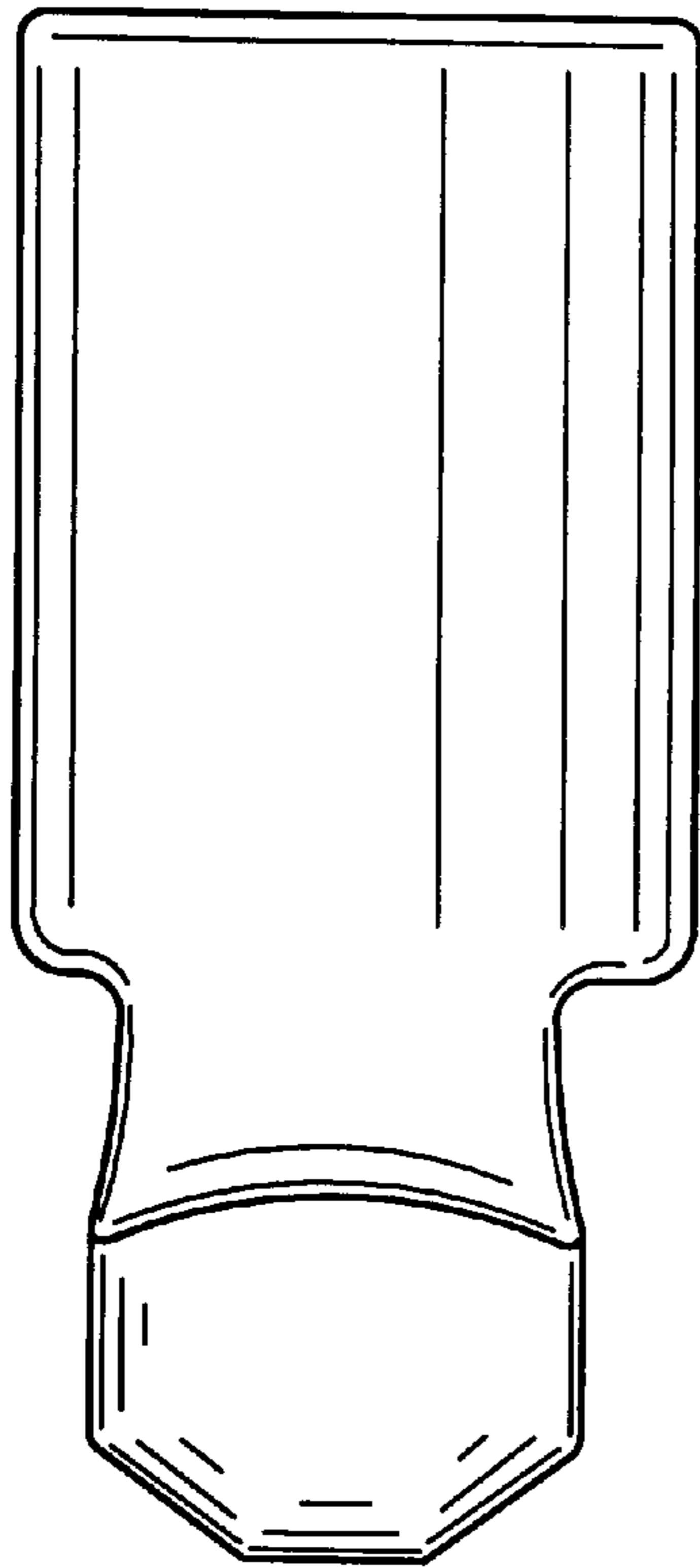

FIG. 5

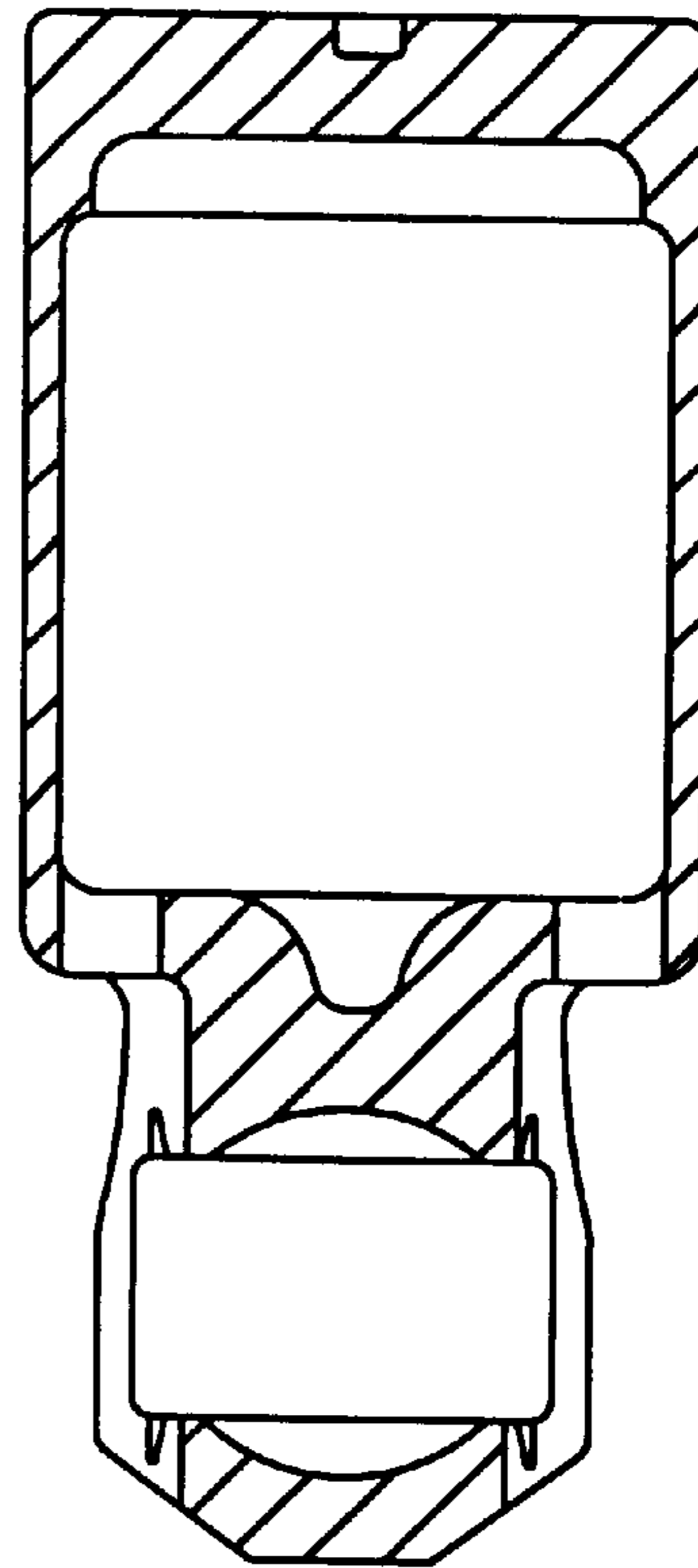

FIG. 6

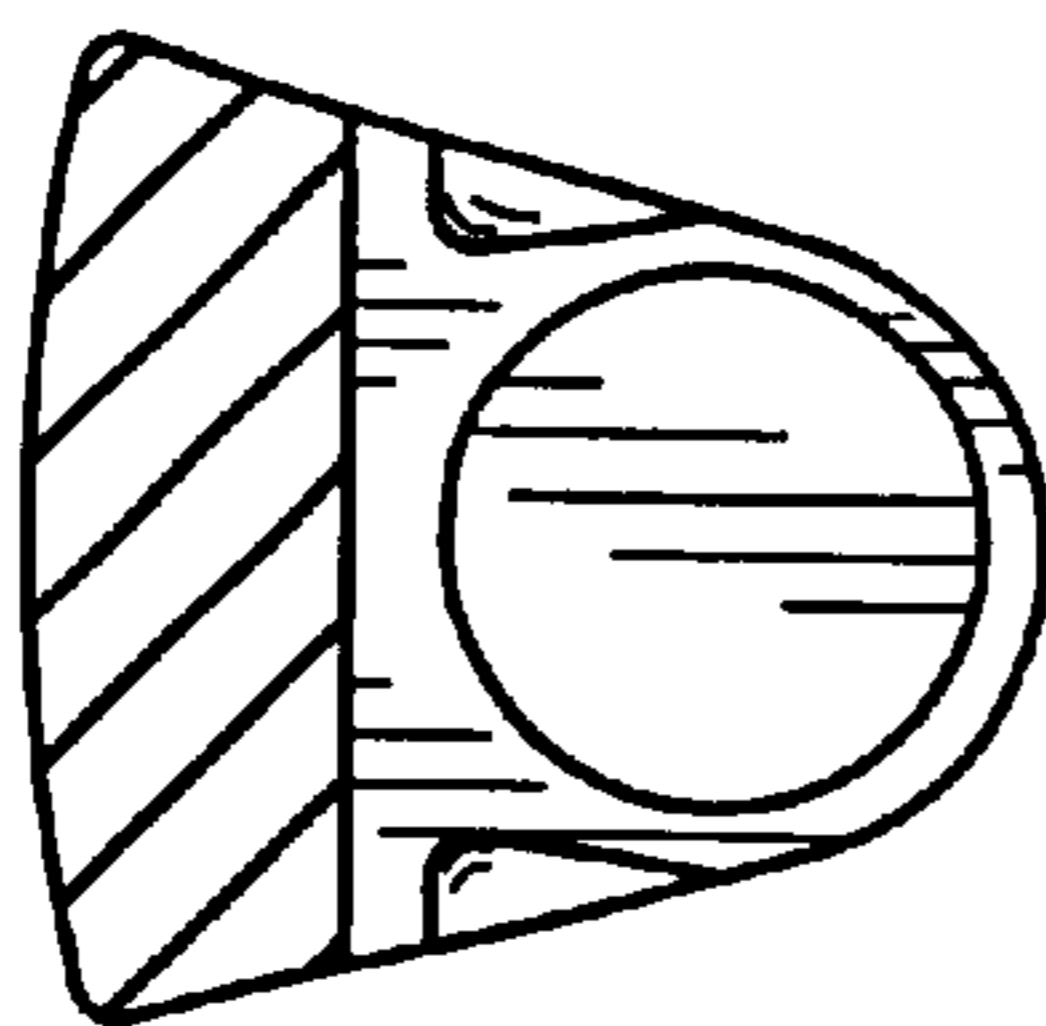

FIG. 7

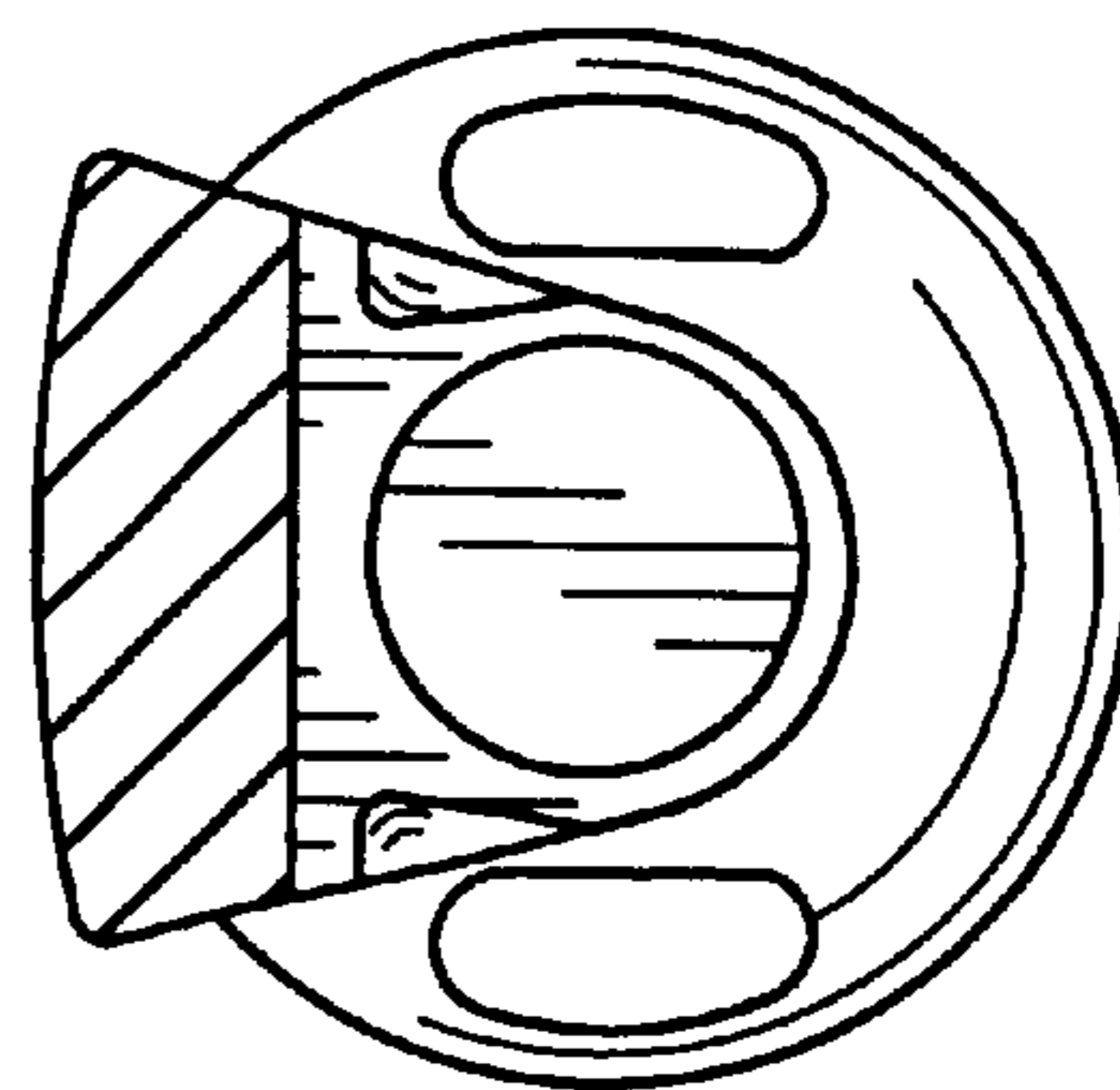

FIG. 8

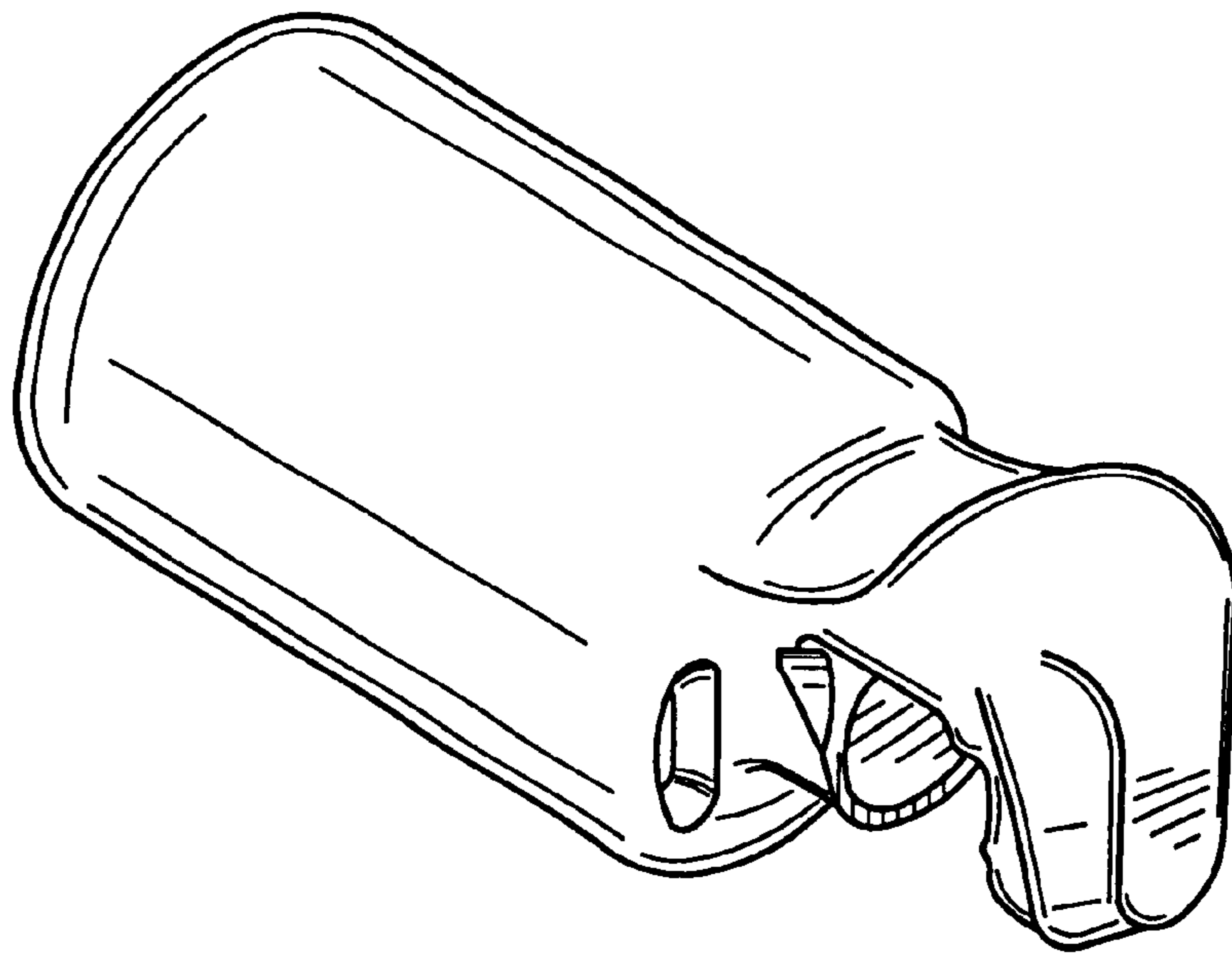

FIG. 9