



US00D447139B1

(12) **United States Design Patent**  
**Mache et al.**

(10) **Patent No.:** **US D447,139 S**

(45) **Date of Patent:** **\*\* Aug. 28, 2001**

(54) **PERSONAL COMPUTER**

(75) Inventors: **Olivier Mache**, Grenoble (FR); **Nicolai Furhmann**, Milan (IT); **Daniele Testa**, Porto Recanati (IT); **Luigi Rovere**, Milan (IT)

(73) Assignee: **Hewlett-Packard Company**, Palo Alto, CA (US)

(\*\*) Term: **14 Years**

(21) Appl. No.: **29/127,950**

(22) Filed: **Aug. 14, 2000**

(30) **Foreign Application Priority Data**

Feb. 14, 2000 (FR) ..... 00 0875

(51) **LOC (7) Cl.** ..... **14-02**

(52) **U.S. Cl.** ..... **D14/351**

(58) **Field of Search** ..... D14/349, 351,  
D14/352, 353, 356; D13/162, 184, 199;  
312/223.1, 223.2, 223.3; 360/99.12; 361/694,  
696; 369/34, 36

(56) **References Cited**

**U.S. PATENT DOCUMENTS**

- D. 370,211 \* 5/1996 Lee ..... D14/349
- D. 406,116 \* 2/1999 Huber et al. .... D14/351
- D. 408,020 \* 4/1999 Han ..... D14/349
- D. 418,490 \* 1/2000 Jobs et al. .... D14/351

\* cited by examiner

*Primary Examiner*—Freda Nunn

(57) **CLAIM**

The ornamental design for a personal computer, as shown and described.

**DESCRIPTION**

FIG. 1 is a perspective side view showing the first embodiment of our design;  
 FIG. 2 is another perspective side view showing the first embodiment;  
 FIG. 3 is a right-side view thereof;  
 FIG. 4 is a left-side view thereof;  
 FIG. 5 is a rear view thereof;  
 FIG. 6 is a front view thereof;  
 FIG. 7 is a top plan view thereof;  
 FIG. 8 is a perspective side view showing the second embodiment of our design;  
 FIG. 9 is another perspective side view showing the second embodiment;  
 FIG. 10 is a right-side view thereof;  
 FIG. 11 is a left-side view thereof;  
 FIG. 12 is a rear view thereof;  
 FIG. 13 is a front view thereof; and,  
 FIG. 14 is a top plan view thereof.

The bottom view of both embodiments of the design is plan and conventional.

The broken lines are shown in the views for illustrative purposes only and form no part of the claimed design.

**1 Claim, 10 Drawing Sheets**

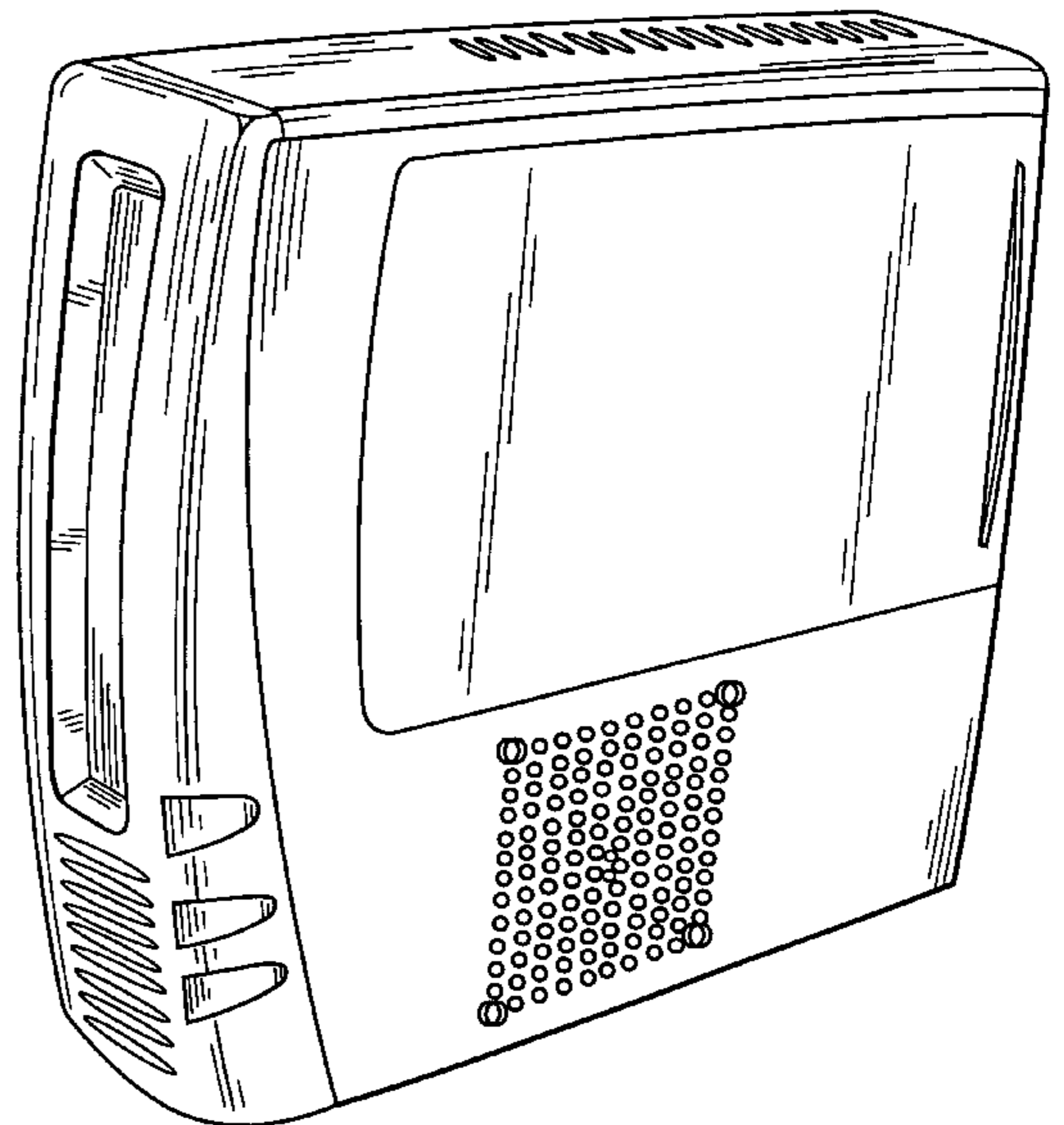
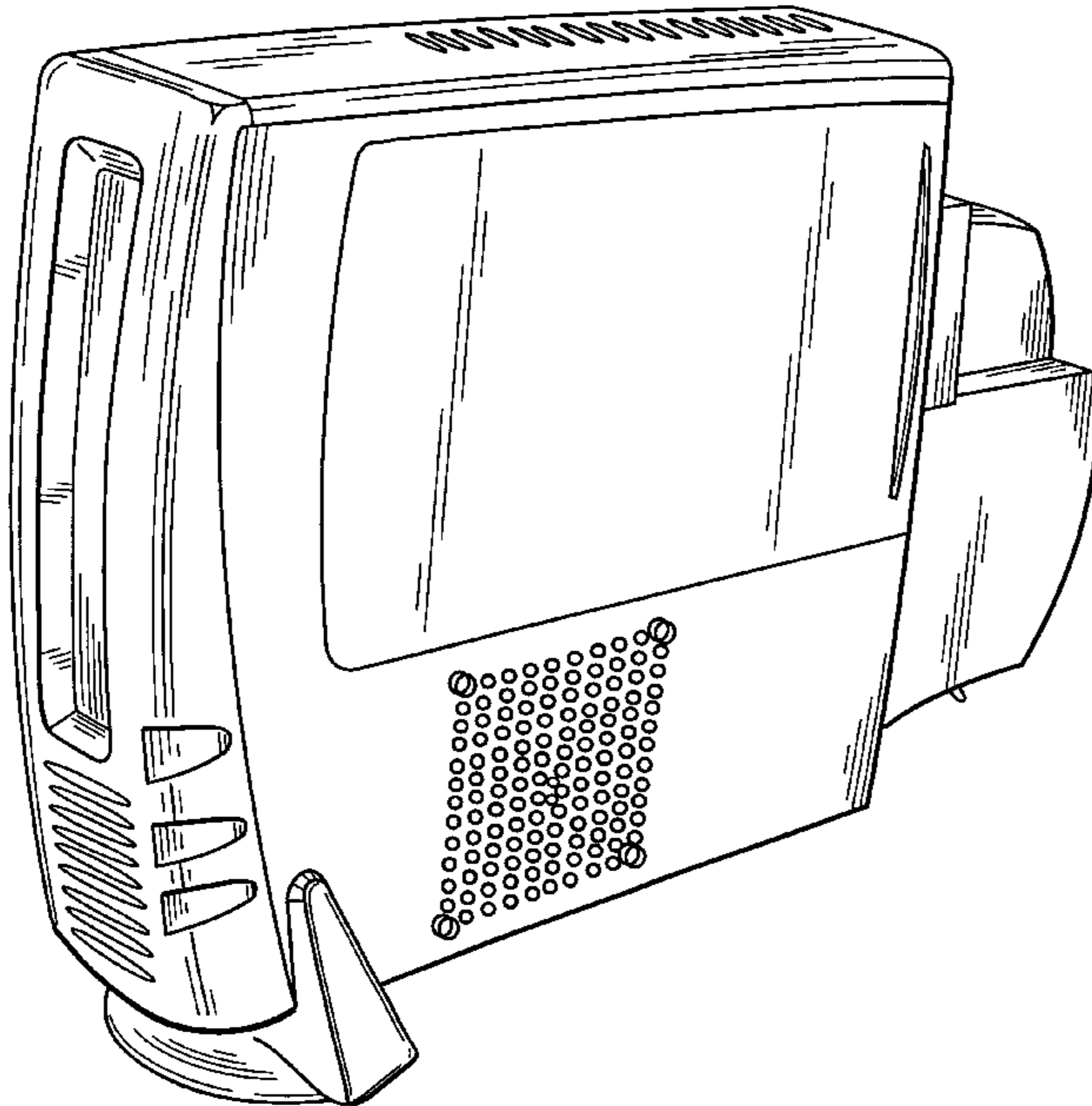

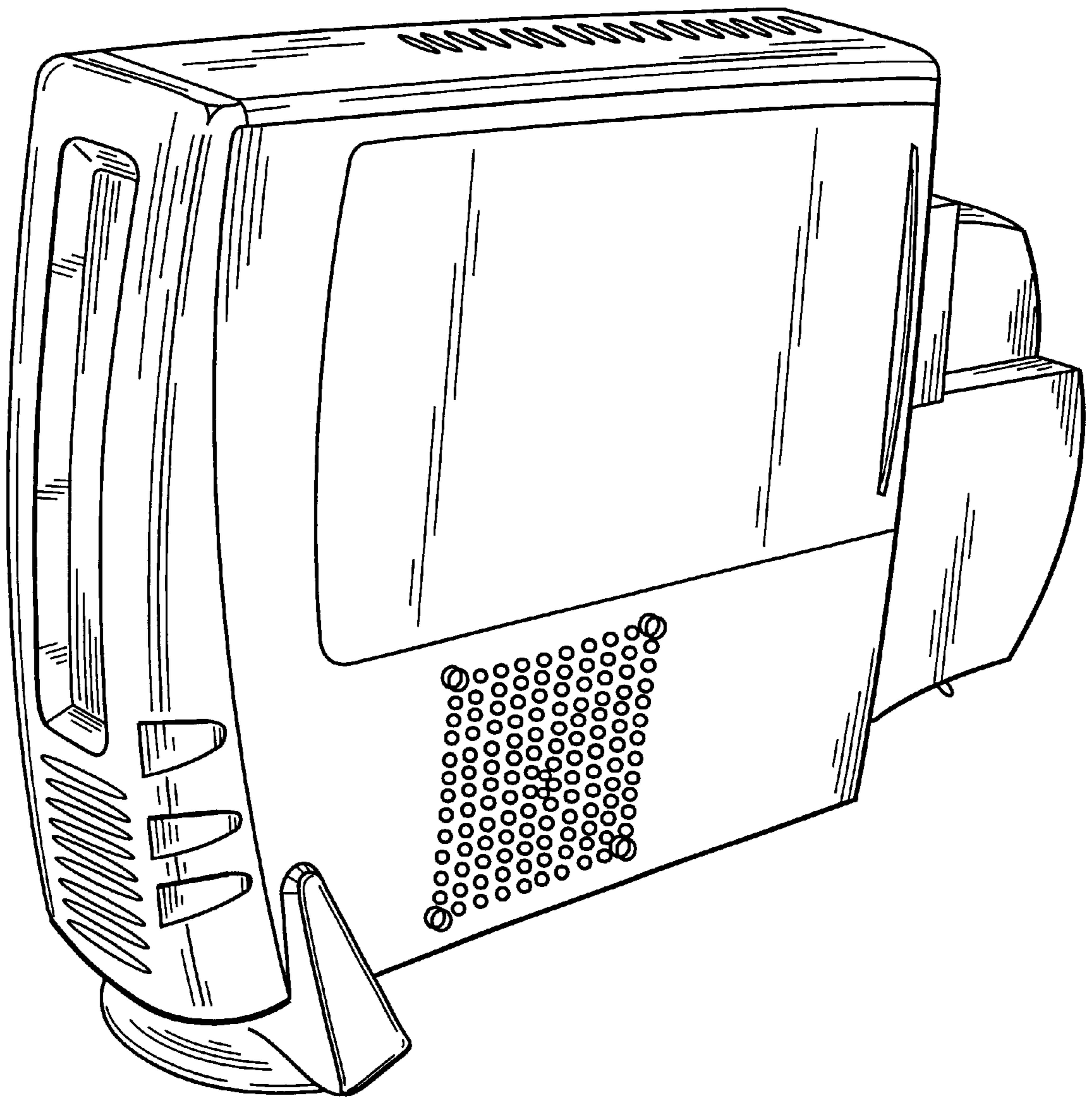

FIG. 1

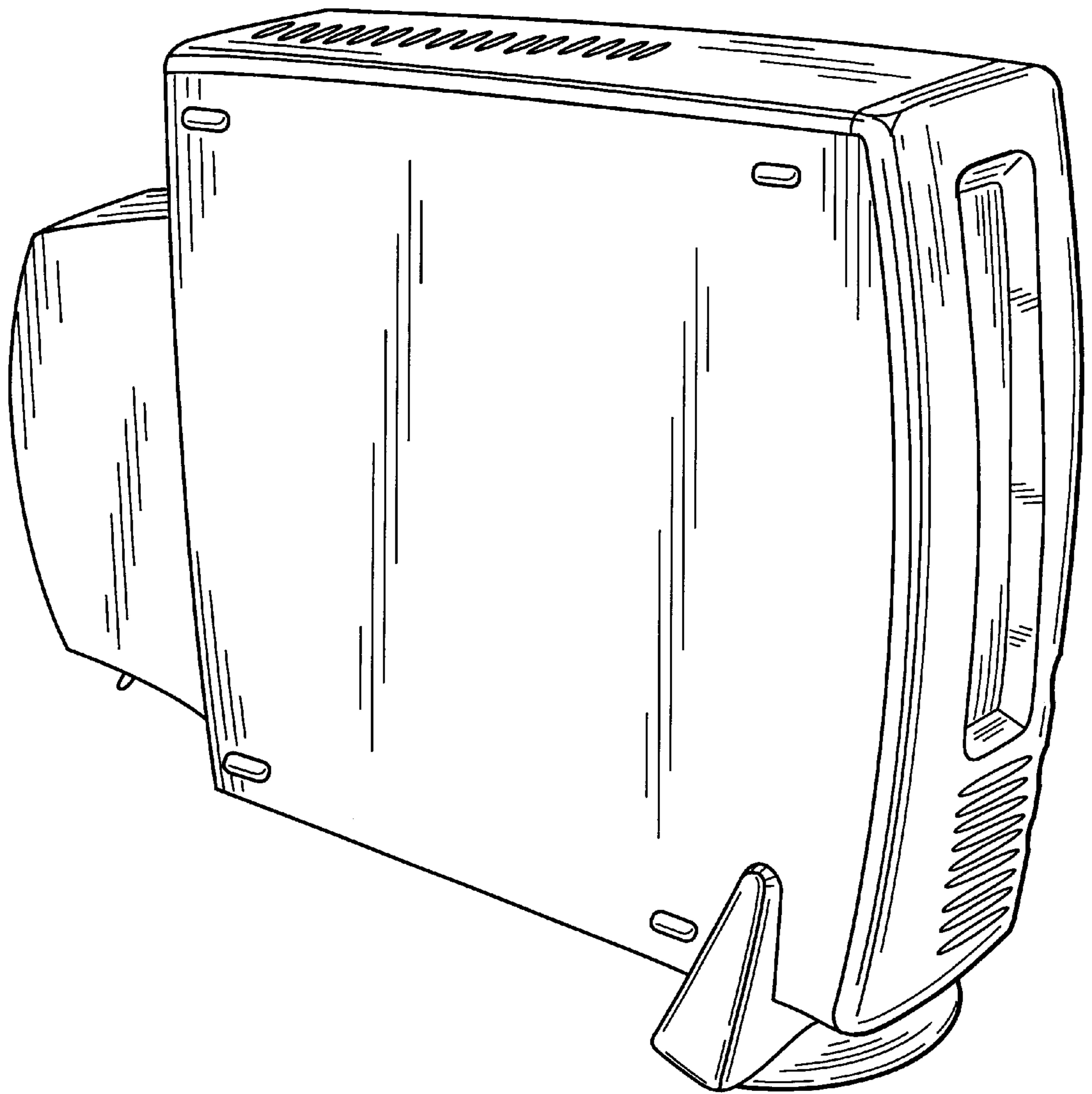

FIG. 2

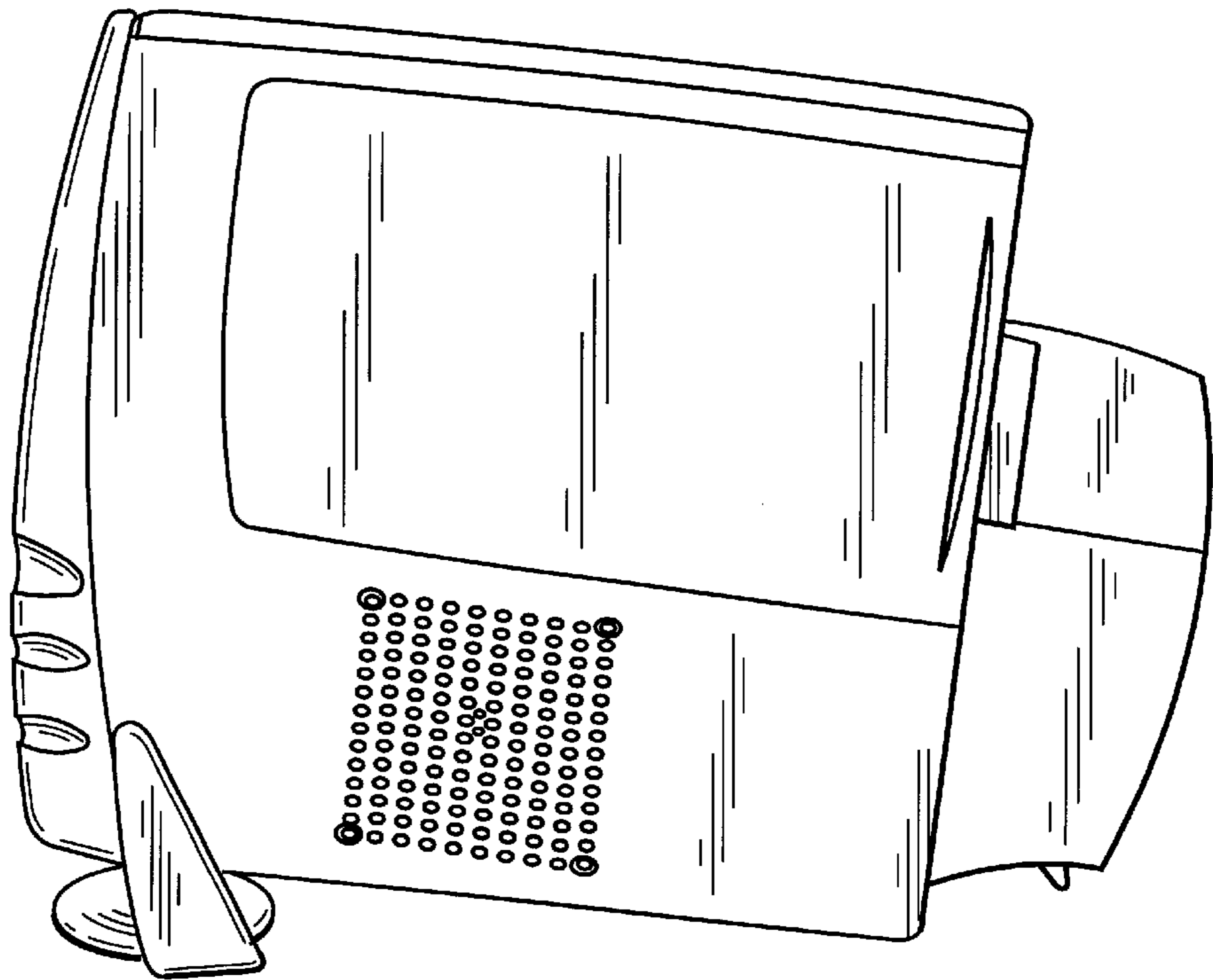

FIG. 3

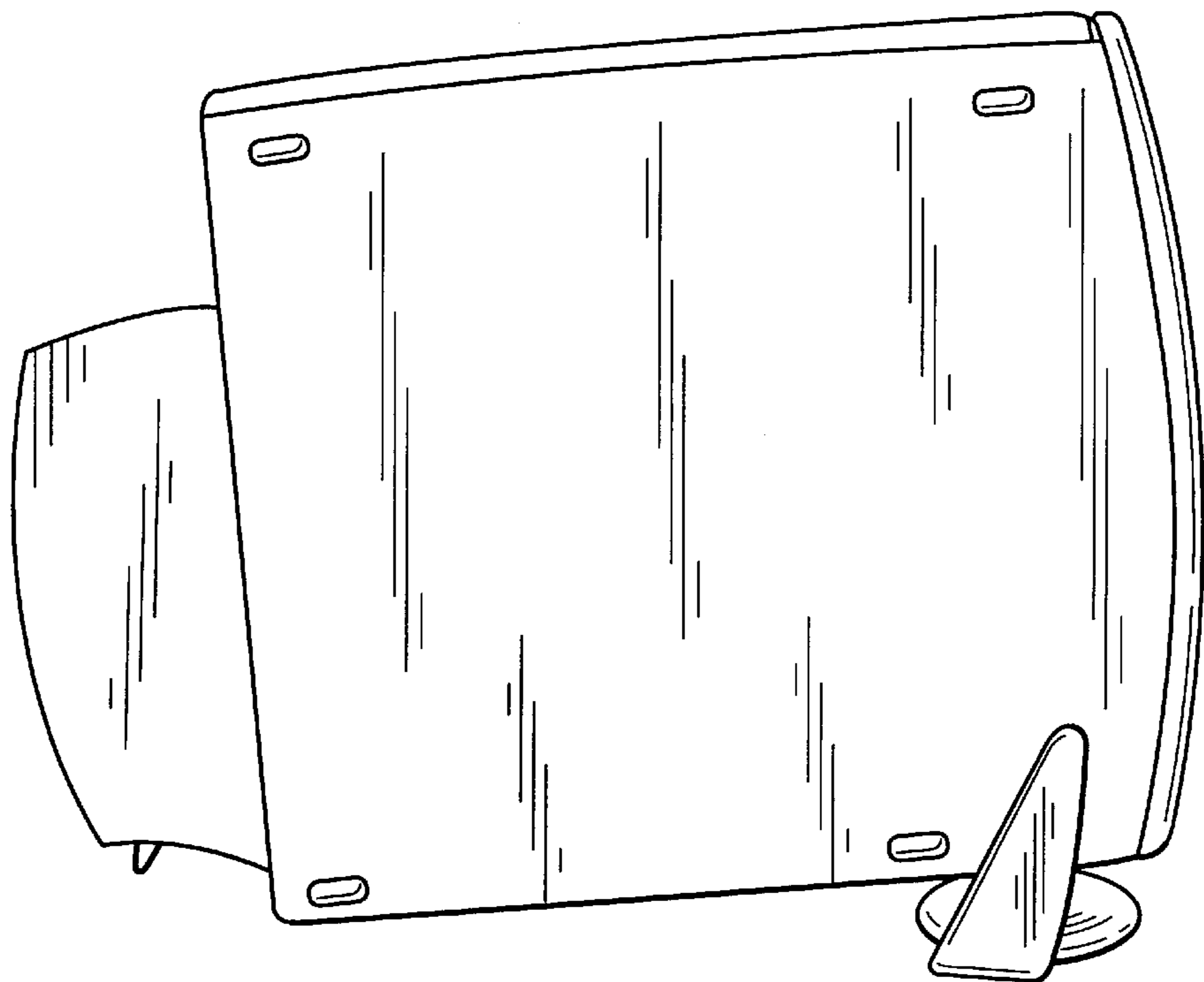

FIG. 4

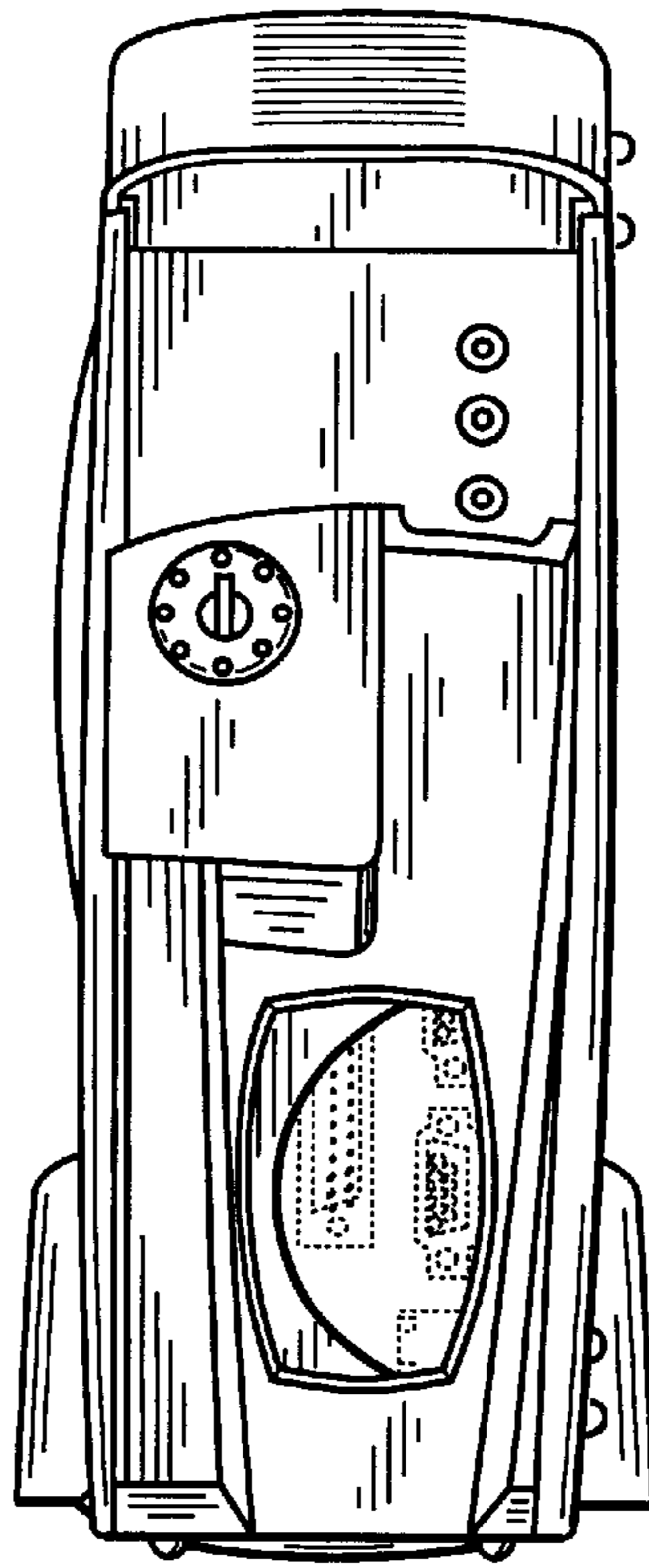

FIG. 5

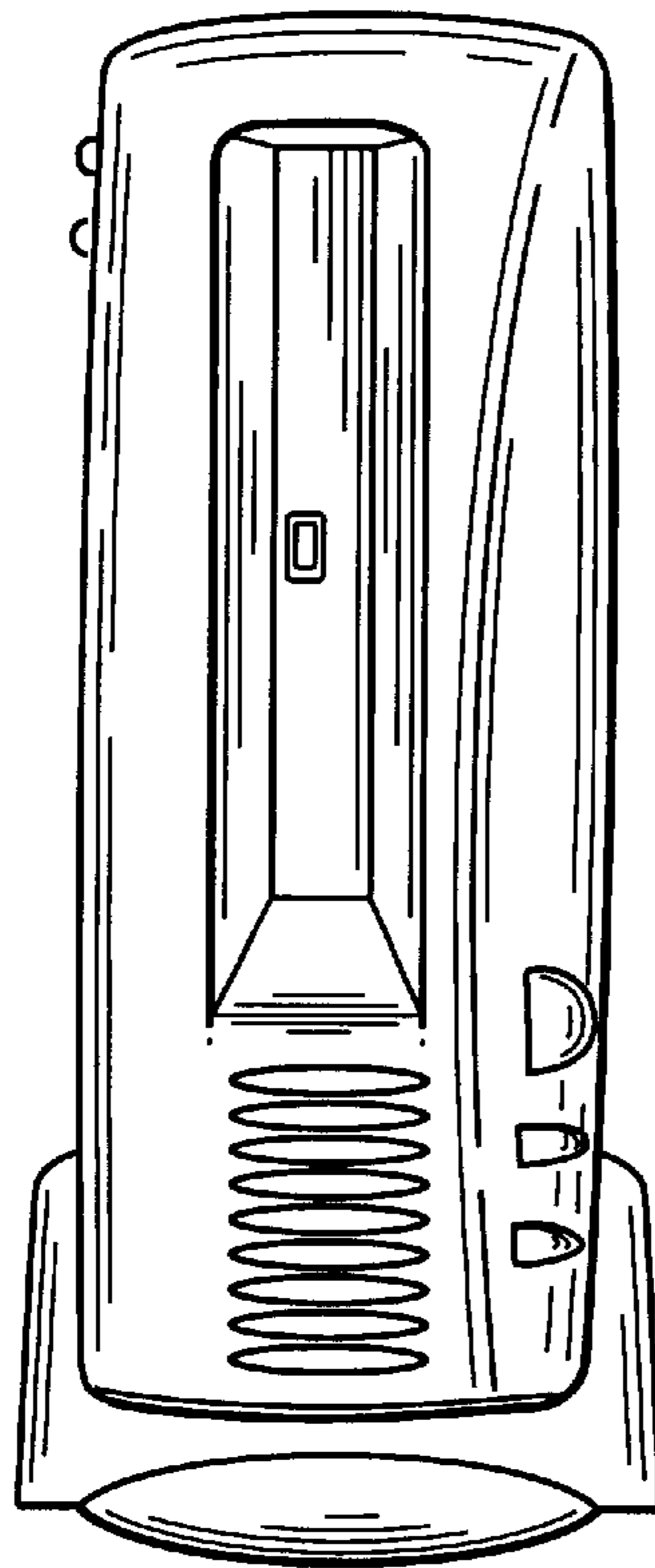

FIG. 6

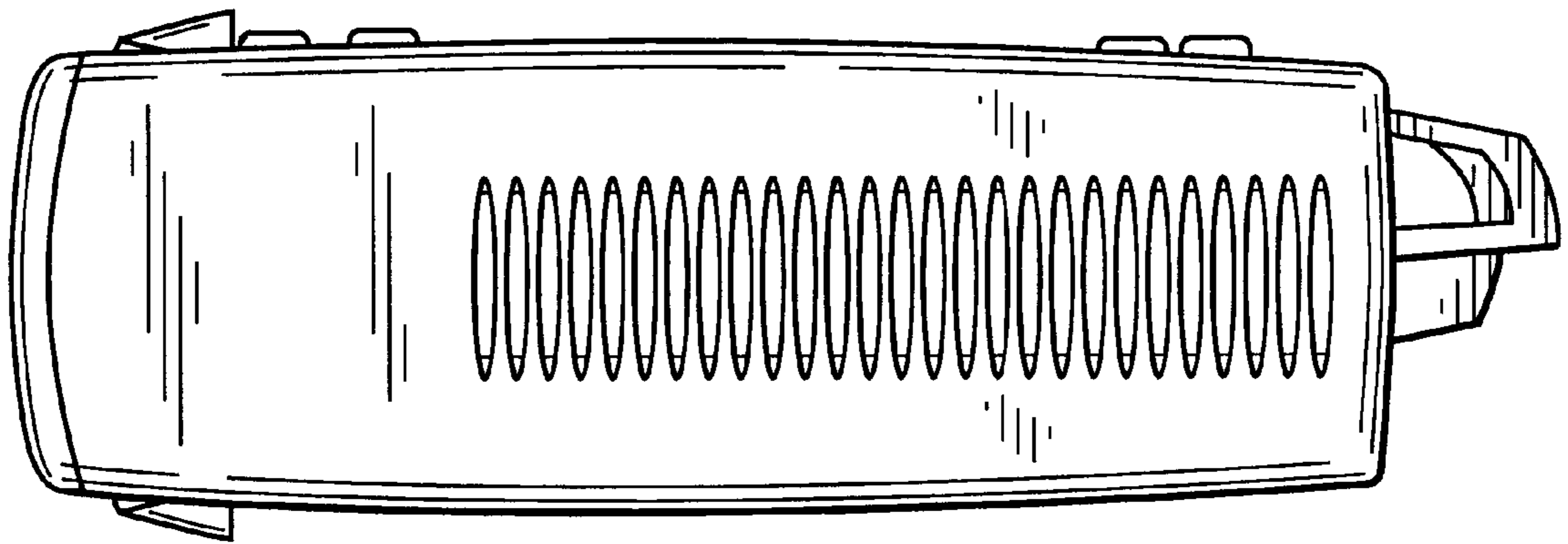

FIG. 7



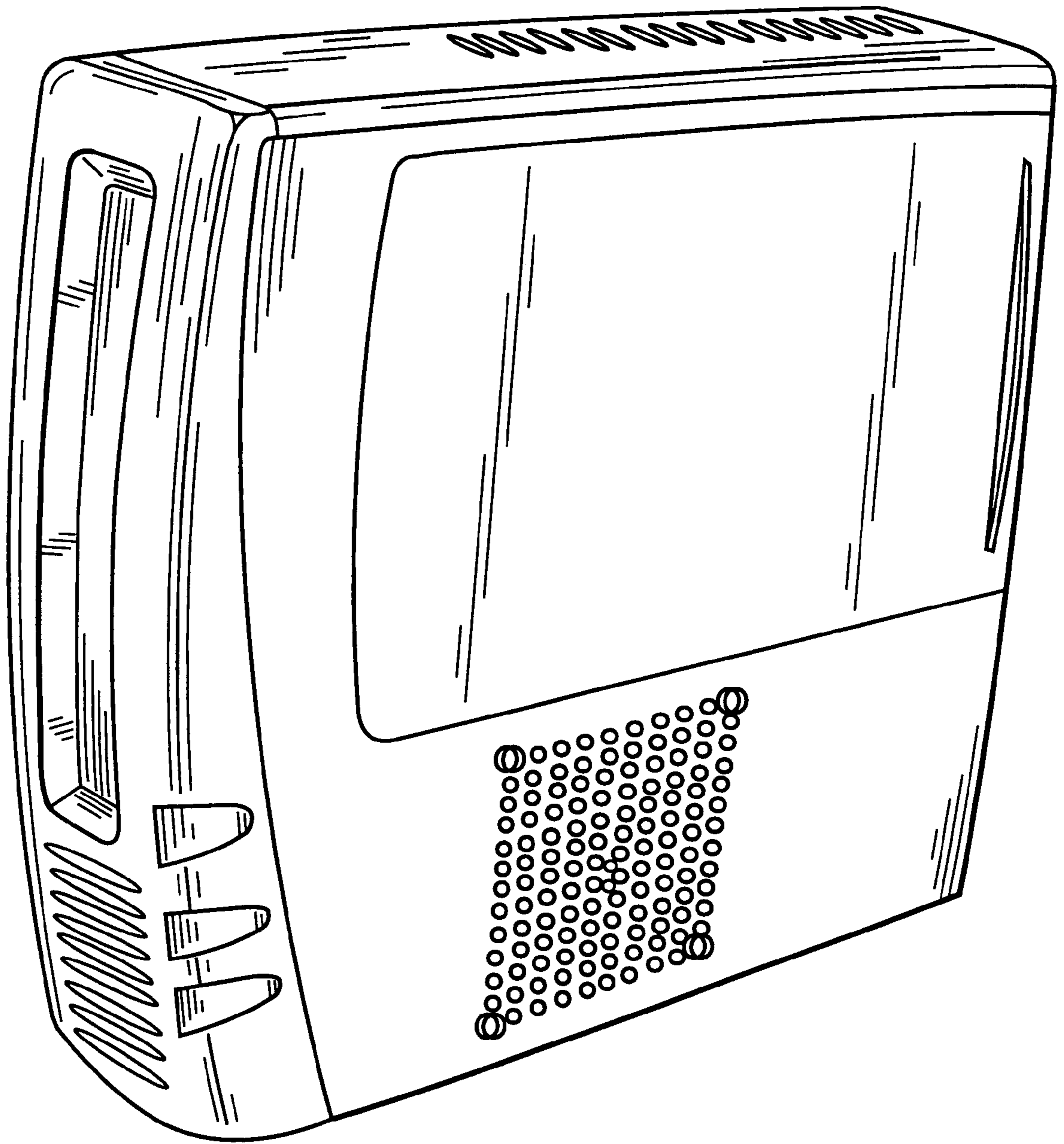

FIG. 8

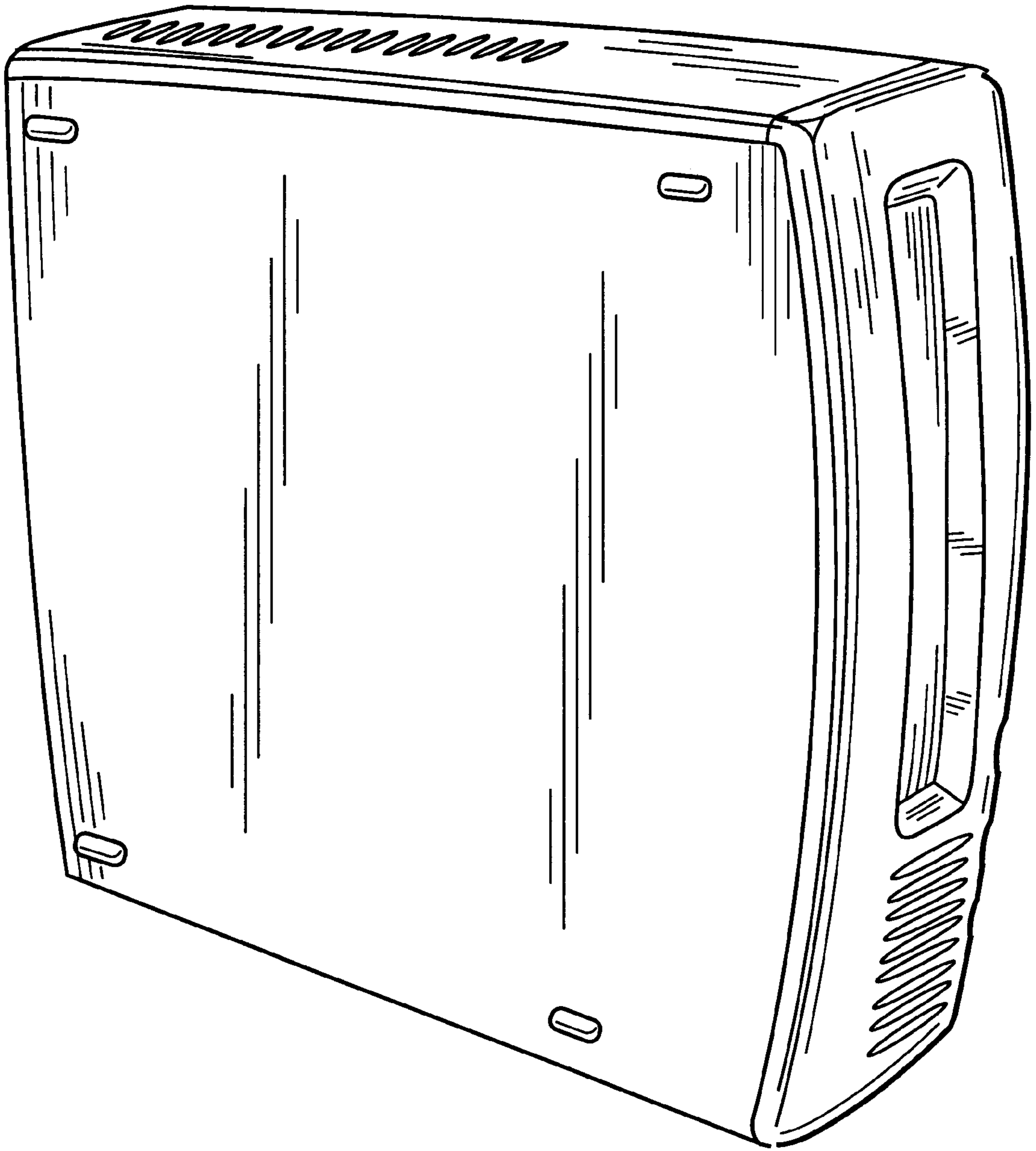

FIG. 9



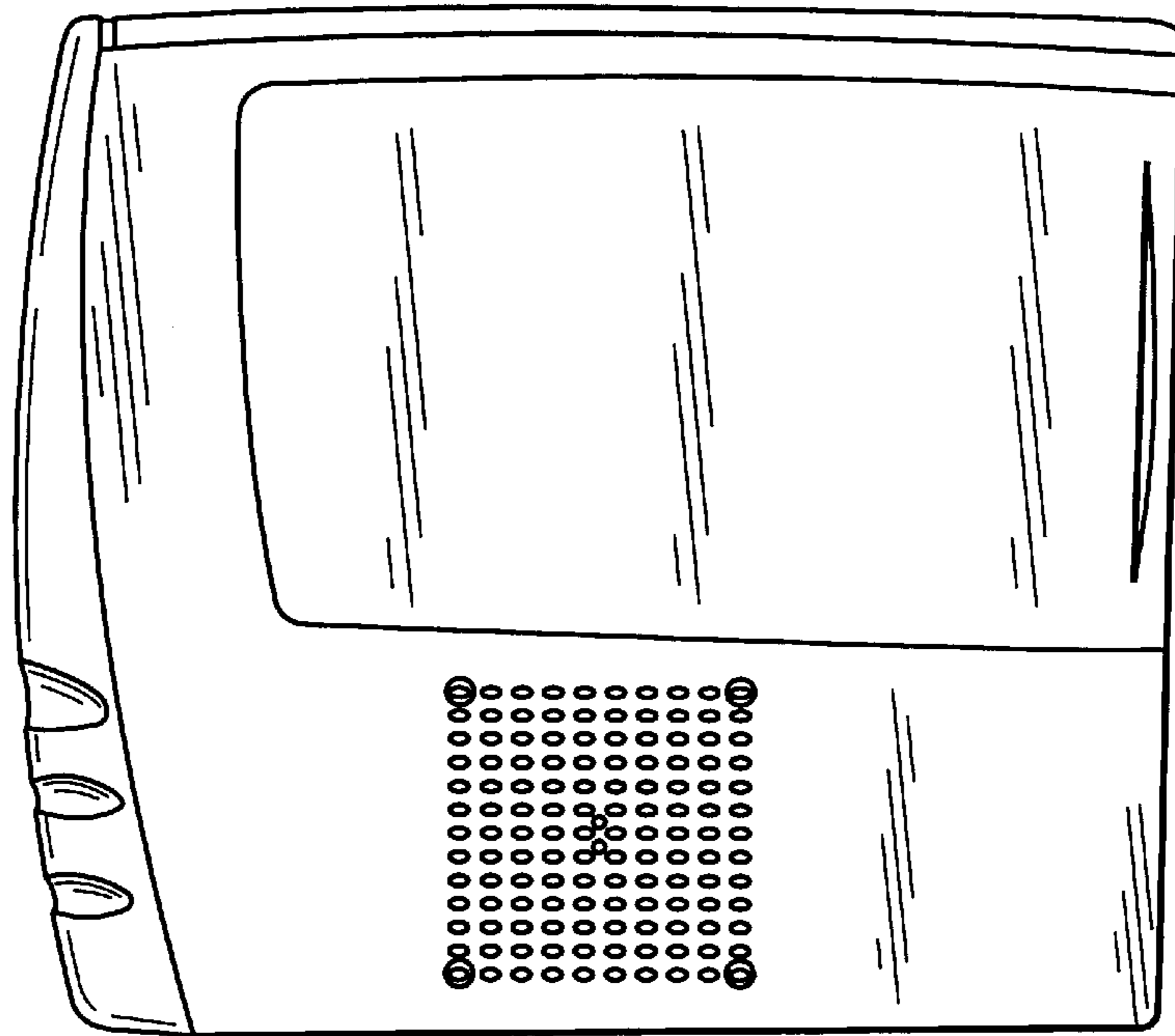

FIG. 10

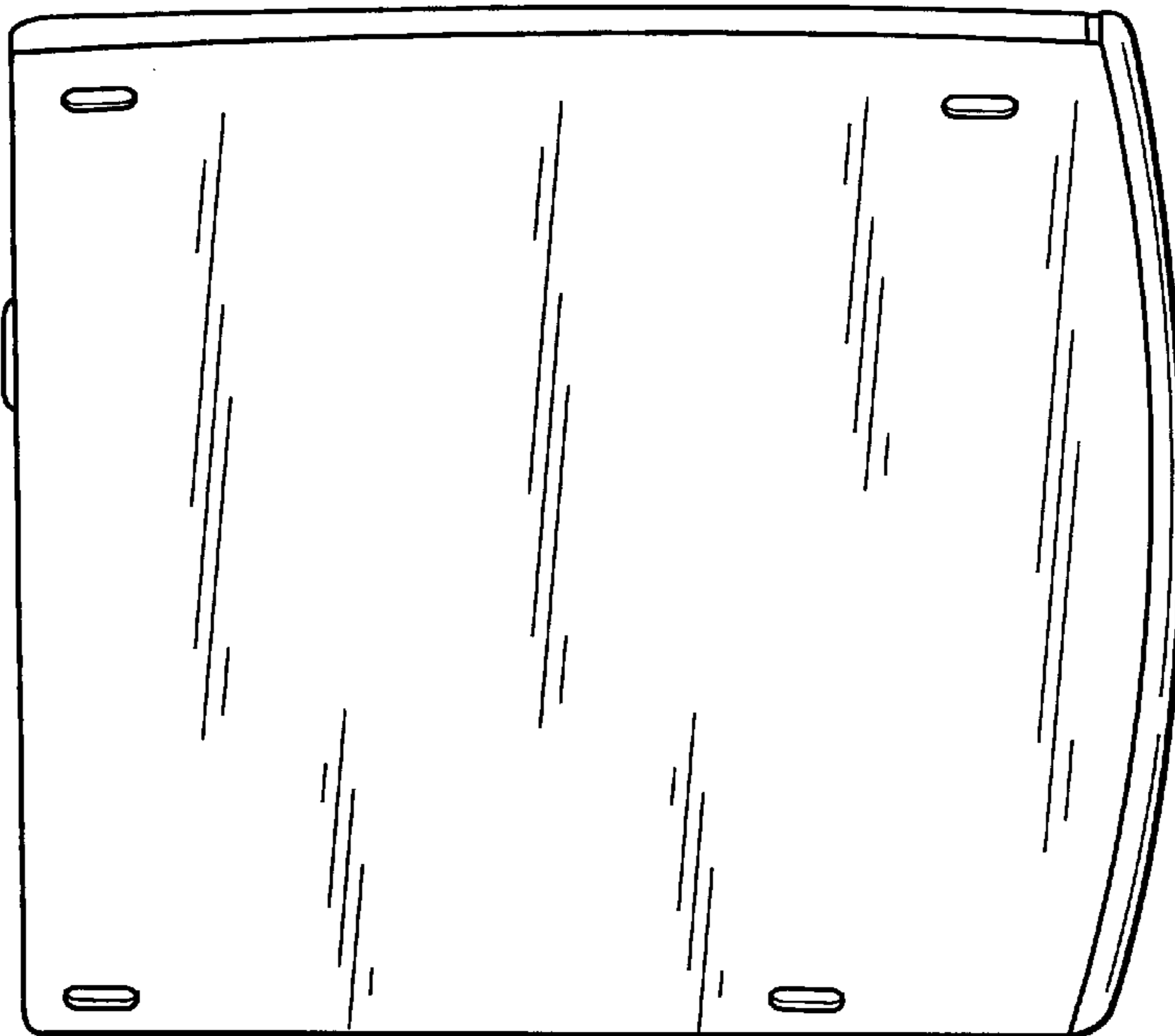

FIG. 11

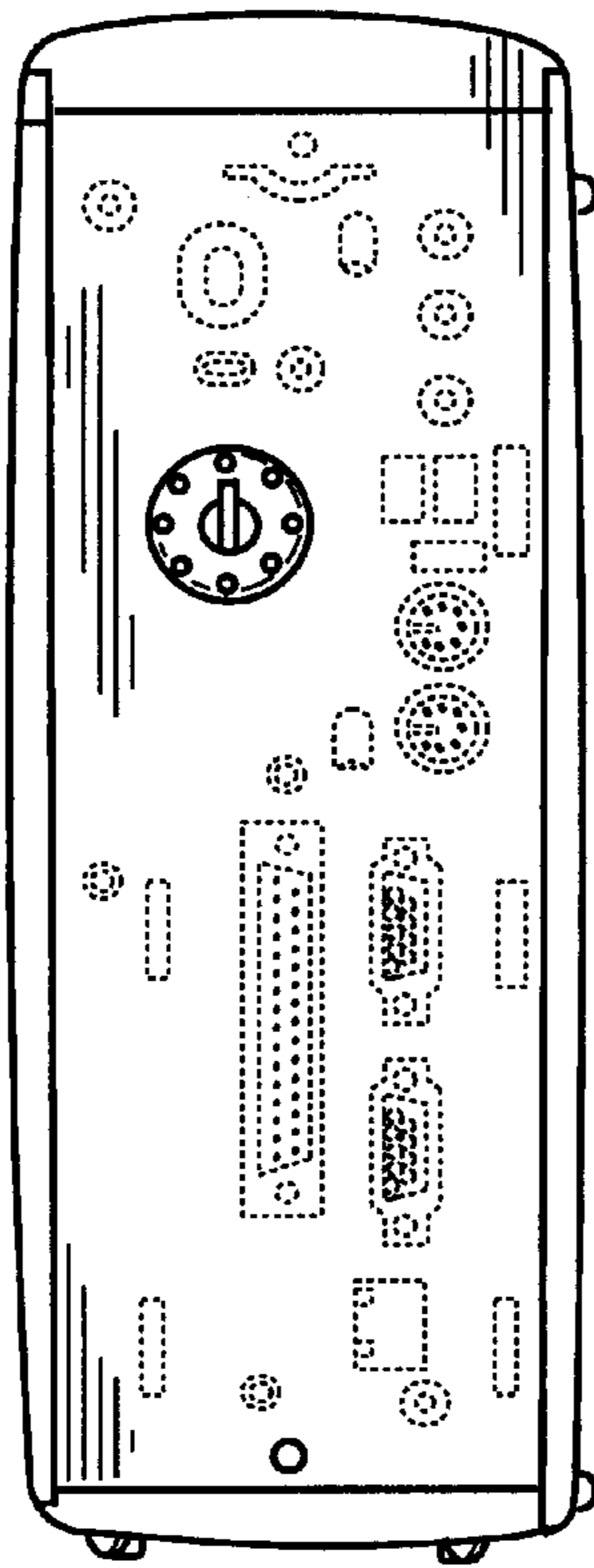

FIG. 12

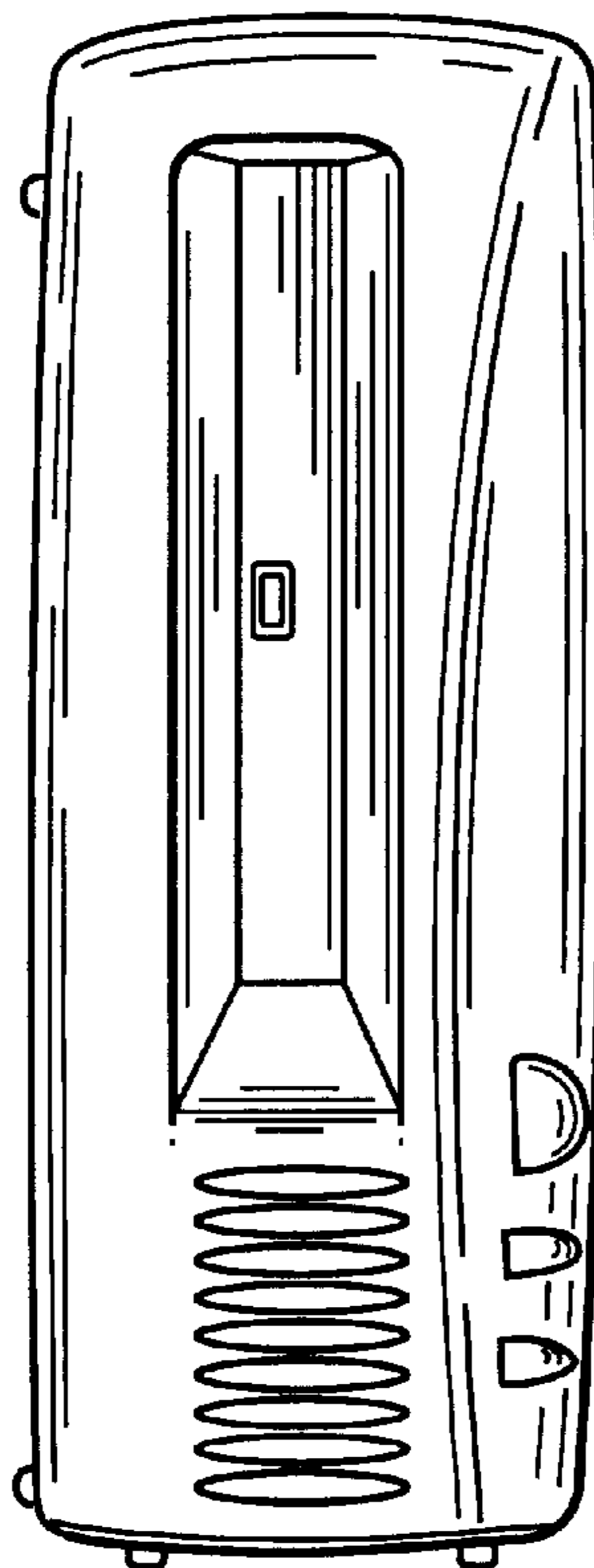

FIG. 13

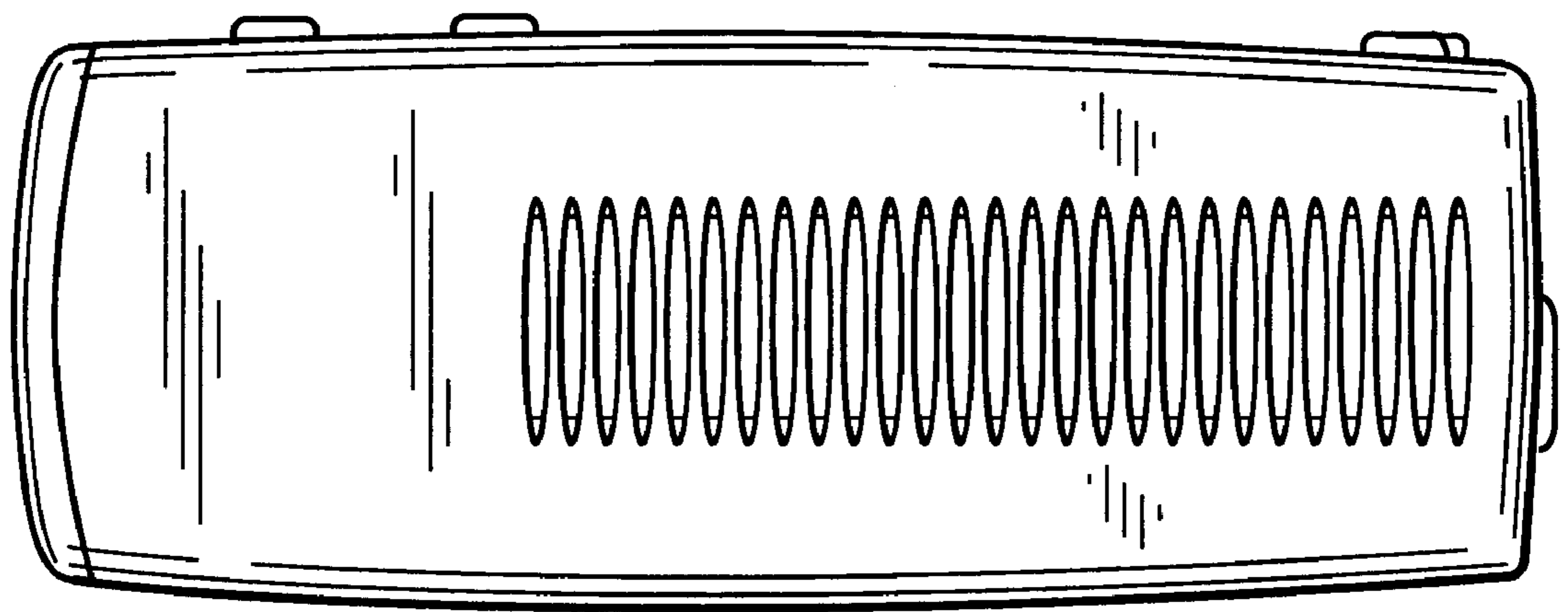

FIG. 14