



US00D447046B1

(12) **United States Design Patent**  
**Smith et al.**

(10) **Patent No.:** **US D447,046 S**

(45) **Date of Patent:** **\*\* Aug. 28, 2001**

(54) **GATE KEEPER FOR A SNAP HOOK**

(75) Inventors: **Keith A. Smith**, Burlington; **Steve B. Levay**, Font Hill; **Bob Claus**, Welland, all of (CA)

(73) Assignee: **Haun Drop Forge Co. Ltd.**, Welland (CA)

(\*\*) Term: **14 Years**

(21) Appl. No.: **29/122,455**

(22) Filed: **Apr. 28, 2000**

(51) **LOC (7) Cl.** ..... **08-05**

(52) **U.S. Cl.** ..... **D8/367**

(58) **Field of Search** ..... D8/367, 382; D34/35; 294/82.1, 82.11, 82.2; 24/599.8, 598.4, 599.5, 600.1, 600.2

(56) **References Cited**

**U.S. PATENT DOCUMENTS**

- D. 399,127 \* 10/1998 Messer ..... D8/367
- D. 407,300 \* 3/1999 Catlett ..... D8/367

**OTHER PUBLICATIONS**

Excerpts from Peninsula Safety Components Catalogue, Jan. 1999.

\* cited by examiner

*Primary Examiner*—Holly Baynham

(74) *Attorney, Agent, or Firm*—Merek & Voorhees

(57) **CLAIM**

The ornamental design for a gate keeper for a snap hook, as shown and described.

**DESCRIPTION**

FIG. 1 is a left side elevational view of the gate keeper for a snap hook;

FIG. 2 is a right side elevational view thereof;

FIG. 3 is a top plan view thereof;

FIG. 4 is a front elevational view thereof;

FIG. 5 is a rear elevational view thereof;

FIG. 6 is an environmental top plan view thereof; and,

FIG. 7 is an environmental side view thereof.

The broken lines shown in FIGS. 6 and 7 are for illustrative purposes only and form no part of the claimed design.

**1 Claim, 3 Drawing Sheets**

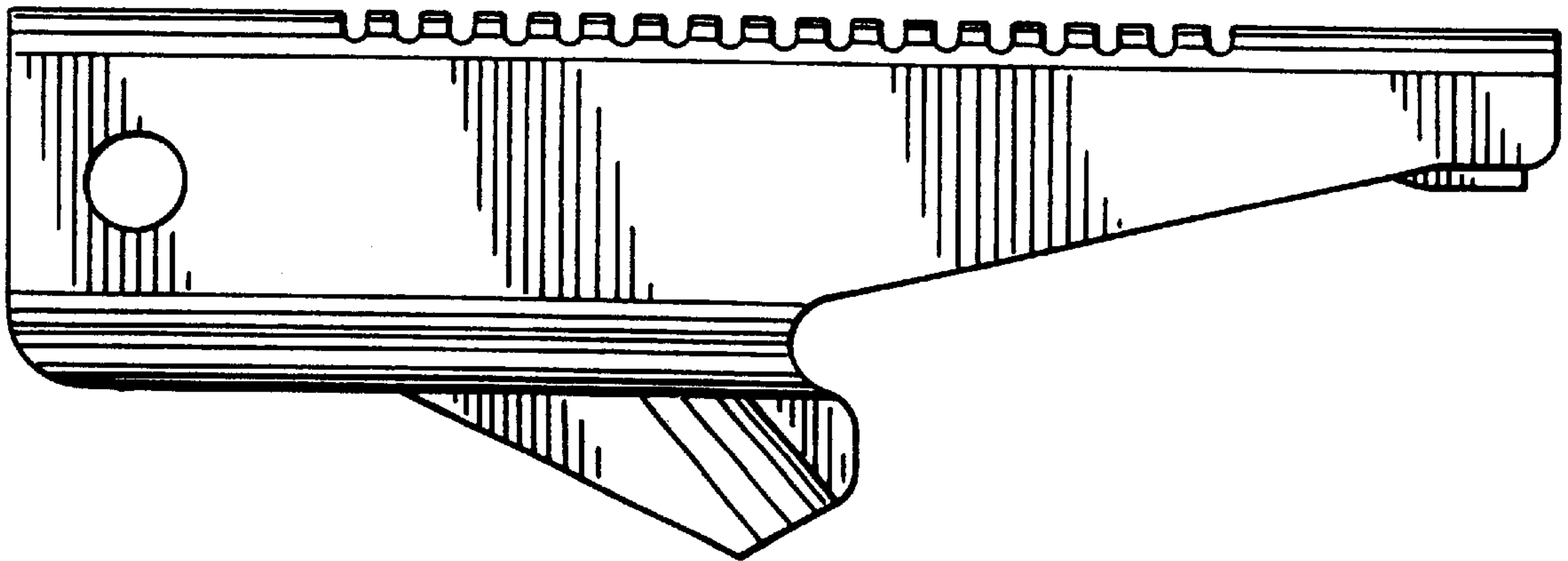

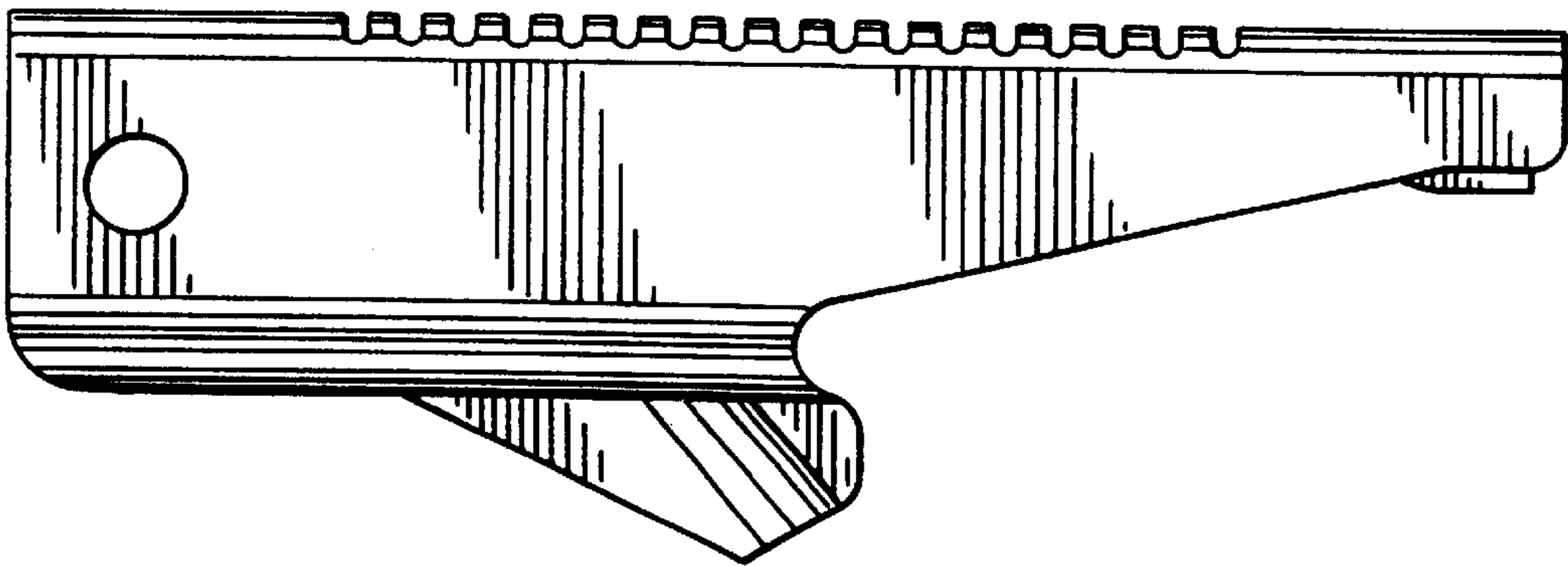

FIG. 1

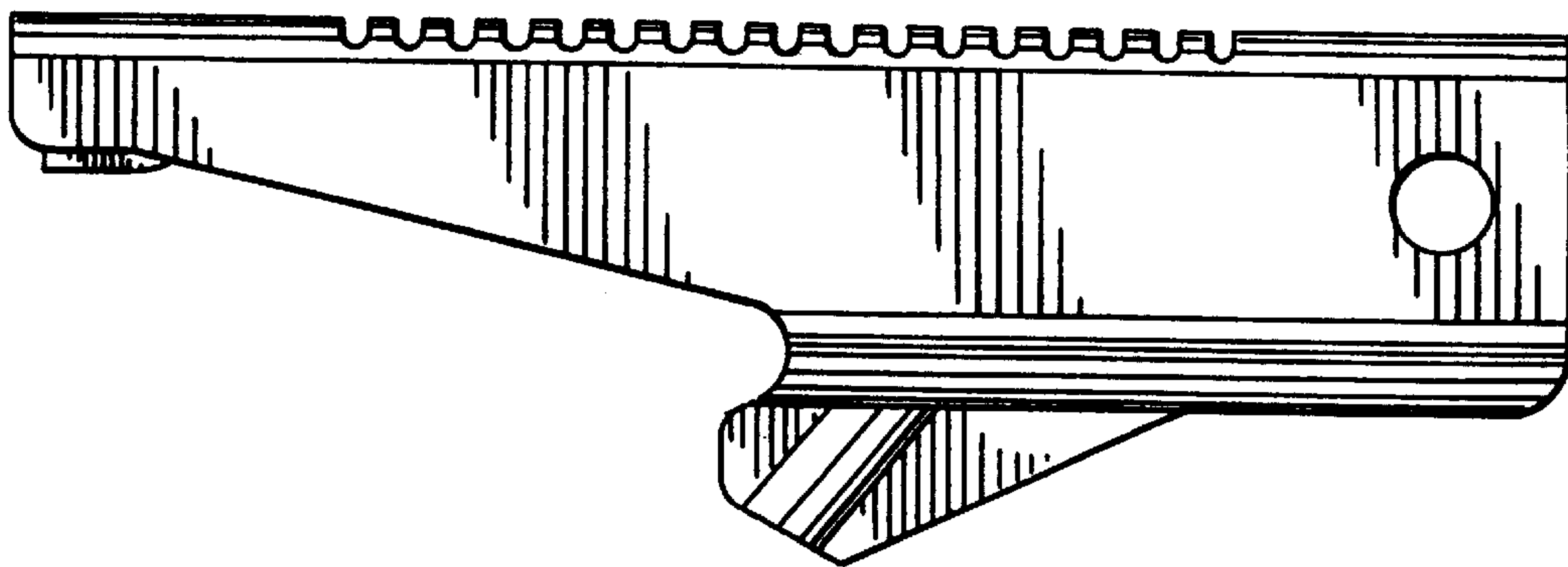

FIG. 2

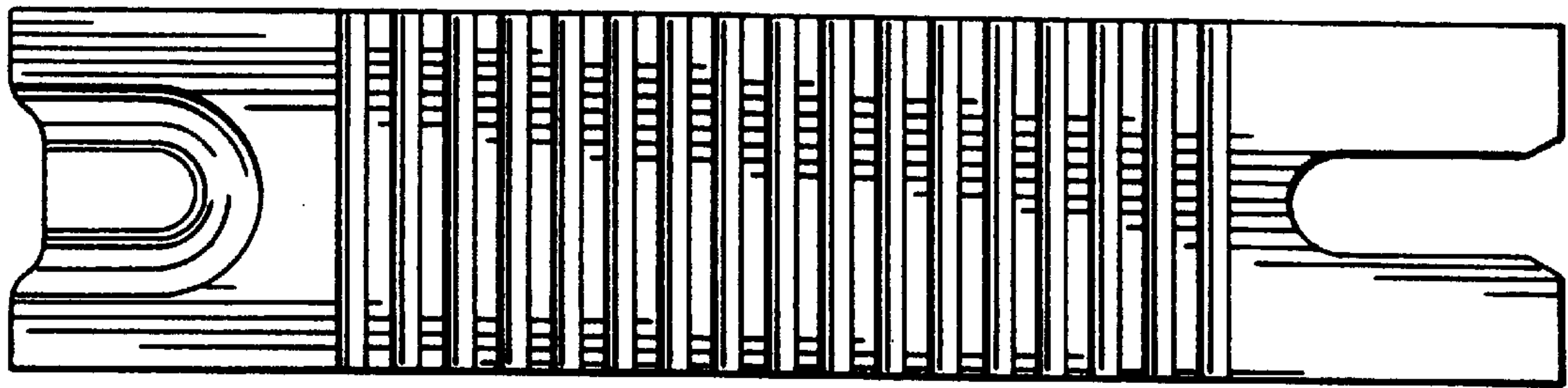

FIG. 3

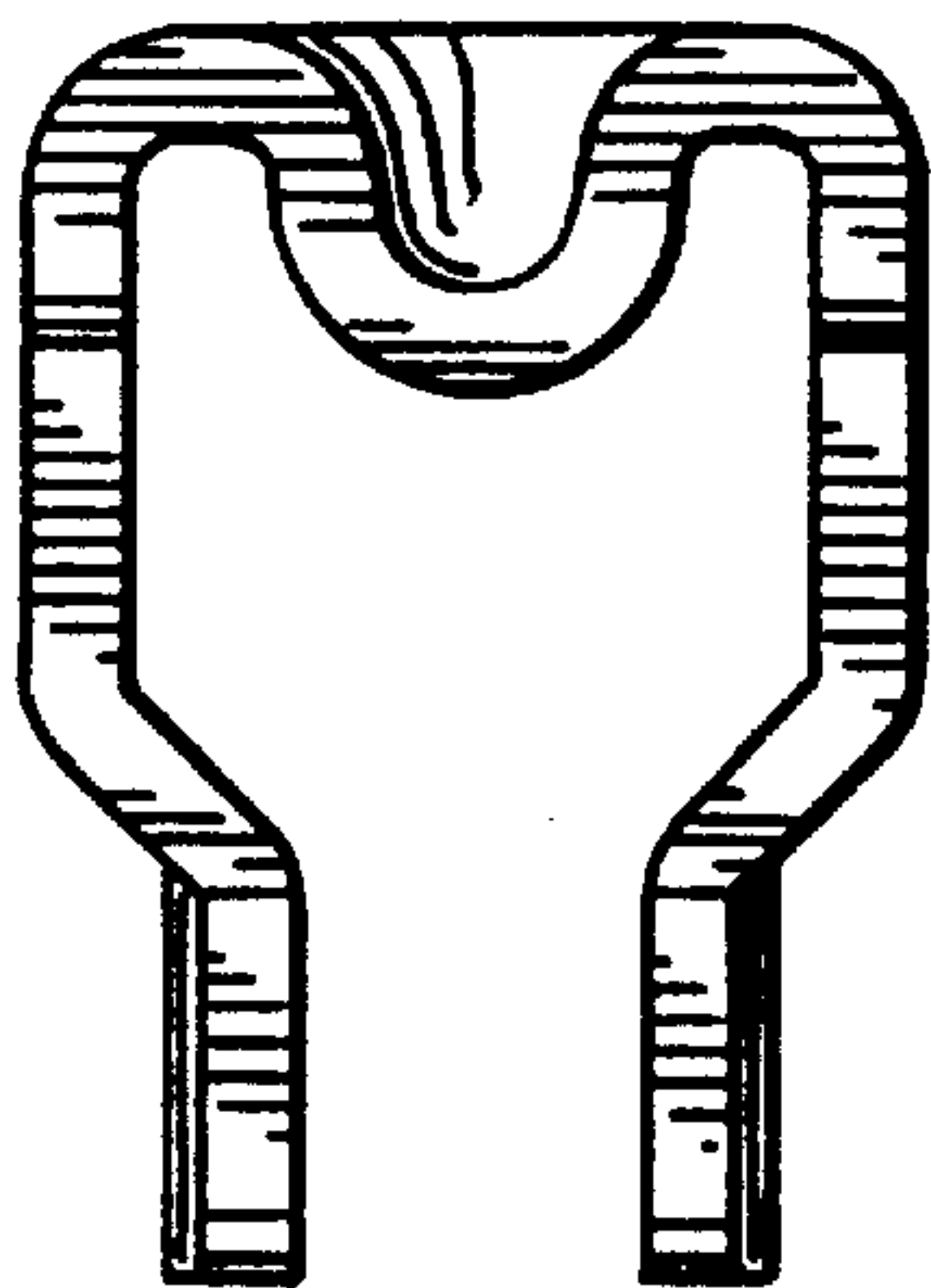

FIG. 4

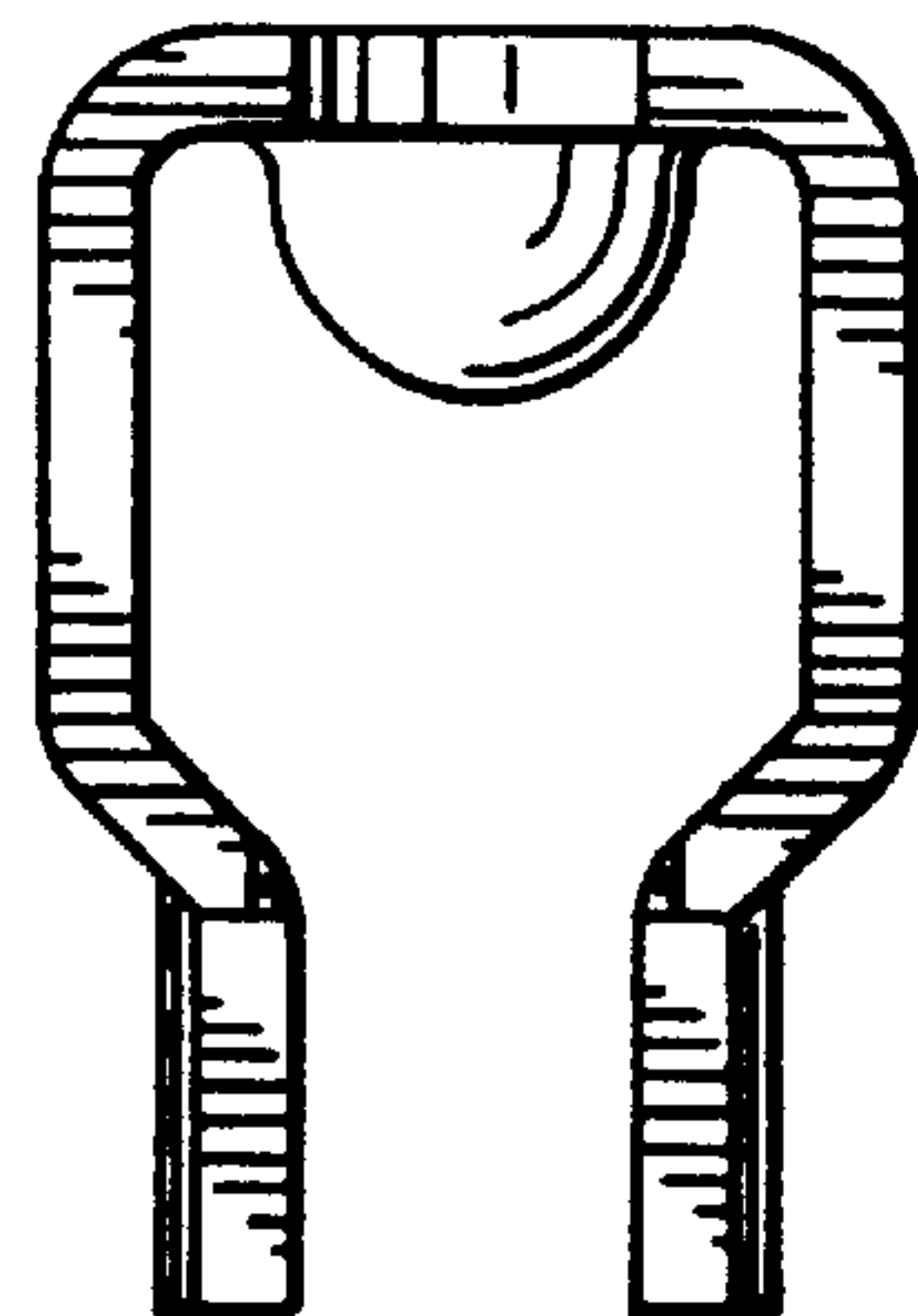

FIG. 5

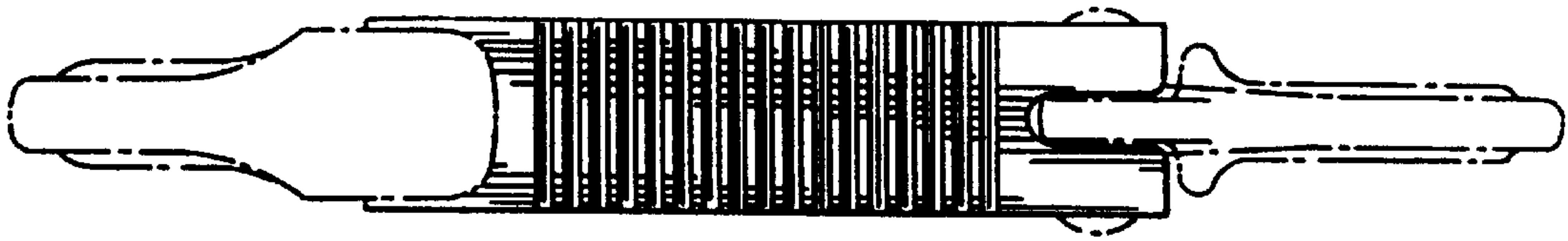

FIG. 6

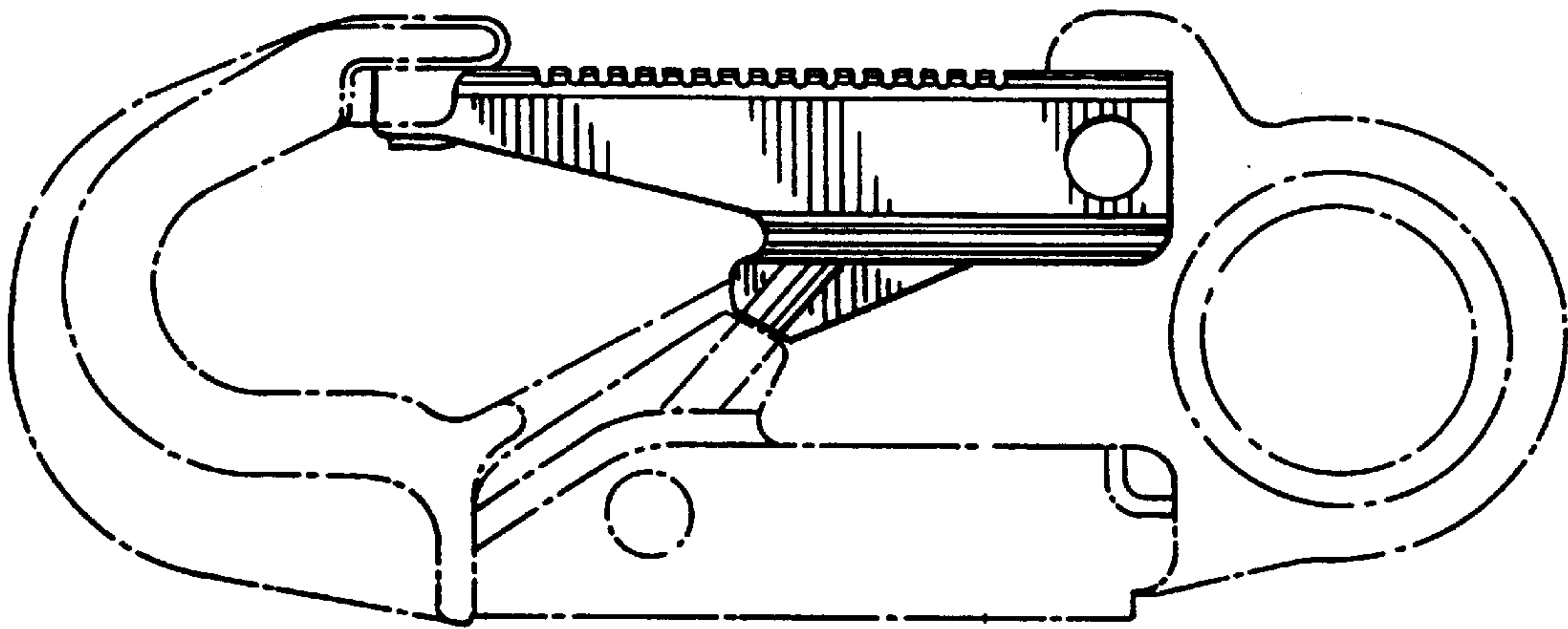

FIG. 7