



US00D447016B1

(12) **United States Design Patent**
Landström

(10) **Patent No.:** **US D447,016 S**

(45) **Date of Patent:** **** Aug. 28, 2001**

(54) **TEA STRAINER**

(76) Inventor: **Tomas Landström**, Lojovägen 45,
S—181 47 Lidingö(SE)

(**) Term: **14 Years**

(21) Appl. No.: **29/127,046**

(22) Filed: **Jul. 27, 2000**

(30) **Foreign Application Priority Data**

Jan. 31, 2000 (SE) 00-0173

(51) **LOC (7) Cl.** **07-04**

(52) **U.S. Cl.** **D7/668**

(58) **Field of Search** D7/665–668, 400;
99/323; 210/470; 426/77, 84

(56) **References Cited**

U.S. PATENT DOCUMENTS

1,601,613 * 9/1926 Fenyves 99/323

3,354,812 * 11/1967 Gorton, Jr. 99/323

5,967,019 * 10/1999 Johnson et al. 99/323

* cited by examiner

Primary Examiner—Terry A. Wallace

(74) *Attorney, Agent, or Firm*—Ostrolenk, Faber, Gerb &
Soffen, LLP

(57) **CLAIM**

The ornamental design for a tea strainer, as shown and described.

DESCRIPTION

FIG. 1 is a top, front right side perspective view of a tea strainer showing my new design;

FIG. 2 is a right side view thereof, the opposite left side view being a mirror image;

FIG. 3 is a top view thereof;

FIG. 4 is a bottom view thereof;

FIG. 5 is a left side view thereof;

FIG. 6 is a right side view thereof;

FIG. 7 is a perspective view thereof in an alternate condition; and,

FIG. 8 is a side view thereof in the alternate condition.

1 Claim, 4 Drawing Sheets

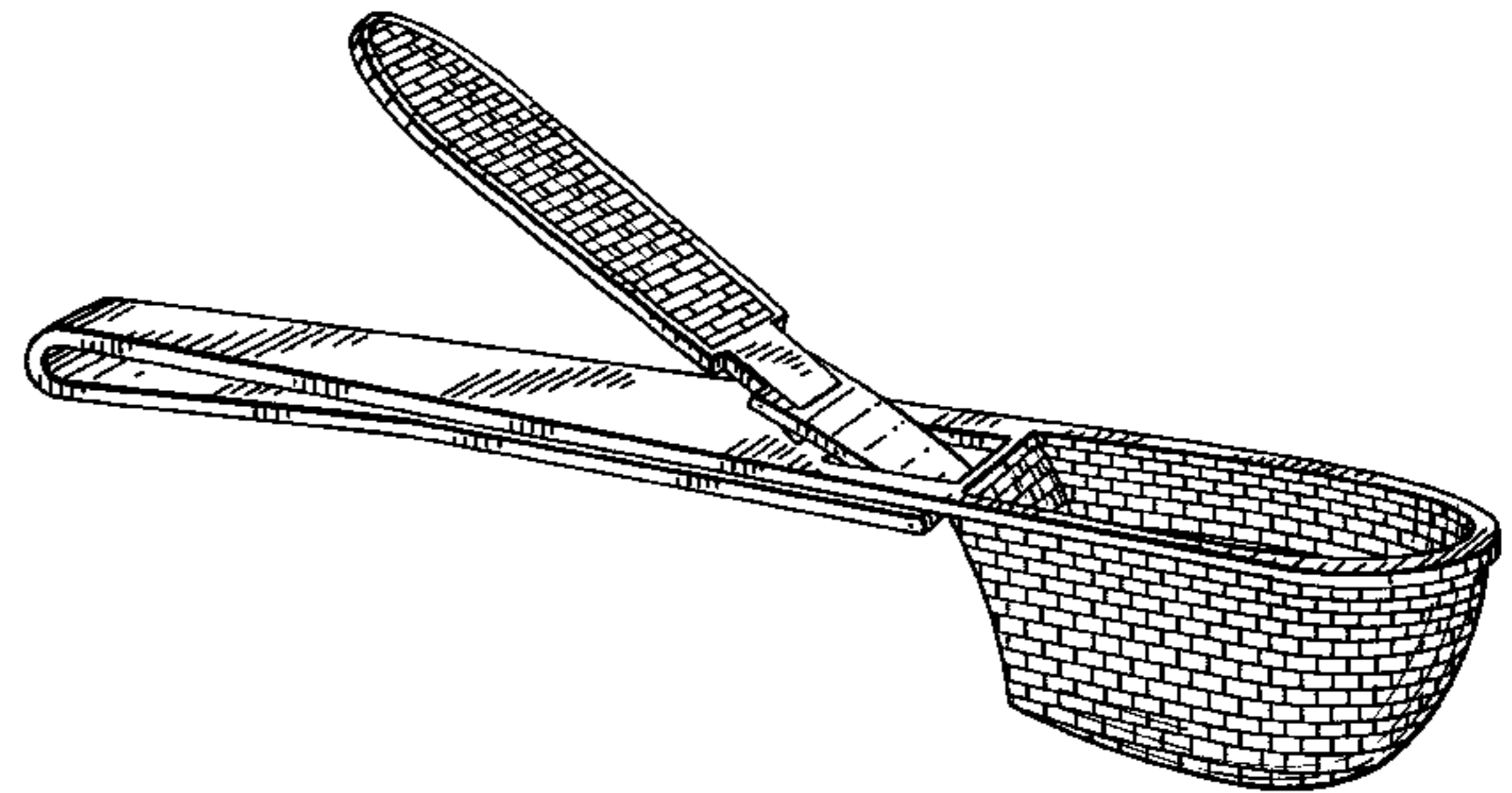
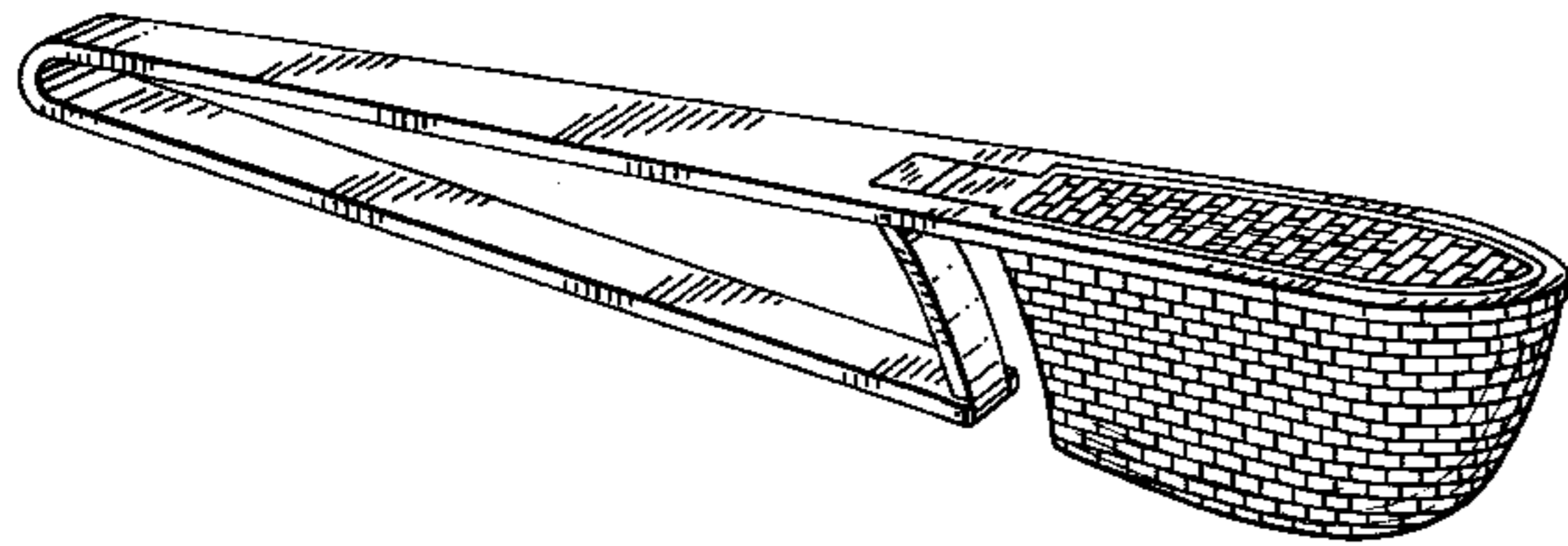

FIG. 1

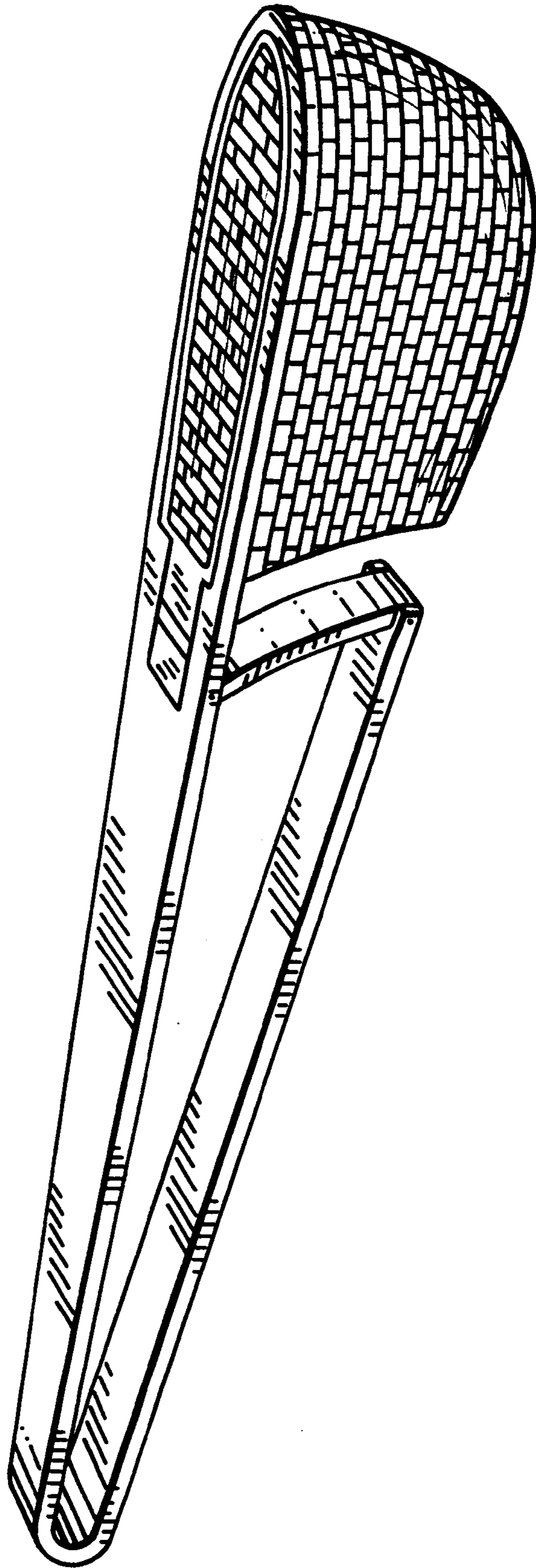

FIG. 3

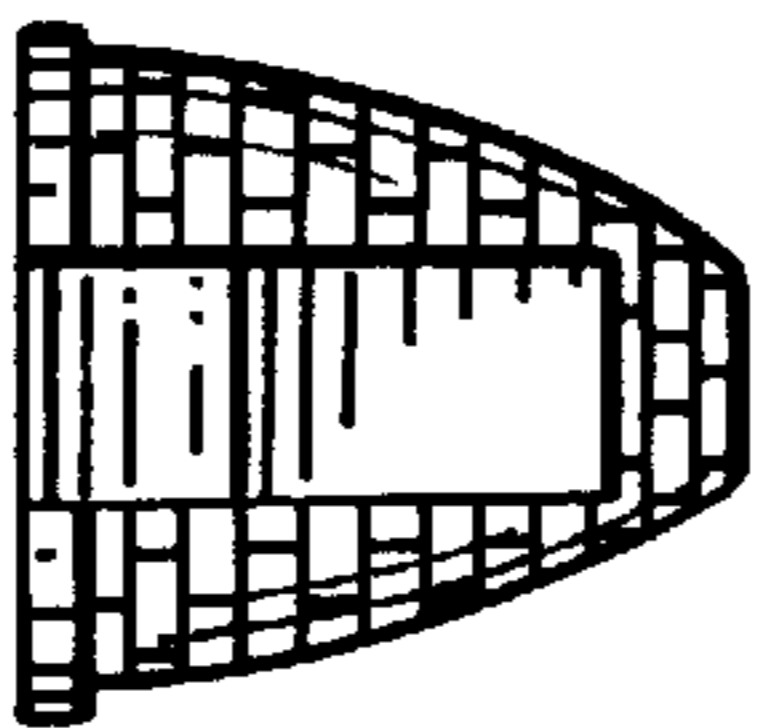
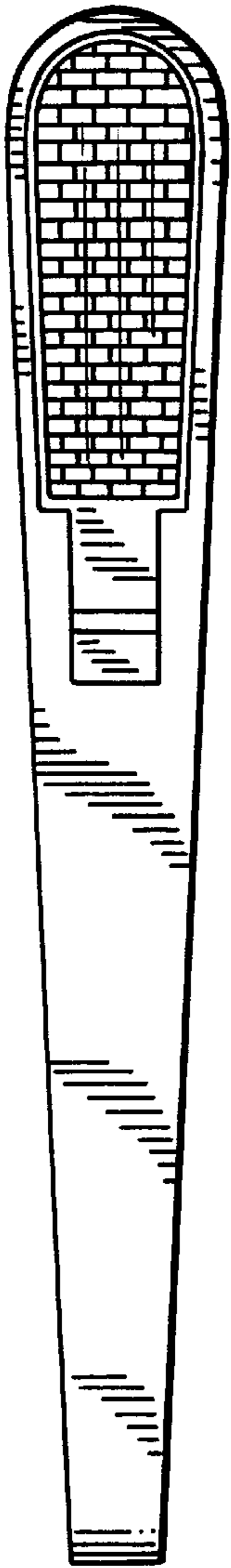

FIG. 5

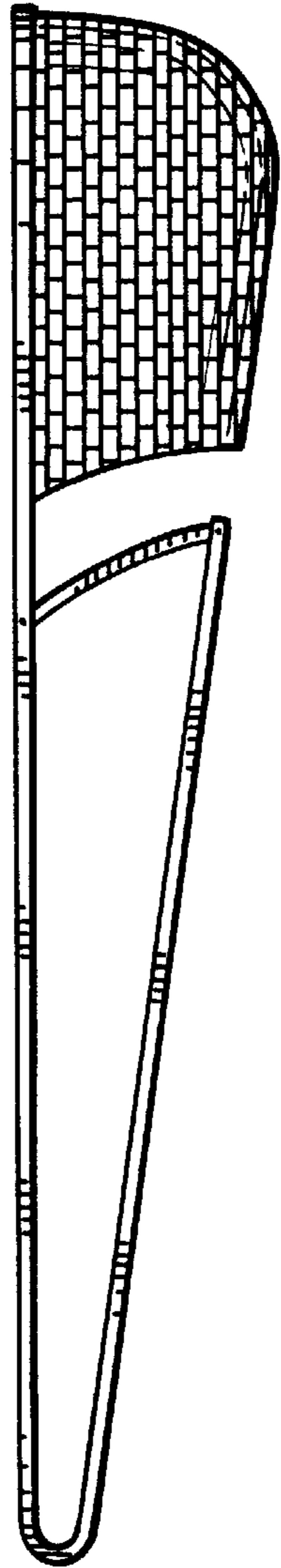

FIG. 2

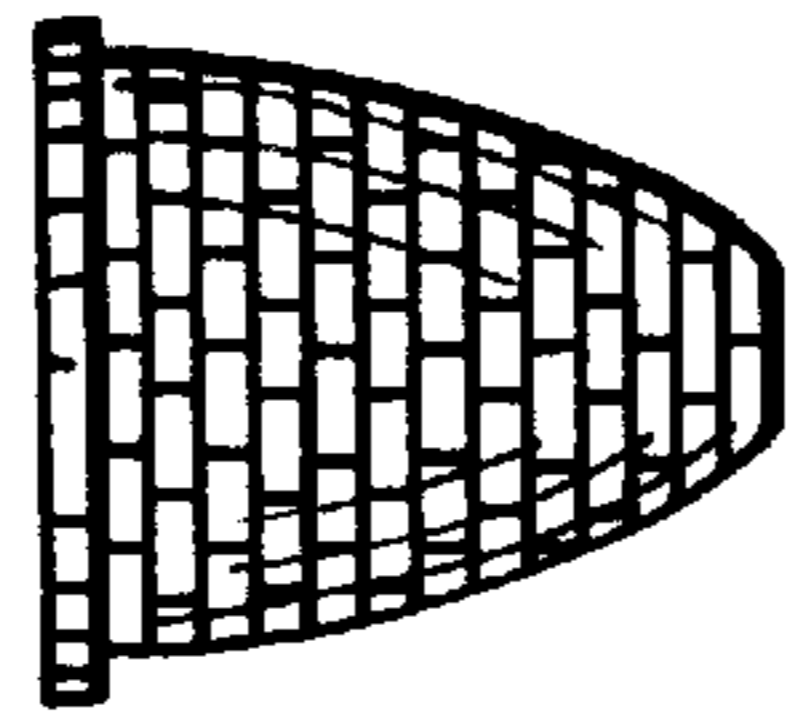

FIG. 6

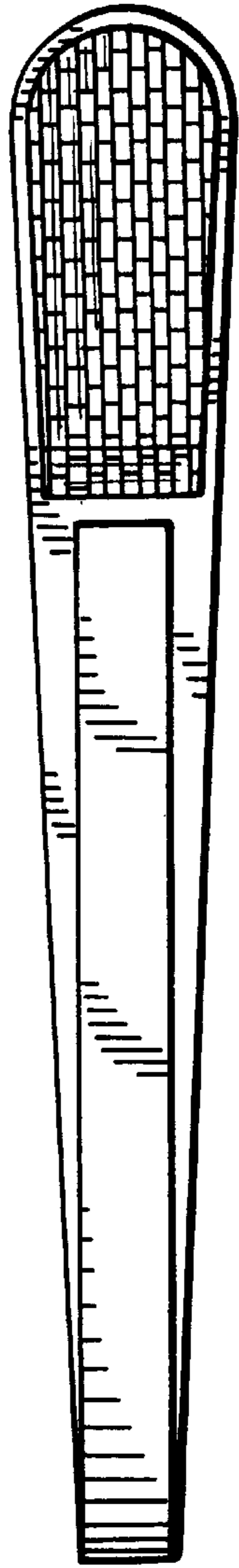
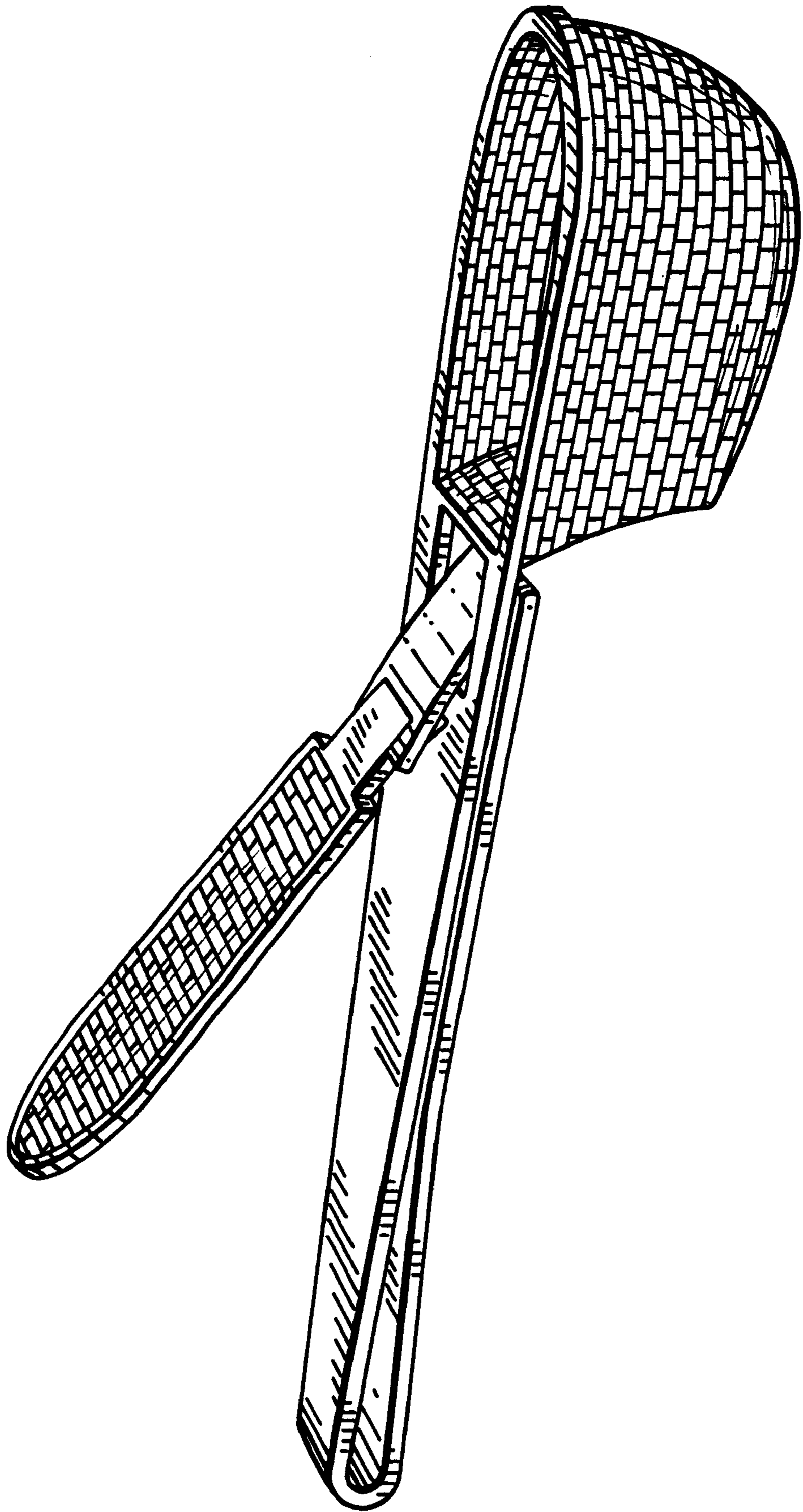

FIG. 4

FIG. 7



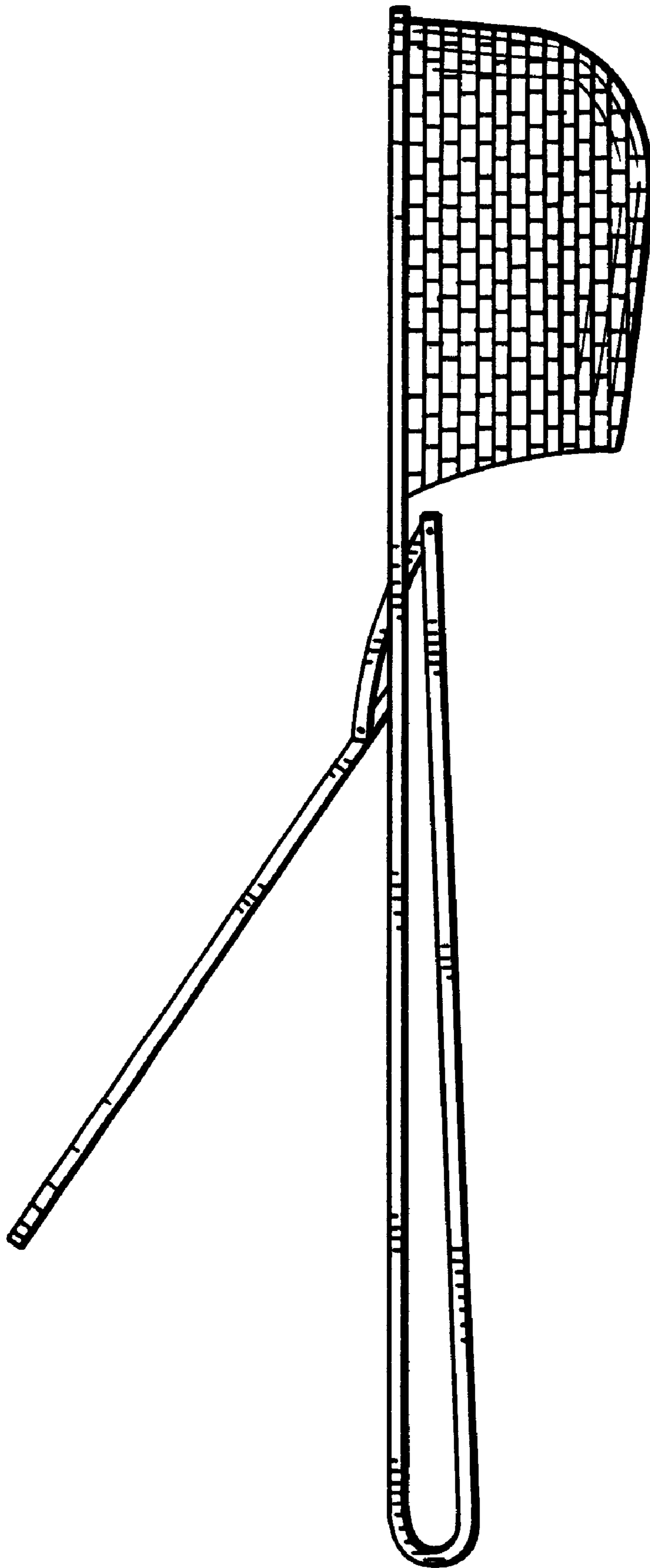

FIG. 8