



US00D446909B1

(12) **United States Design Patent**
Colbert et al.

(10) **Patent No.:** **US D446,909 S**

(45) **Date of Patent:** **** Aug. 28, 2001**

(54) **CAP**

5,169,193 * 12/1992 Stelmach 294/65.5

6,035,449 * 3/2000 Gaur et al. 24/303 X

6,112,332 * 9/2000 McCormick 2/181

(75) Inventors: **Agatha P. Colbert**, Newton; **Deborah Risotti**, N. Reading, both of MA (US)

* cited by examiner

(73) Assignee: **Deborah J. Risotti**, North Reading, MA (US)

Primary Examiner—Paula A. Mortimer

(74) *Attorney, Agent, or Firm*—Jeanne M. Carroll Agent

(**) Term: **14 Years**

(57) **CLAIM**

(21) Appl. No.: **29/131,748**

The ornamental design for a cap, as shown and described.

(22) Filed: **Oct. 25, 2000**

DESCRIPTION

(51) **LOC (7) Cl.** **02-03**

FIG. 1 is a perspective view of a cap showing our new design;

(52) **U.S. Cl.** **D2/891; D2/882**

FIG. 2 is a left side elevation view thereof;

(58) **Field of Search** D2/865, 866, 872,

FIG. 3 is a right side elevation view thereof;

D2/876, 879, 882, 884, 891, 892; 2/171,

FIG. 4 is a front view thereof;

181, 191.1, 209.11, 249, 250, 255, 256,

FIG. 5 is a rear view thereof;

260; D13/183; D24/191, 200; 294/65.5;

FIG. 6 is a top view thereof; and,

24/303

FIG. 7 is a bottom view thereof.

(56) **References Cited**

The broken line showing of the cap in all views is for illustrative purposes only and forms no part of the claimed design.

U.S. PATENT DOCUMENTS

D. 23,944 * 1/1895 Pearson D2/891

1 Claim, 3 Drawing Sheets

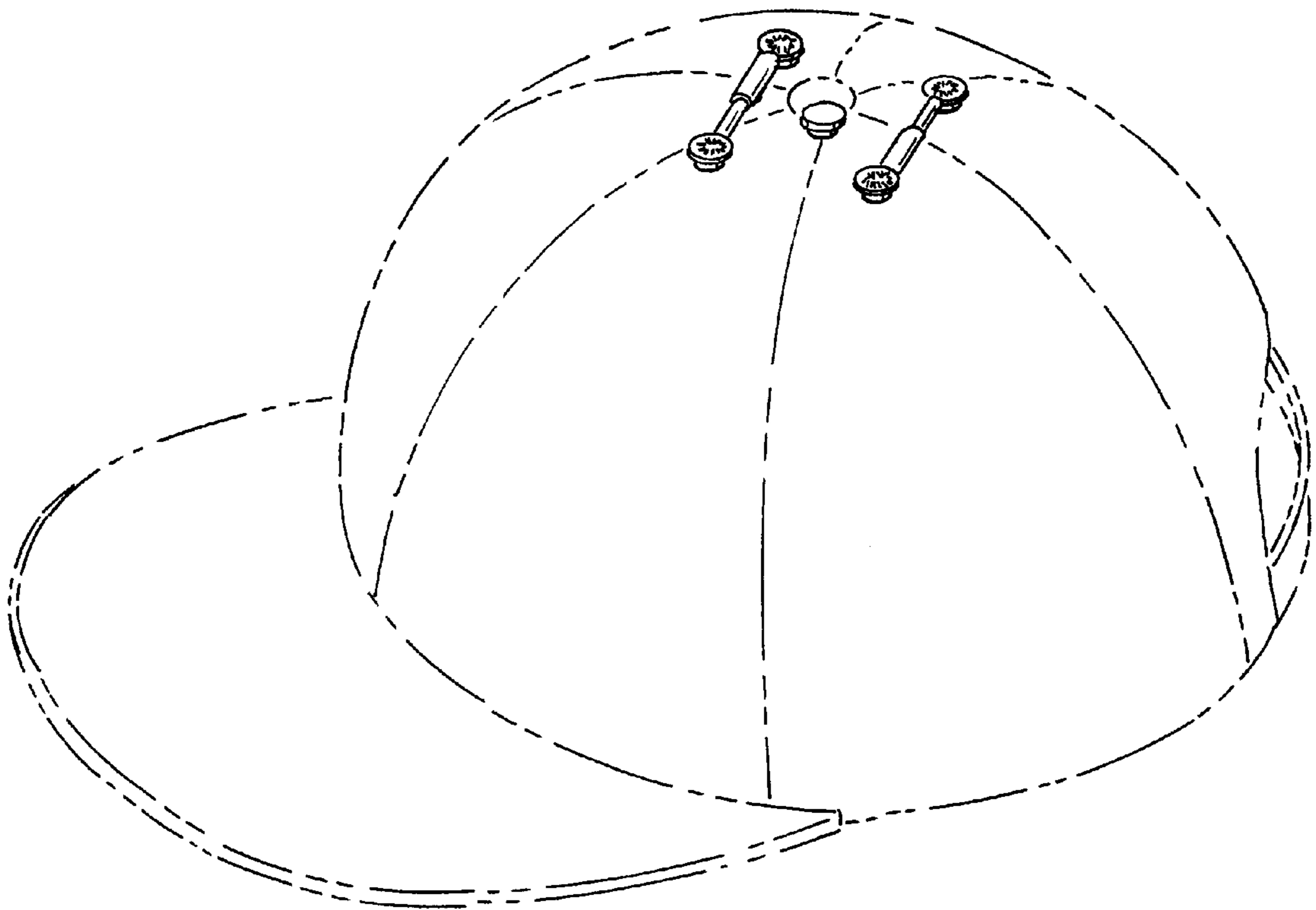

FIG. 1

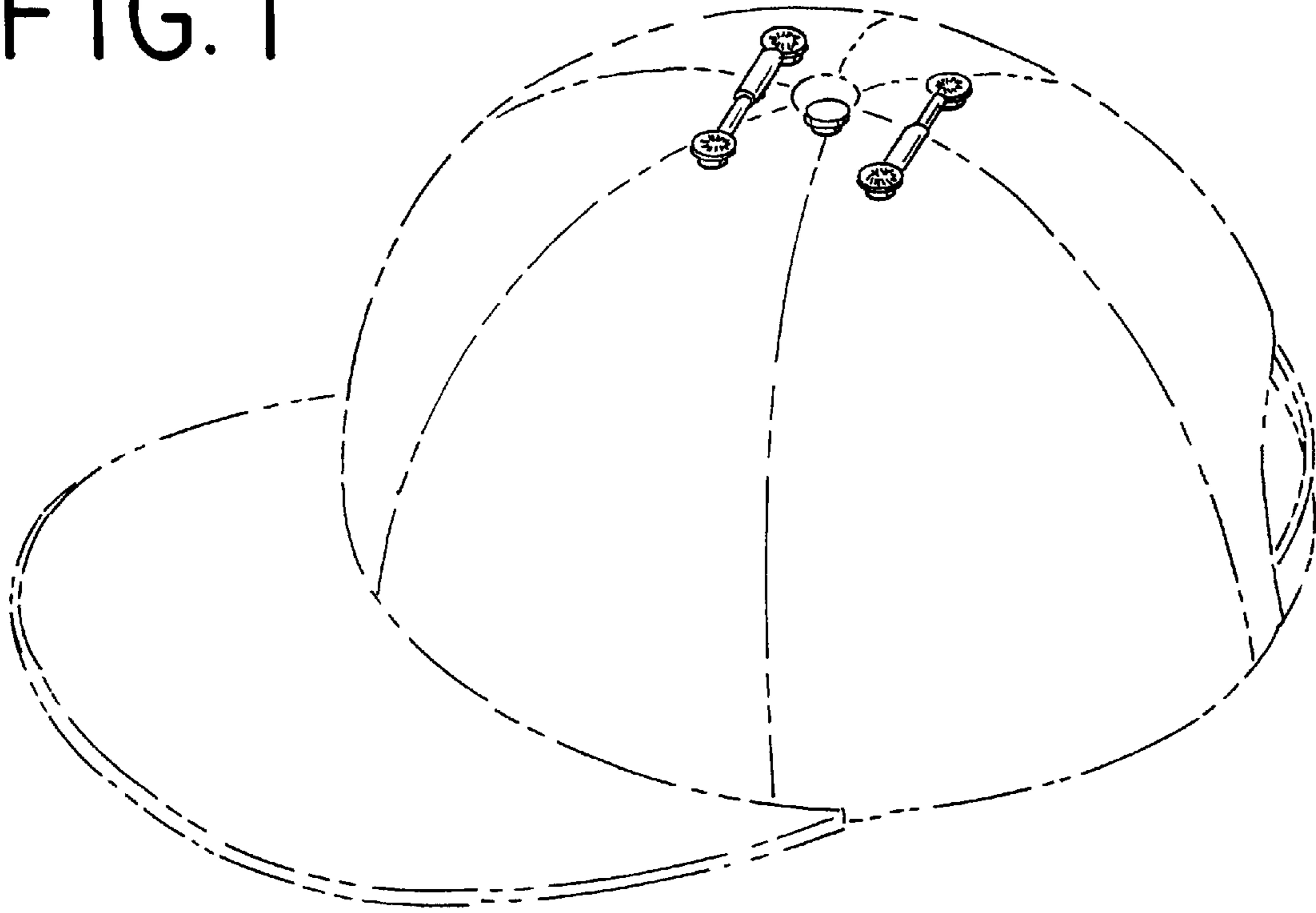
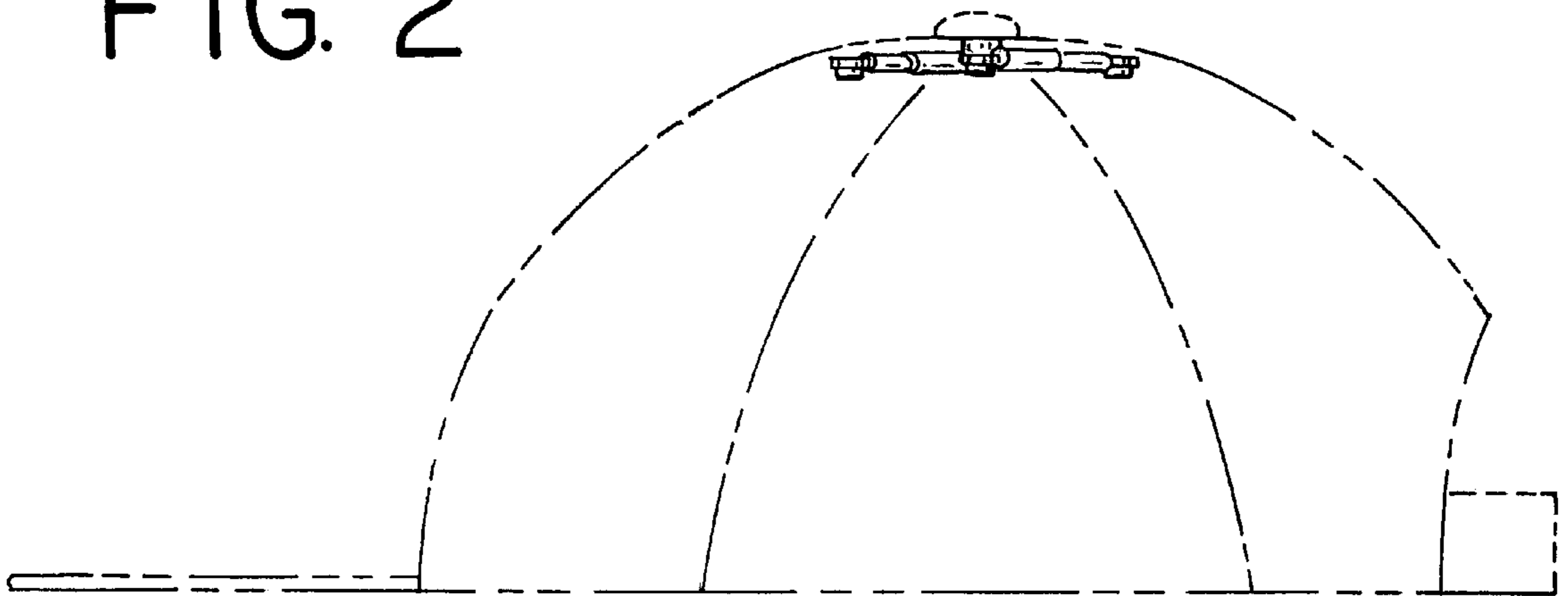

FIG. 2



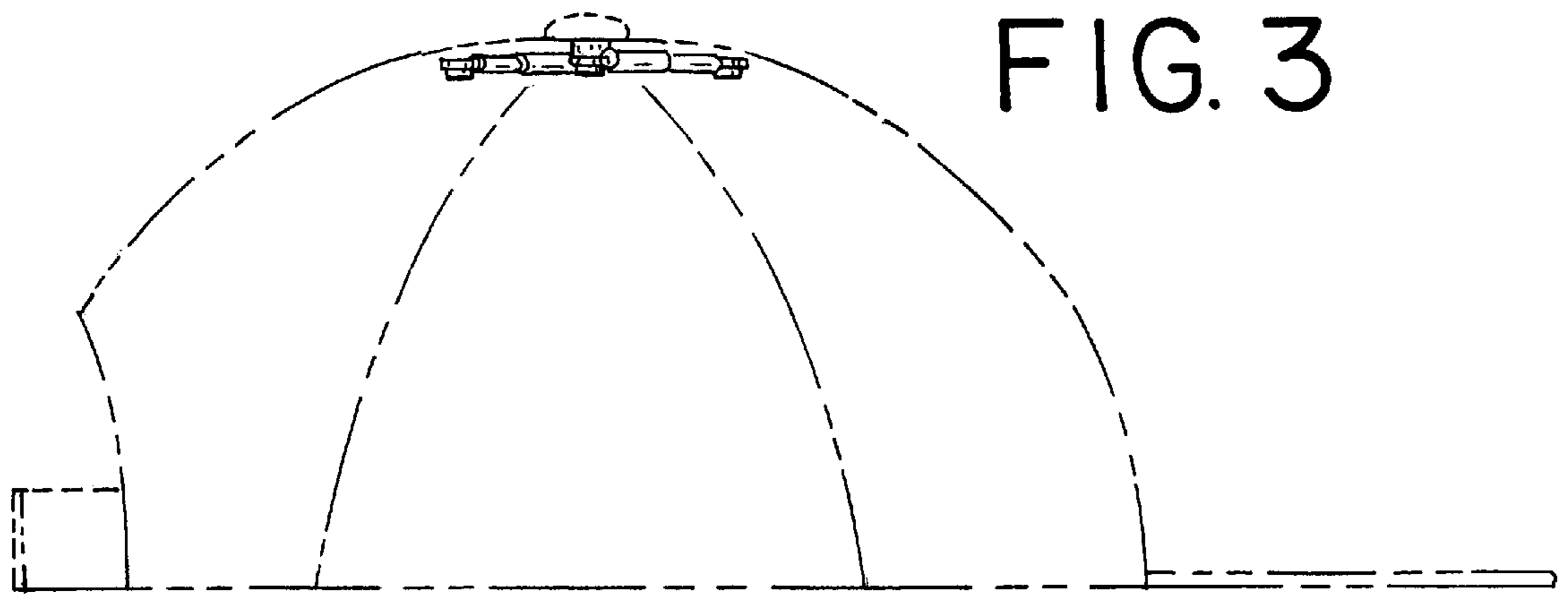

FIG. 4

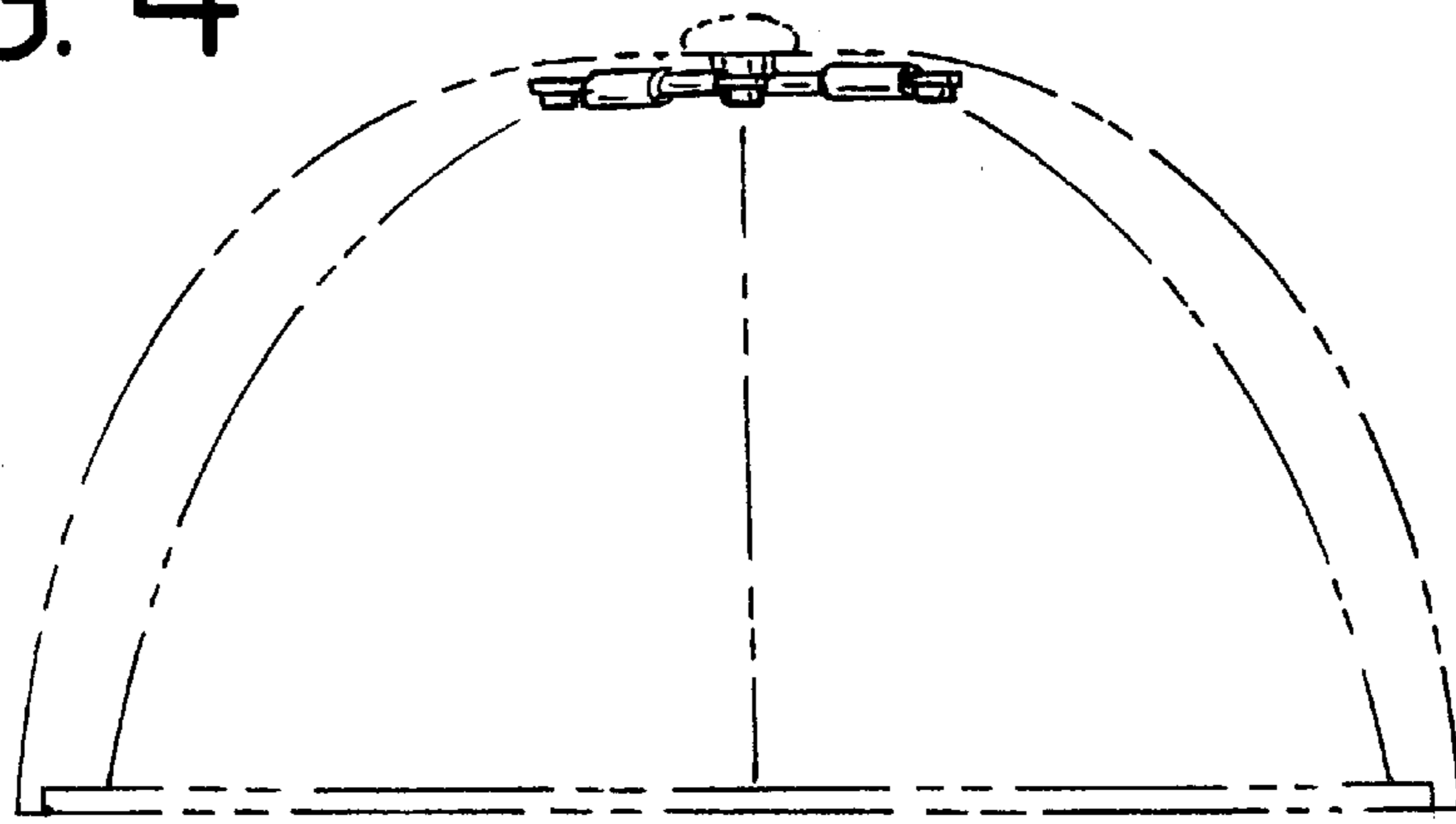

FIG. 5

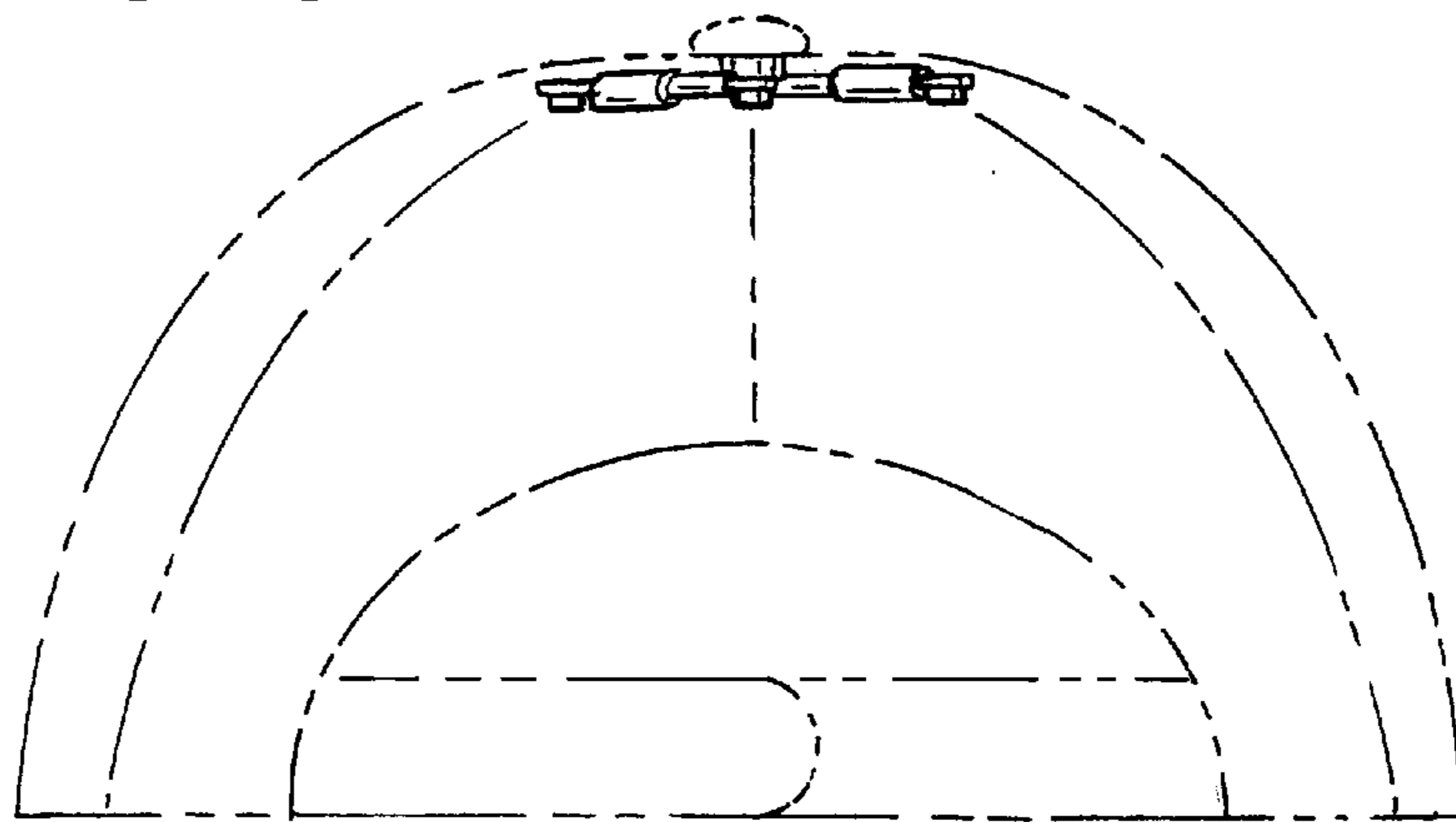

FIG. 6

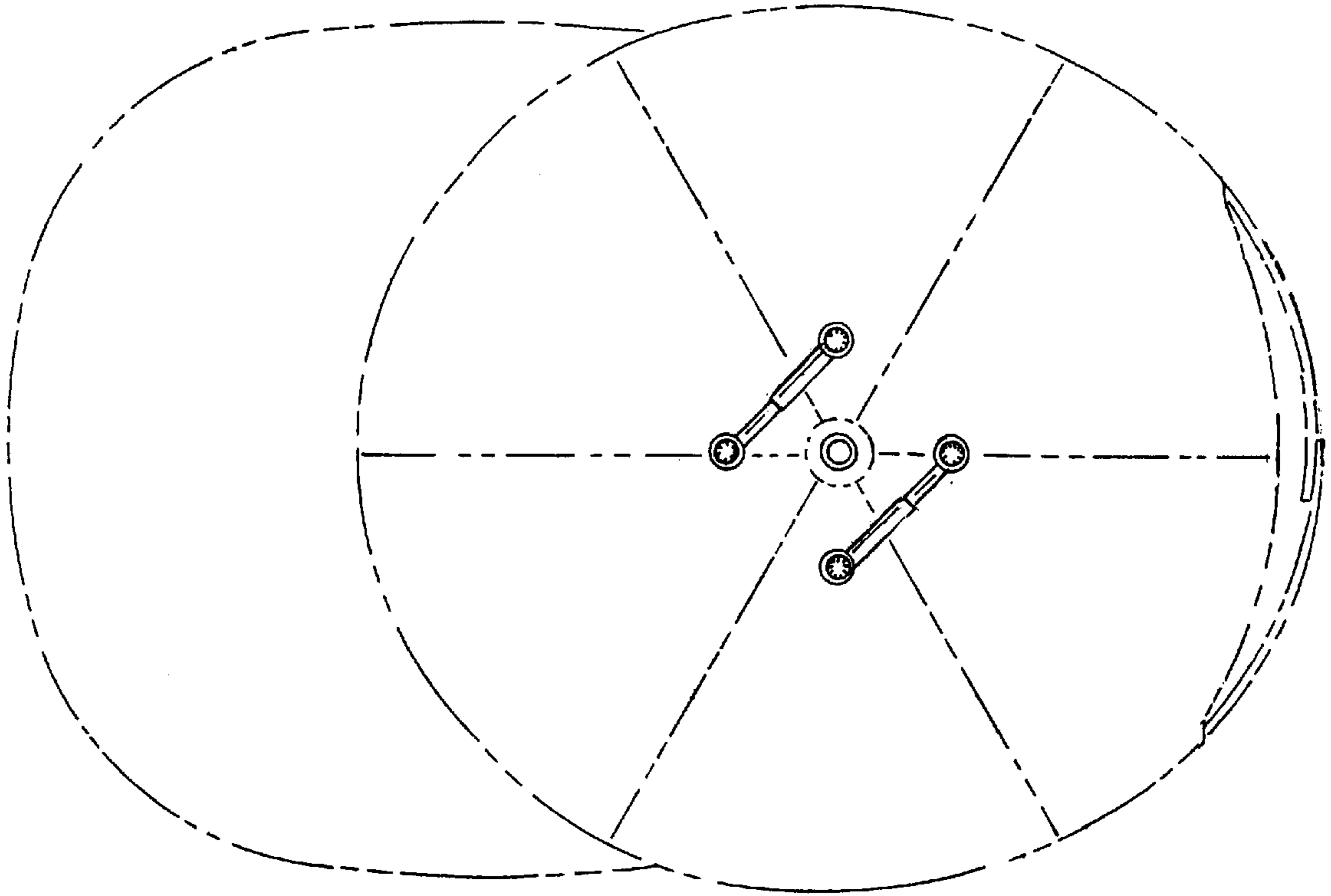

FIG. 7

