



US00D446882B1

(12) **United States Design Patent**  
**Angeletta**

(10) **Patent No.:** **US D446,882 S**

(45) **Date of Patent:** **\*\* Aug. 21, 2001**

(54) **PALM HELD LIQUID AND LOTION APPLICATOR**

(76) Inventor: **Joseph G. Angeletta**, 418 Fifth St.,  
Mamaroneck, NY (US) 10543

(\*\*) Term: **14 Years**

(21) Appl. No.: **29/136,061**

(22) Filed: **Jan. 24, 2001**

(51) **LOC (7) Cl.** ..... **28-02**

(52) **U.S. Cl.** ..... **D28/7**

(58) **Field of Search** ..... D28/7, 76; D9/338,  
D9/504, 506, 529, 523, 424, 561, 549;  
D19/70, 71; 206/208, 213, 218, 219, 220,  
385, 581, 823; 401/49, 60, 61, 89, 98, 202,  
205; 132/317, 318, 320

(56) **References Cited**

**U.S. PATENT DOCUMENTS**

- D. 57,707 \* 4/1921 Morrison ..... D9/529 X
- D. 115,068 \* 5/1939 Jenson ..... D9/561
- D. 242,526 \* 11/1976 Carré ..... D9/529
- D. 271,049 \* 10/1983 Duckett ..... D28/7
- D. 388,708 \* 1/1998 Monaghan ..... D9/523
- D. 423,713 \* 4/2000 Szekely ..... D28/7
- 2,100,855 \* 11/1937 Kelly ..... 401/205
- 4,728,210 \* 3/1988 Barish et al. .... 407/6

\* cited by examiner

*Primary Examiner*—Paula A. Mortimer  
(74) *Attorney, Agent, or Firm*—Scully, Scott, Murphy & Presser

(57) **CLAIM**

The ornamental design for a palm held liquid and lotion applicator, as shown and described.

**DESCRIPTION**

FIG. 1 illustrates a top perspective view of a first embodiment the palm held liquid and lotion applicator showing my new and ornamental design,  
 FIG. 2 illustrates side view, the opposite side being a mirror-image thereof;  
 FIG. 3 illustrates a bottom plan view thereof;  
 FIG. 4 illustrates a top plan thereof;  
 FIG. 5 is a perspective view of the cover for a palm held liquid and lotion applicator drawn separately for purposes of illustration;  
 FIG. 6 illustrates a top plan view thereof;  
 FIG. 7 illustrates a side view thereof;  
 FIG. 8 illustrates the cover as mounted on the applicator of FIG. 1;  
 FIG. 9 illustrates a top perspective view of a second embodiment showing my ornamental design;  
 FIG. 10 illustrates a side view, the opposites side being a mirror-image thereof;  
 FIG. 11 illustrates a bottom plan view thereof; and,  
 FIG. 12 illustrates a top plan view thereof.

**1 Claim, 3 Drawing Sheets**

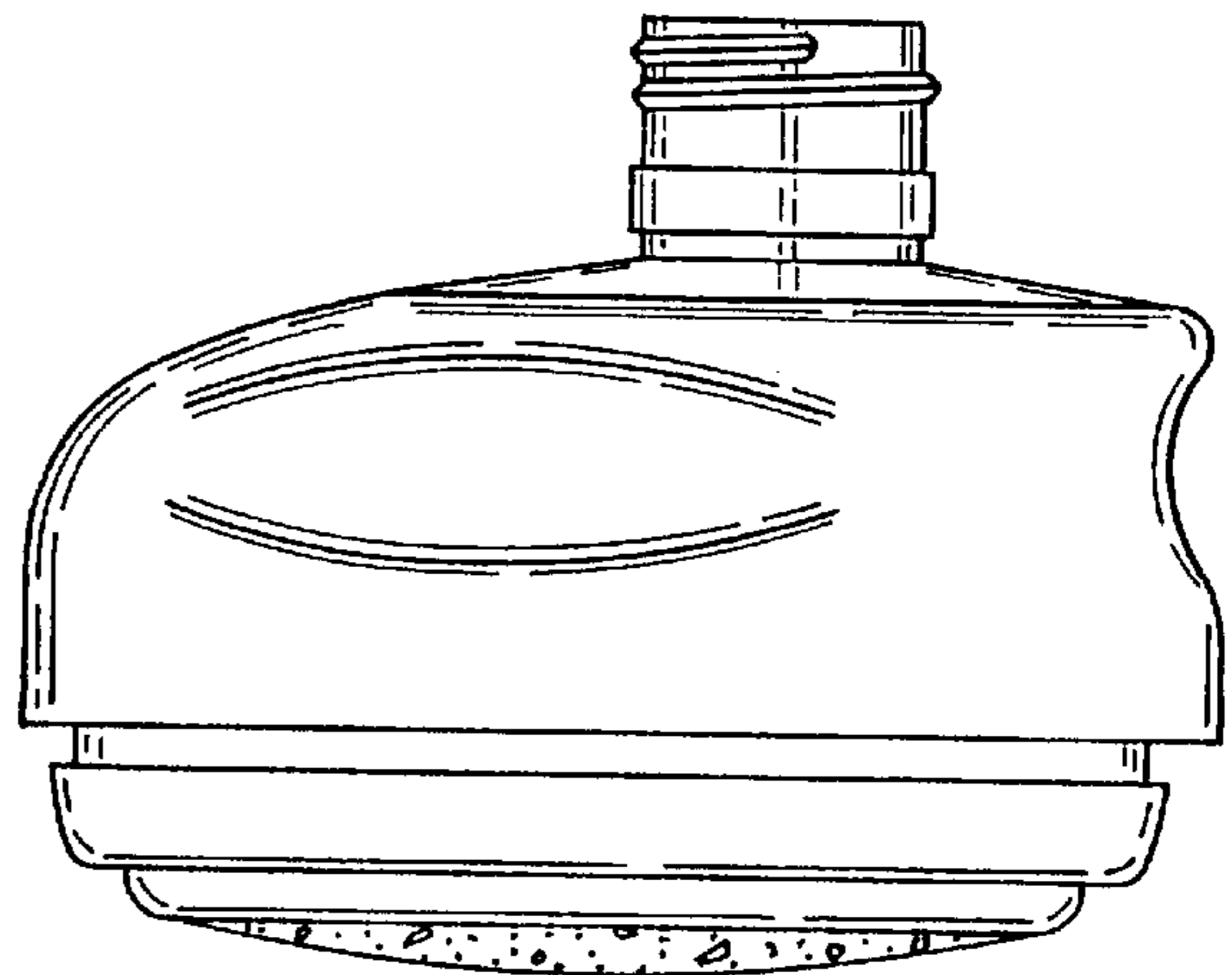
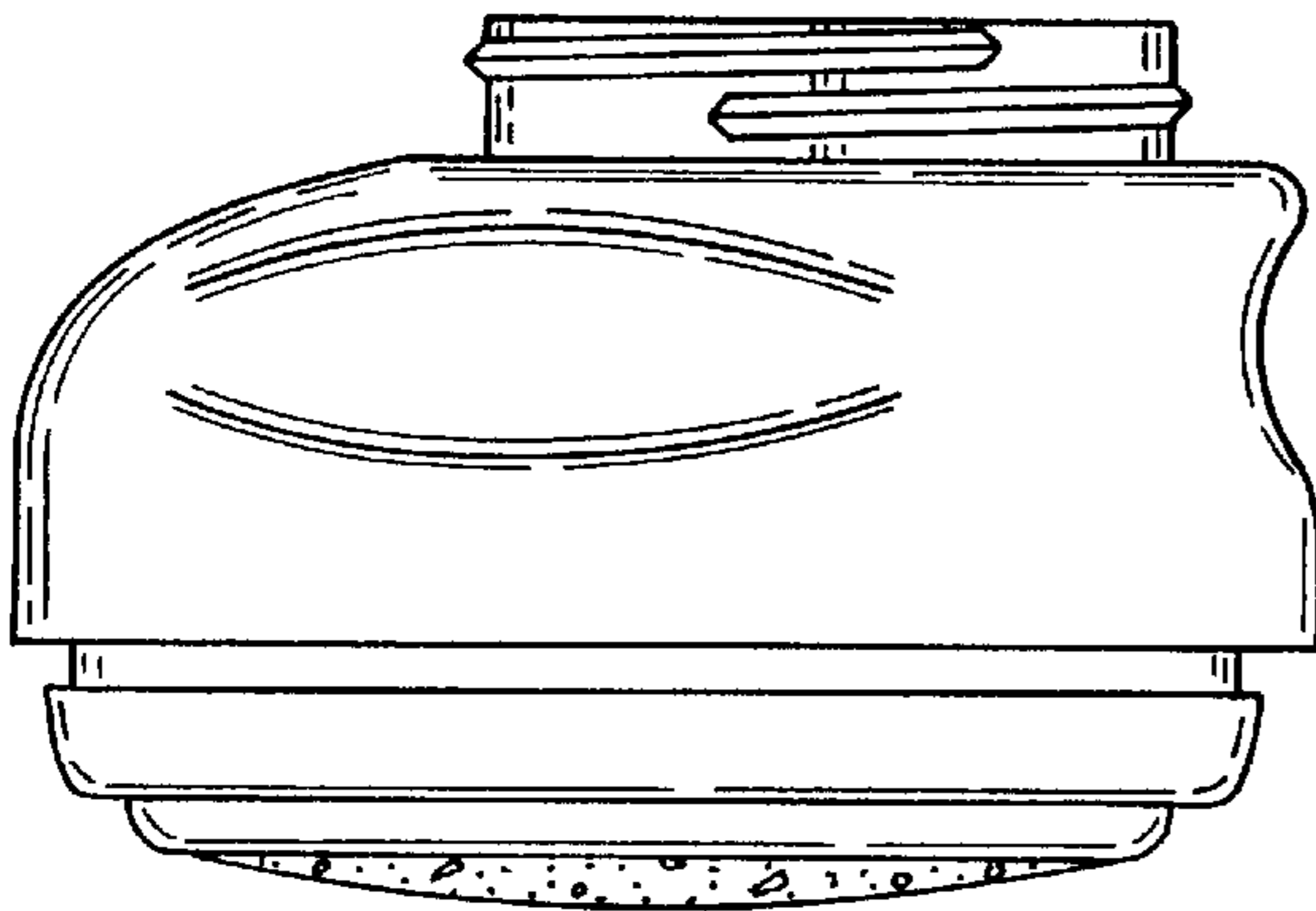

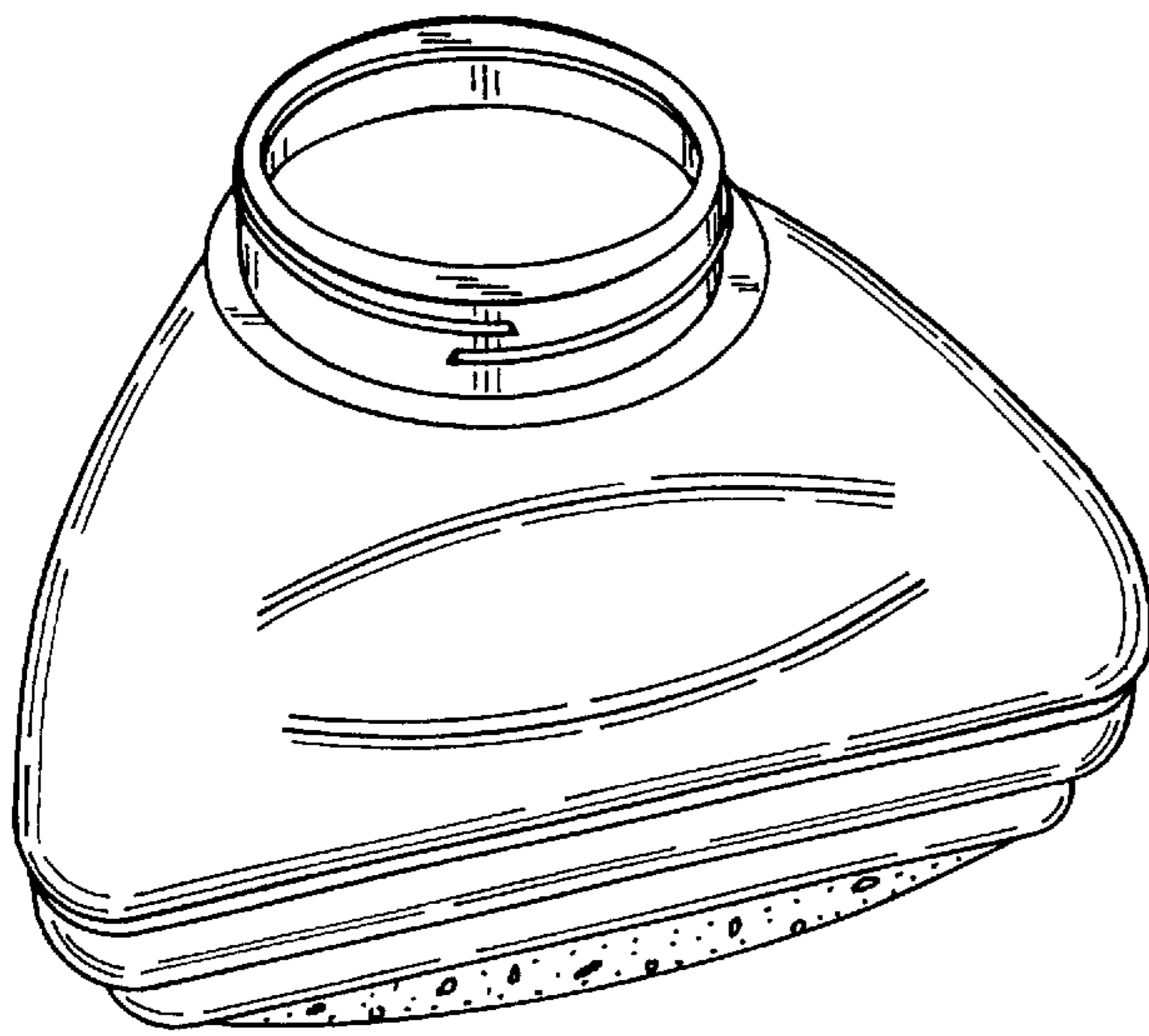

FIG. 1

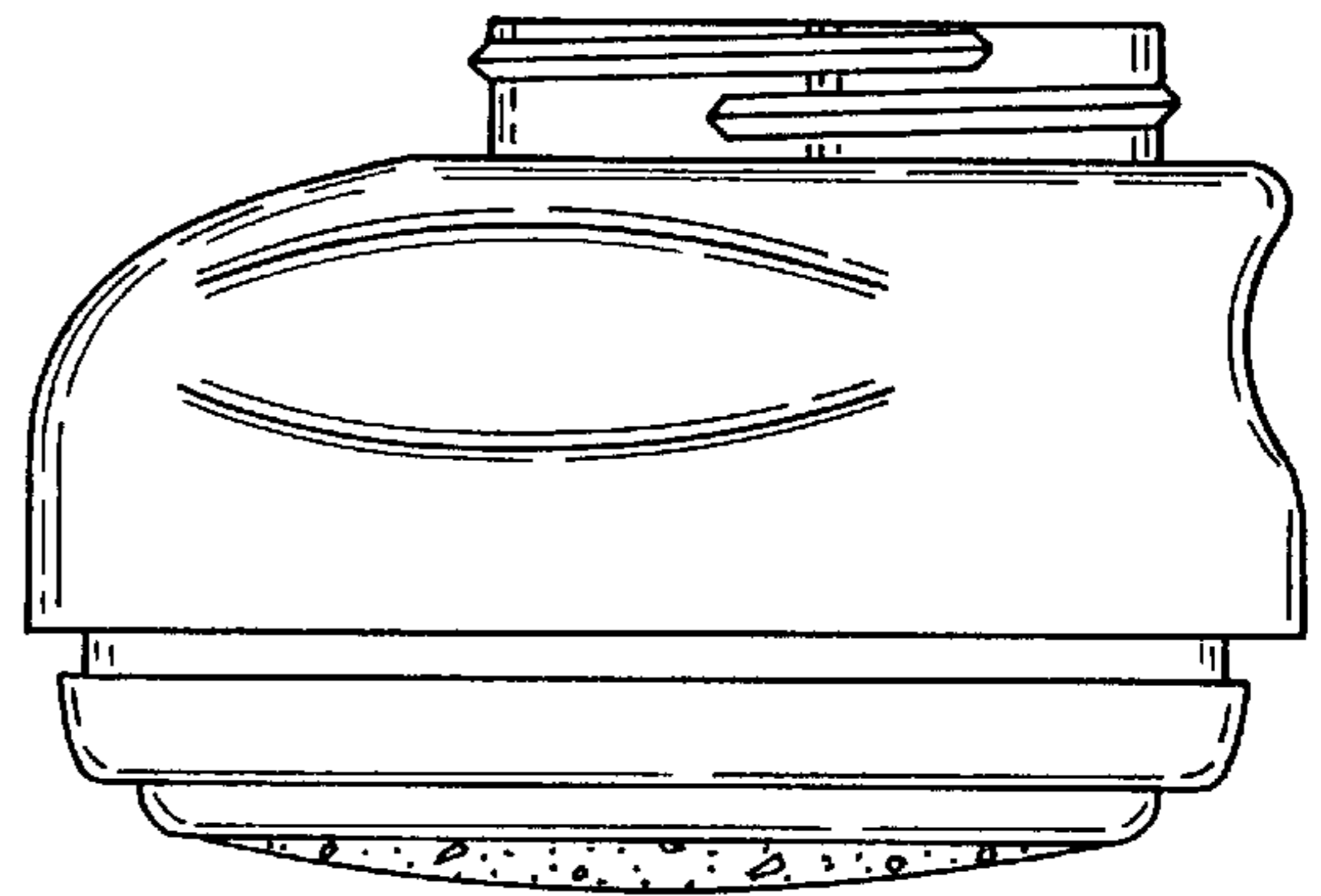

FIG. 2

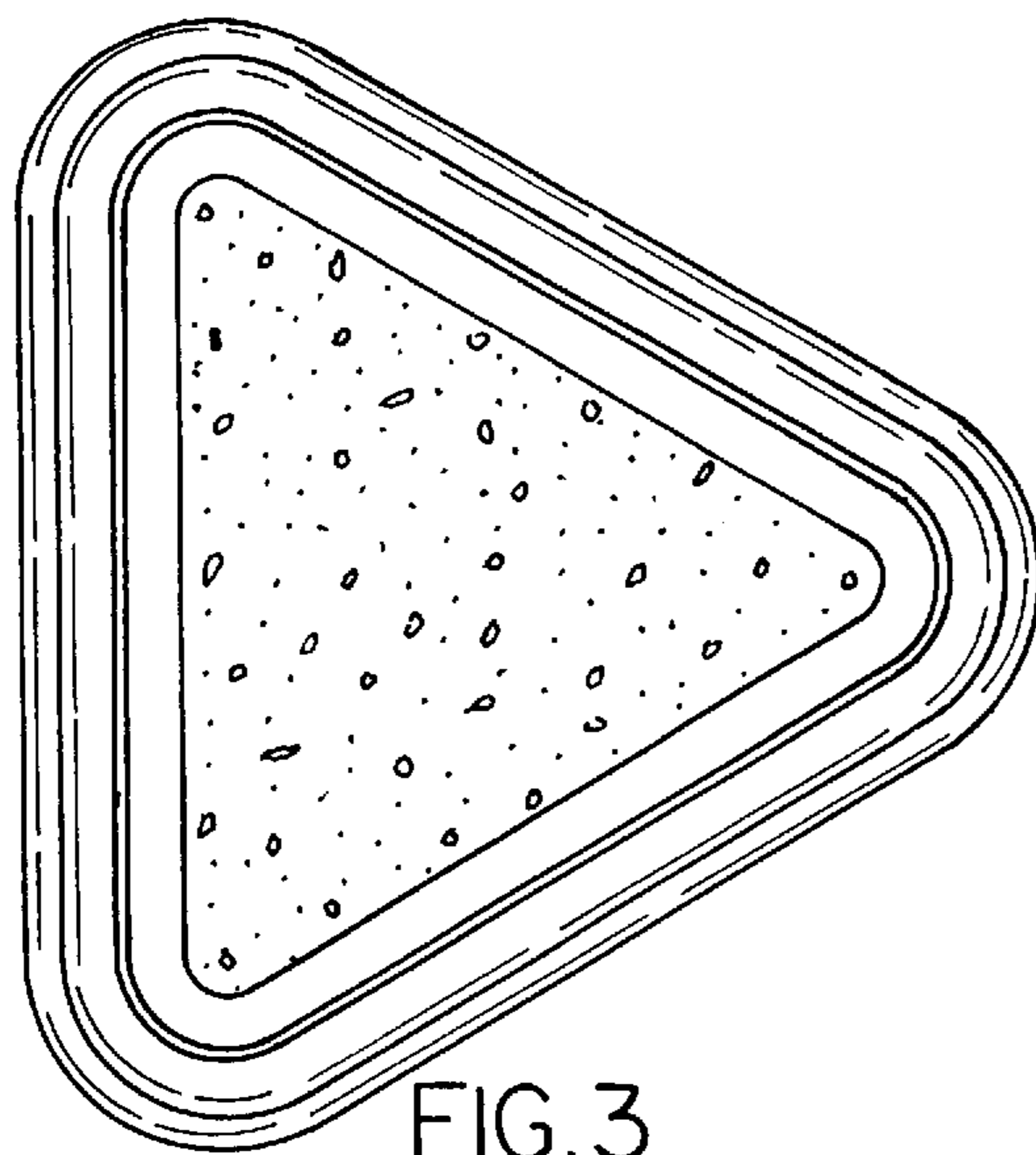

FIG. 3

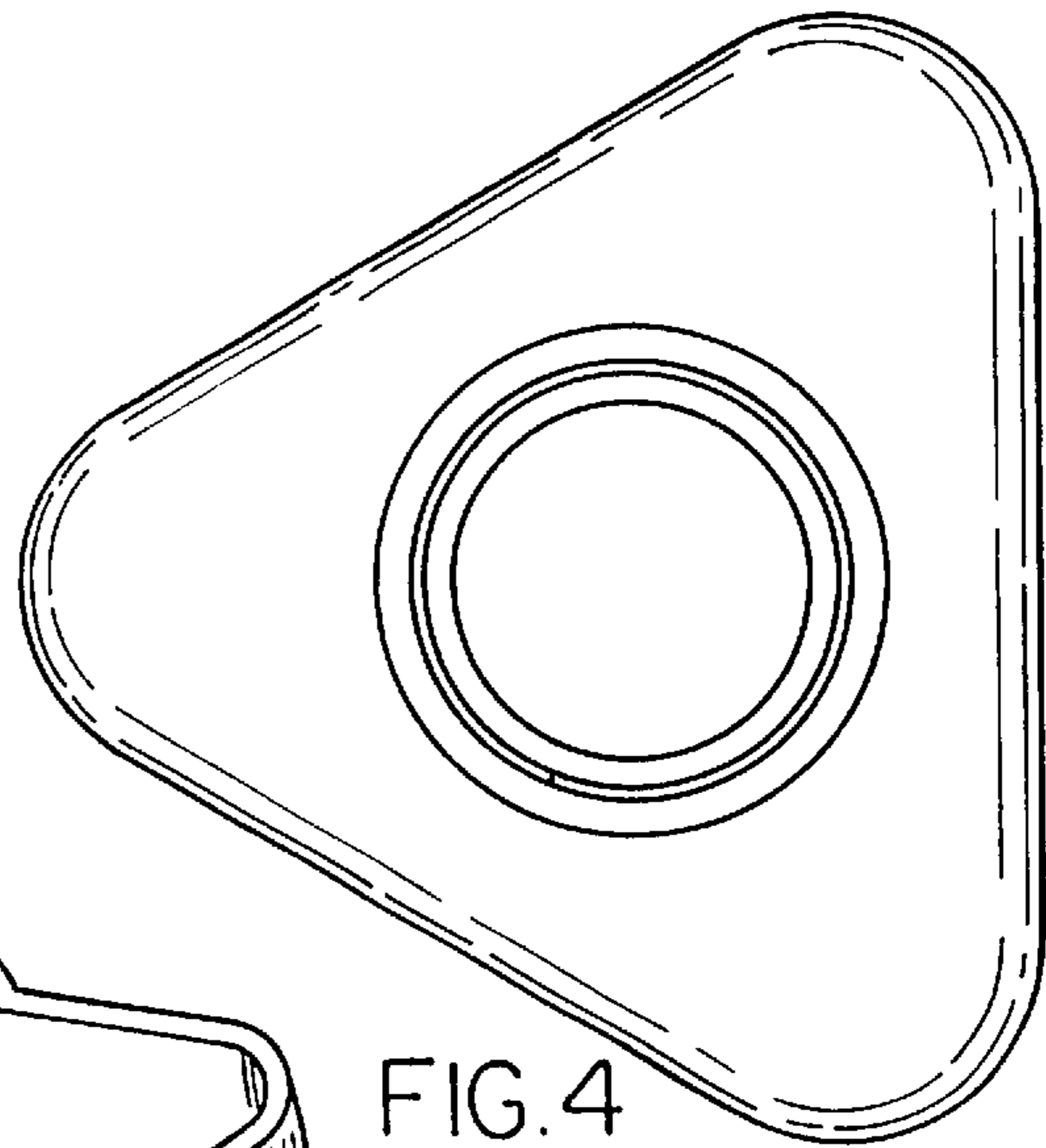

FIG. 4

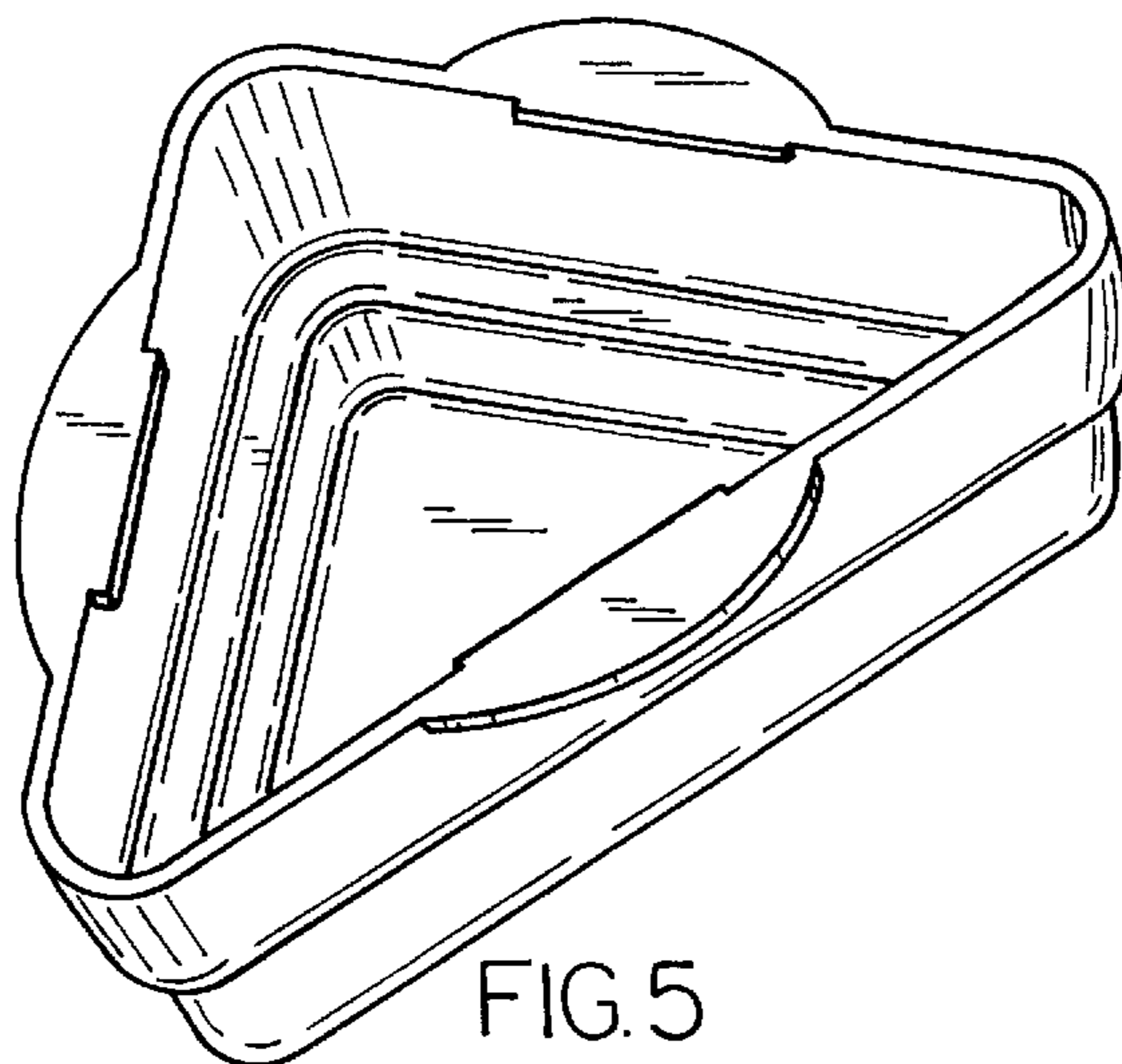

FIG. 5

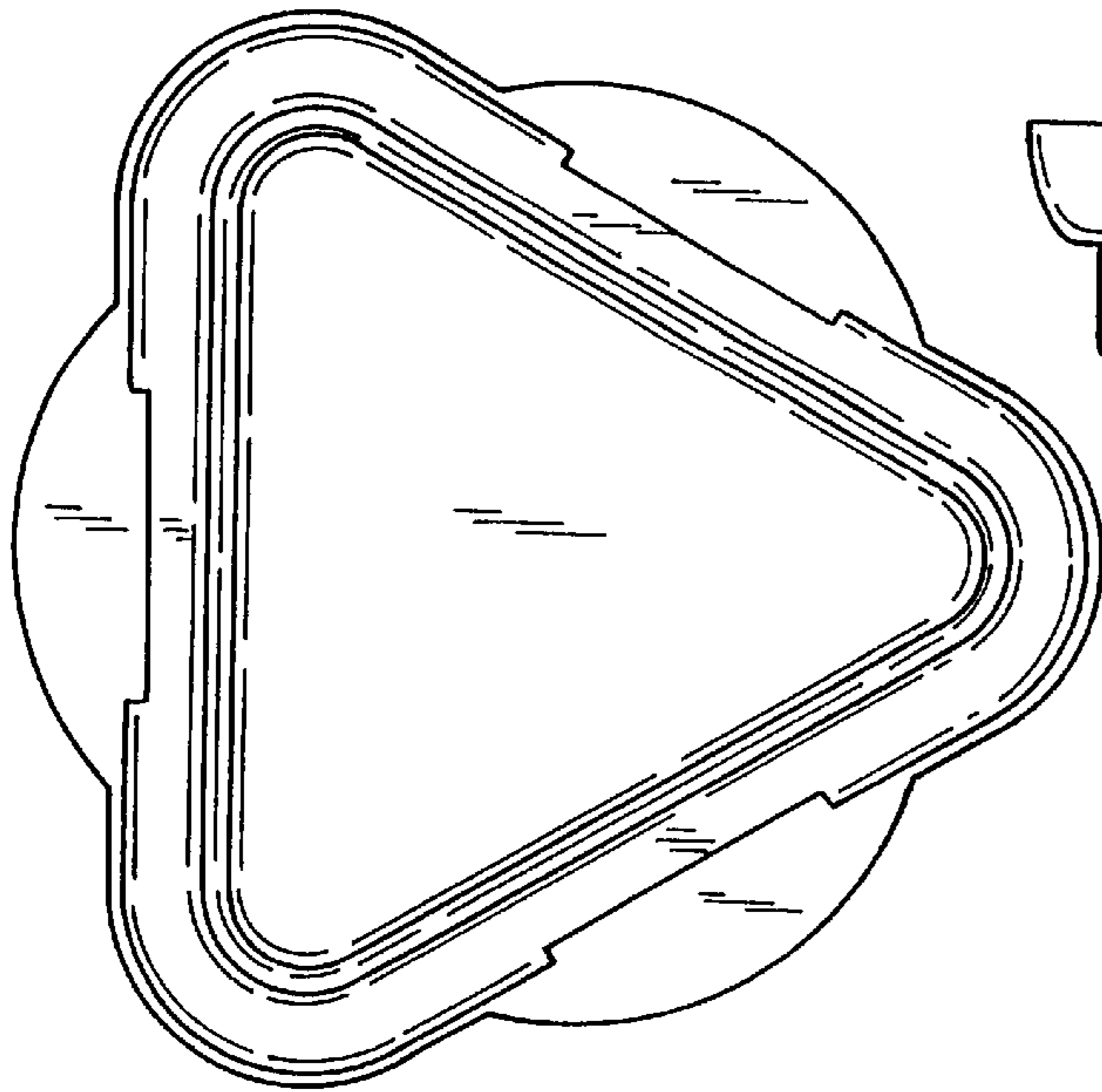

FIG. 6

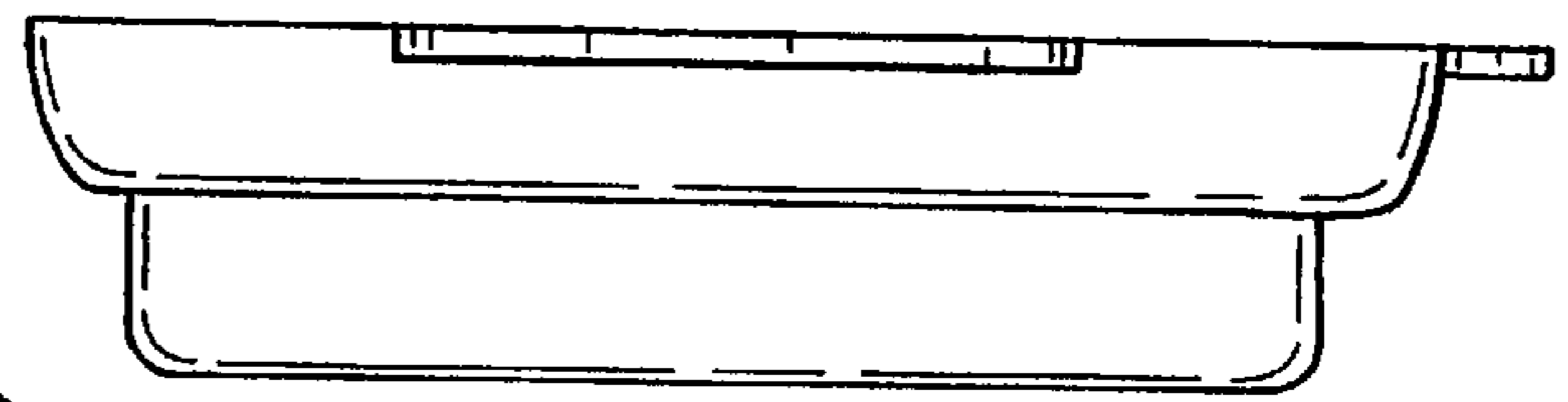

FIG. 7

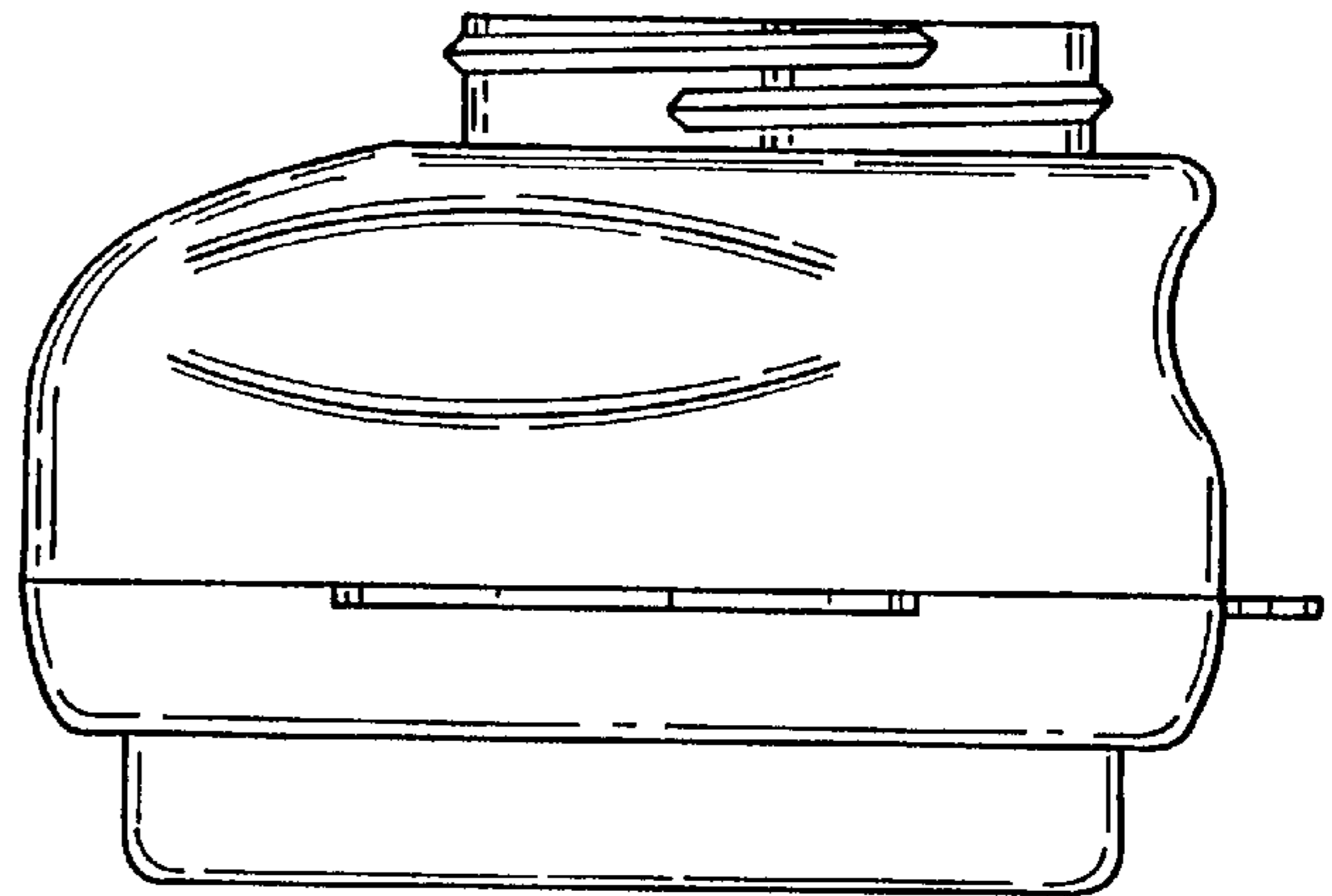

FIG. 8

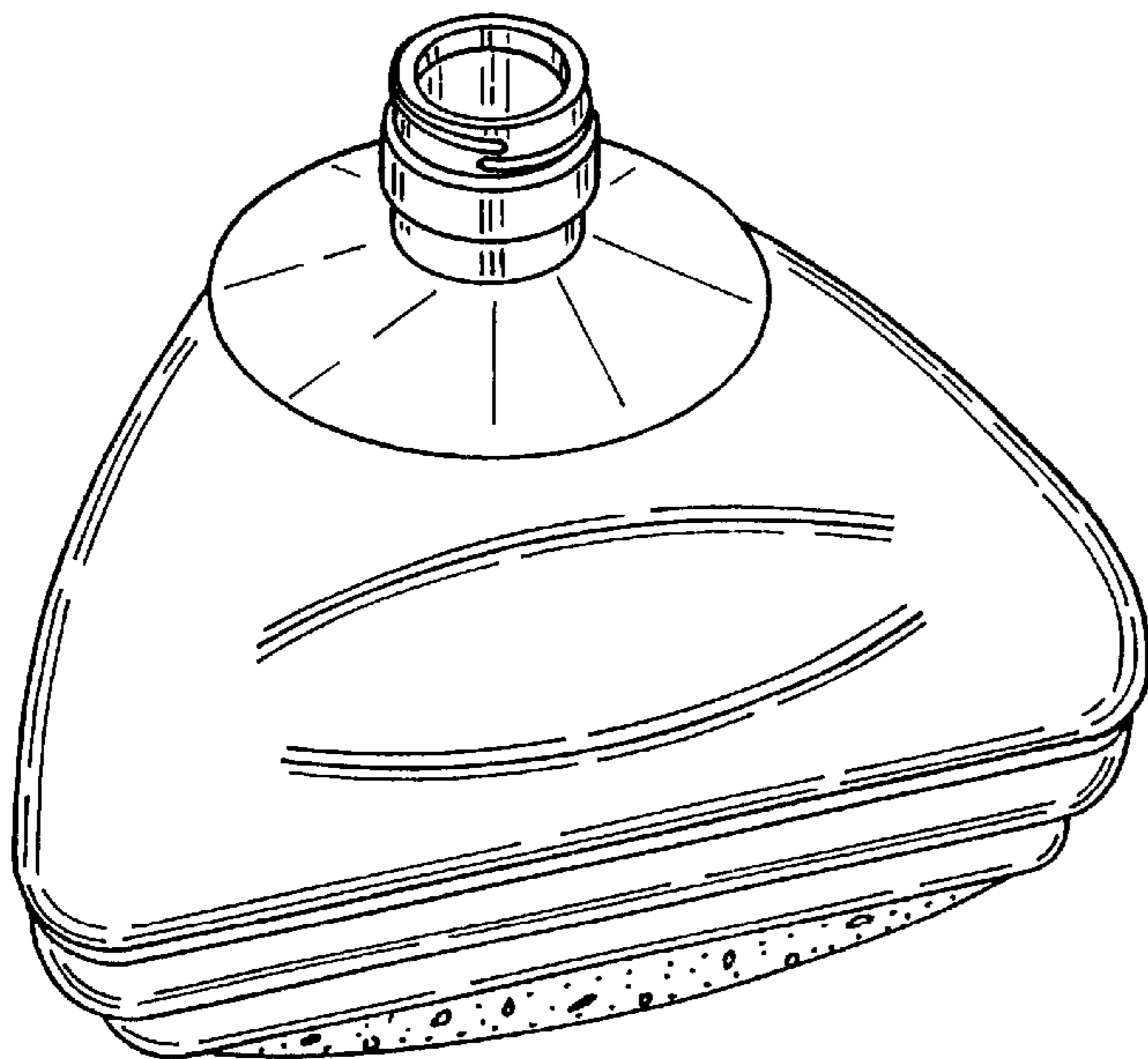

FIG. 9

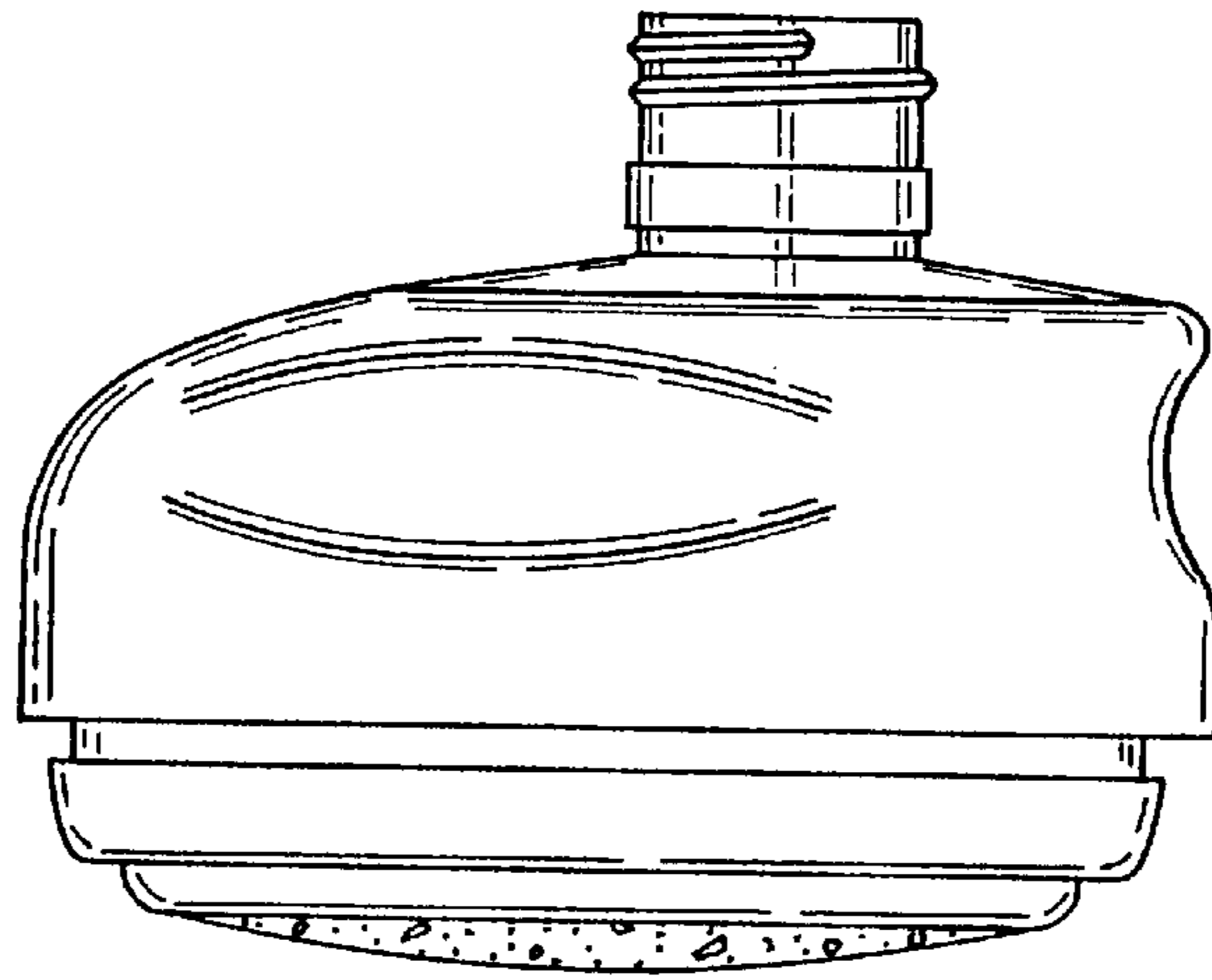

FIG. 10

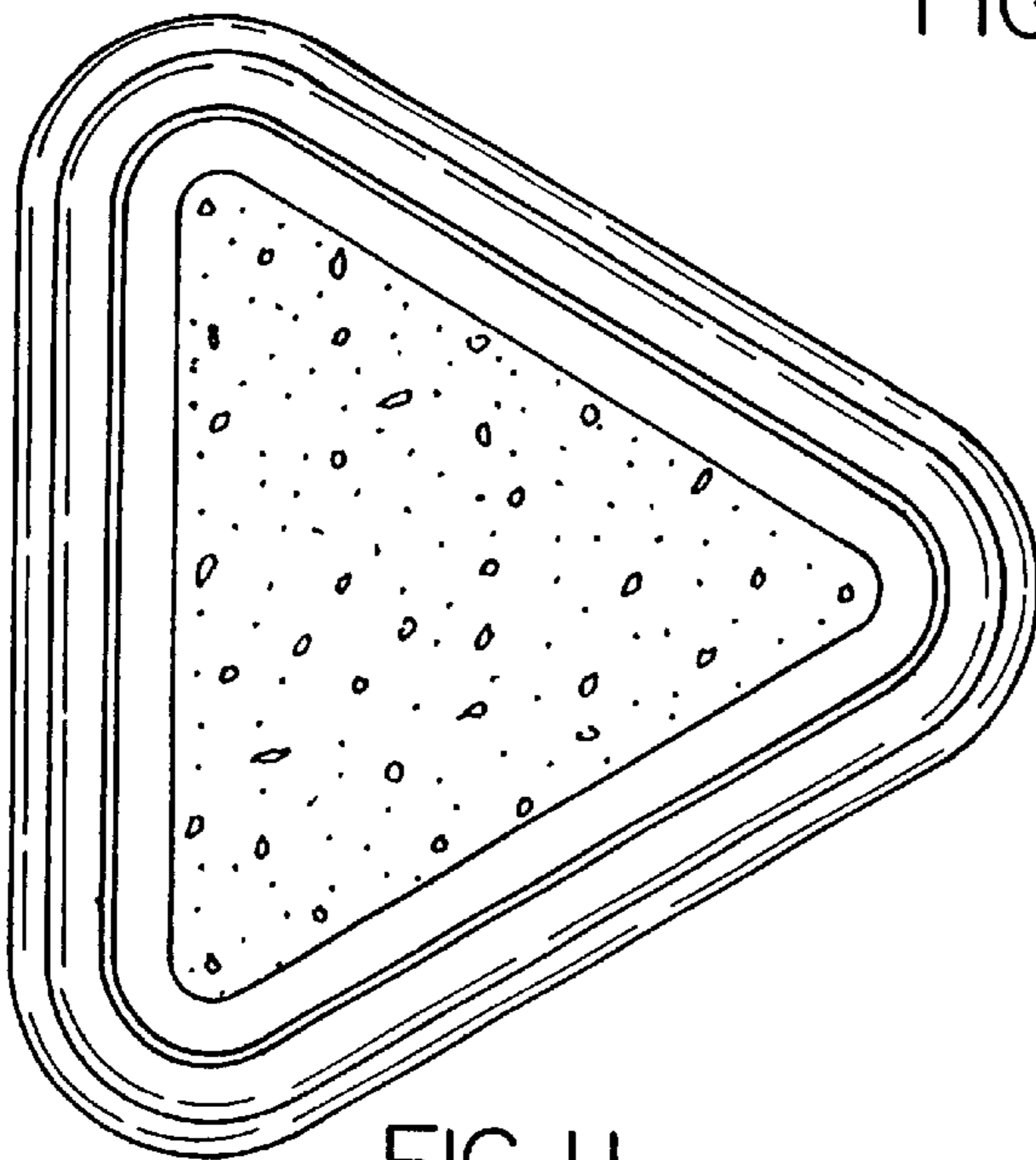

FIG. 11

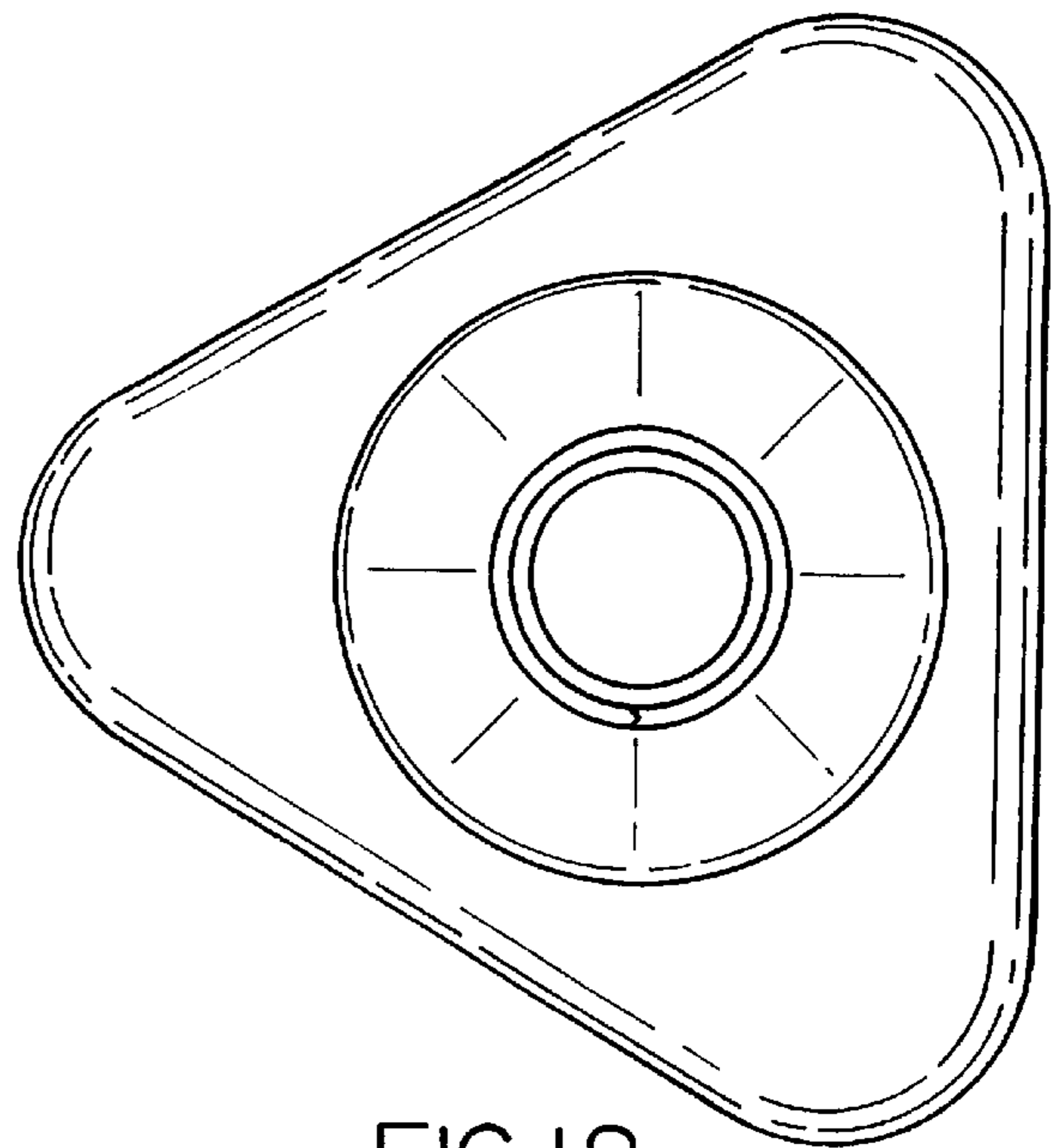

FIG. 12