



US00D446814B1

(12) **United States Design Patent**
Lau

(10) **Patent No.:** **US D446,814 S**

(45) **Date of Patent:** **** Aug. 21, 2001**

(54) **WRITING PEN**

(75) **Inventor:** **Chor Beng Lau, Kowloon (HK)**

(73) **Assignee:** **Joyas Manufacturing Ltd., Kowloon (HK)**

(**) **Term:** **14 Years**

(21) **Appl. No.:** **29/140,404**

(22) **Filed:** **Apr. 18, 2001**

(51) **LOC (7) Cl.** **19-06**

(52) **U.S. Cl.** **D19/45; D19/49; D19/56; D19/57**

(58) **Field of Search** **D19/35, 36, 41-51, D19/53-58, 81-85; 401/99, 100, 102, 103, 104, 109-117, 209, 202, 243-247, 262, 98**

(56) **References Cited**

U.S. PATENT DOCUMENTS

D. 129,159	8/1941	Dreyfuss .	
D. 179,053	* 10/1956	Baker	D19/51
D. 200,510	* 3/1965	Fehling et al.	D19/51
D. 200,512	* 3/1965	Fehling	D19/51
D. 205,022	6/1966	Boss .	
D. 294,263	* 2/1988	Rodgers et al.	D19/49 X
D. 319,633	9/1991	Katami .	
D. 331,750	12/1992	Yang .	
D. 332,964	2/1993	Giugiaro .	
D. 334,023	* 3/1993	Giugiaro	D19/49
D. 337,350	7/1993	Wong .	
D. 395,918	7/1998	Rosenbaum .	
D. 396,729	* 8/1998	Ham	D19/48
D. 398,641	* 9/1998	Hollington	D19/43
D. 398,934	* 9/1998	Veillon	D19/51
D. 407,436	3/1999	Chevalier et al. .	
D. 416,042	11/1999	Burkhardt et al. .	

D. 431,598	* 10/2000	Kim et al.	D19/36
2,693,171	11/1954	Lanoie .	
3,272,184	9/1966	Crowley .	
4,200,403	4/1980	Chu .	

FOREIGN PATENT DOCUMENTS

WO 94/24029 10/1994 (WO) .

* cited by examiner

Primary Examiner—Martie K. Holtje

(74) *Attorney, Agent, or Firm*—Barlow, Josephs & Holmes

(57) **CLAIM**

The ornamental design for a writing pen, as shown and described.

DESCRIPTION

FIG. 1 is a perspective view of a writing pen, with the writing tip retracted, showing my new design;
 FIG. 2 is a front view thereof;
 FIG. 3 is a left side view thereof;
 FIG. 4 is a rear view thereof;
 FIG. 5 is a bottom view plan view thereof;
 FIG. 6 is a right side view thereof;
 FIG. 7 is a top plan view thereof;
 FIG. 8 is a perspective view of my design of FIG. 1 with the barrel in an alternate position and the writing tip extended;
 FIG. 9 is a front view of FIG. 8;
 FIG. 10 is a left side view of FIG. 8;
 FIG. 11 is a rear view of FIG. 8;
 FIG. 12 is a bottom plan view of FIG. 8;
 FIG. 13 is a right side view of FIG. 8; and,
 FIG. 14 is a top plan view of FIG. 8.

The writing tip depicted in FIGS. 8 through 14 has been shown for illustrative purposes only and forms no part of the claimed design.

1 Claim, 6 Drawing Sheets

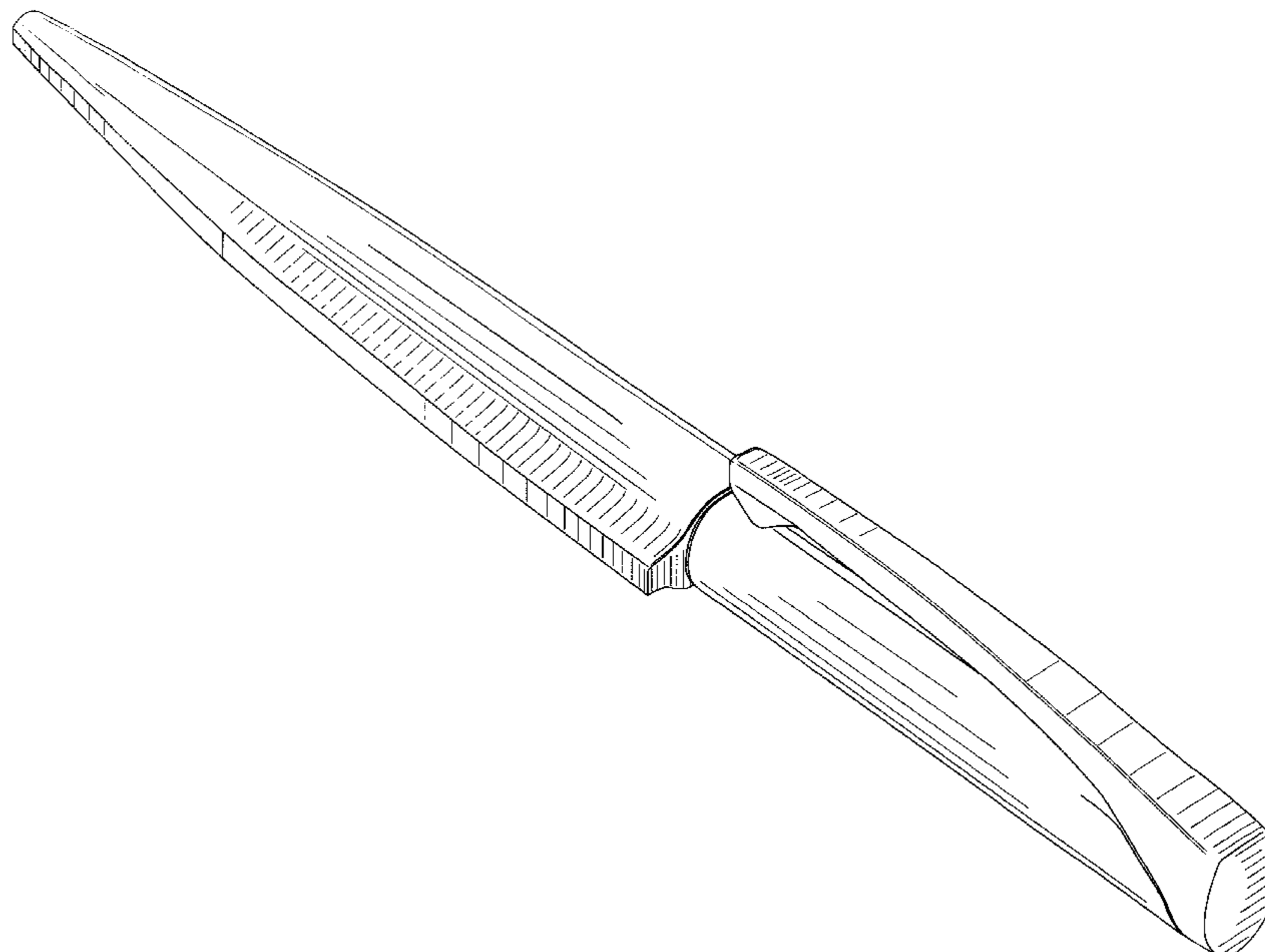

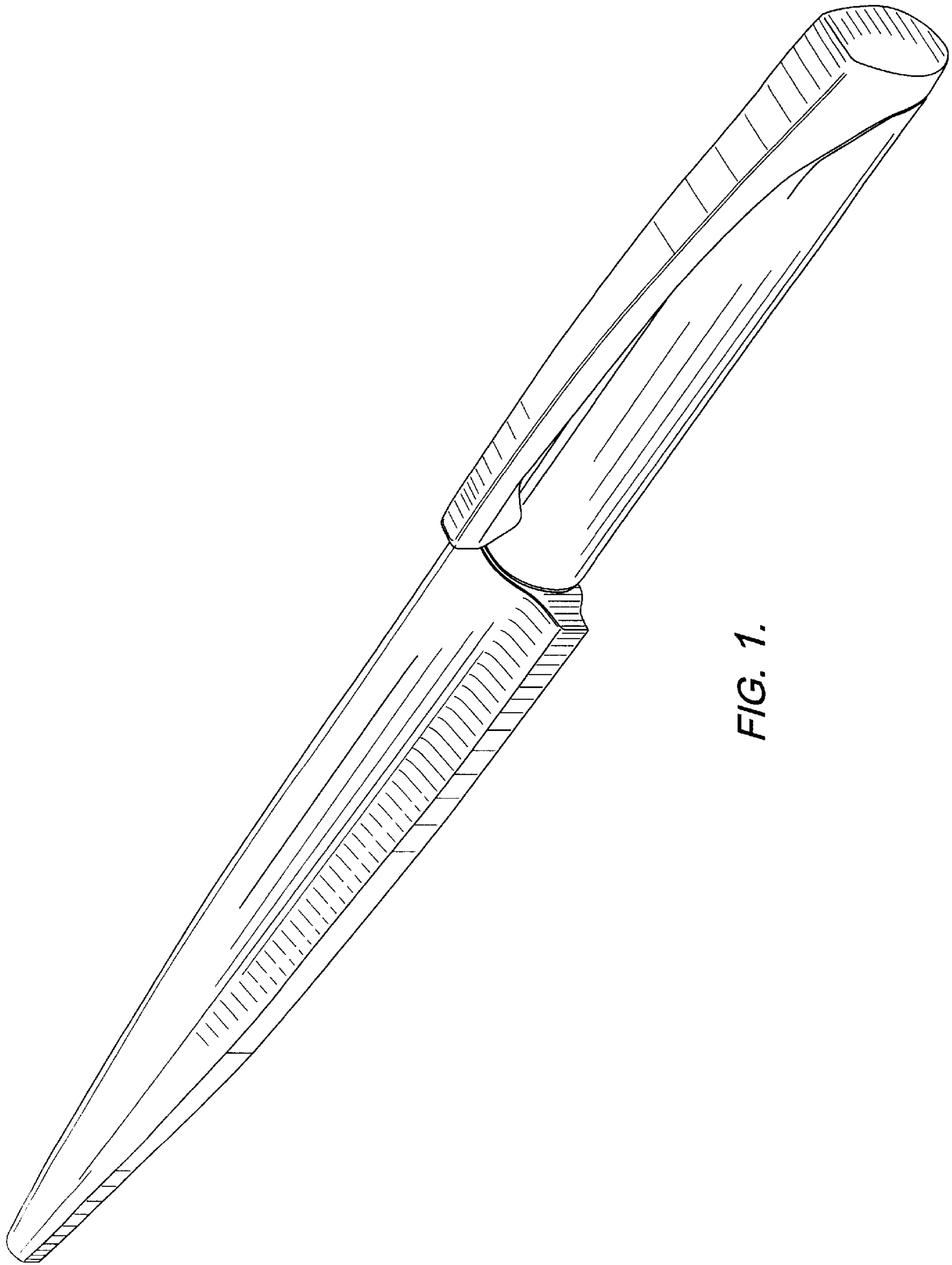

FIG. 1.

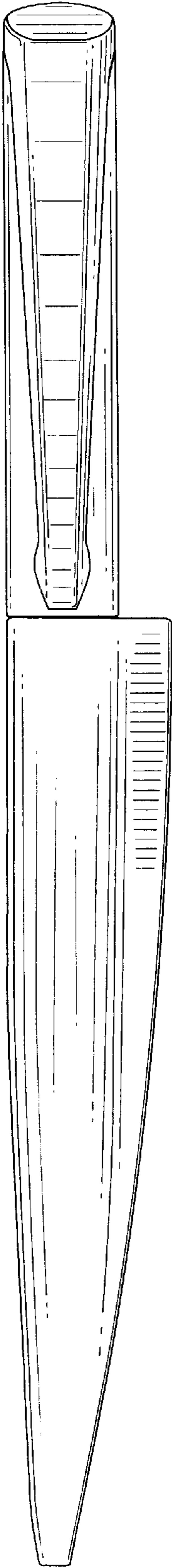

FIG. 2.



FIG. 3.

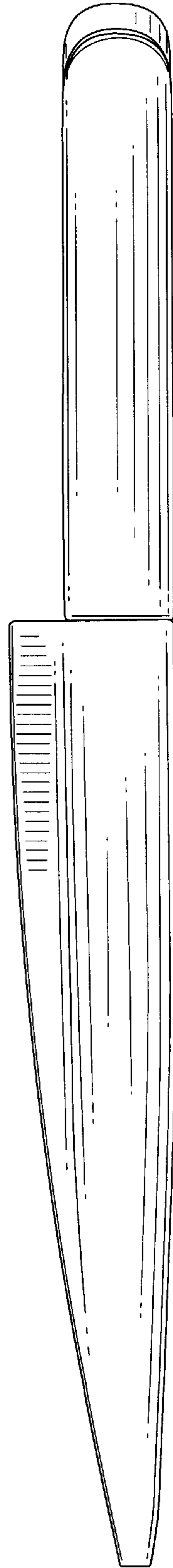

FIG. 4.

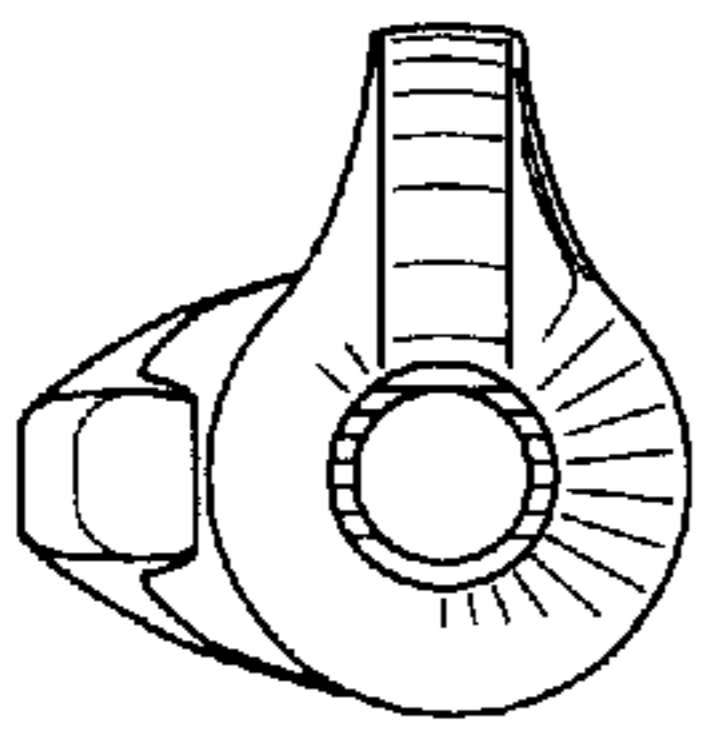

FIG. 5.

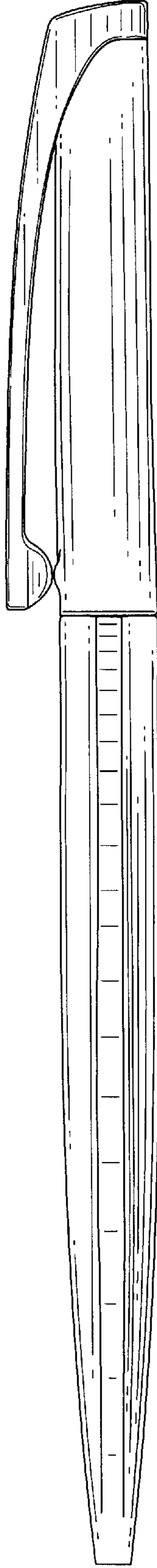

FIG. 6.

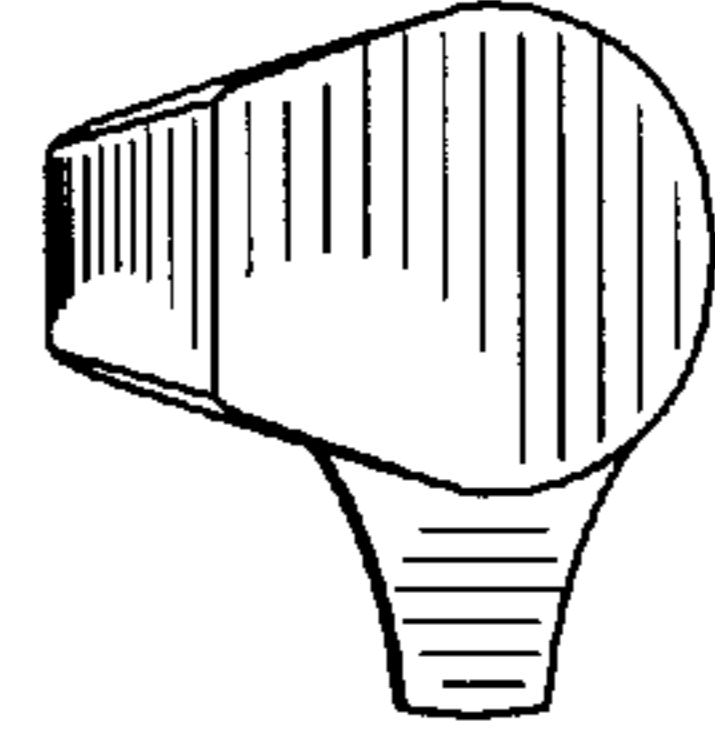

FIG. 7.

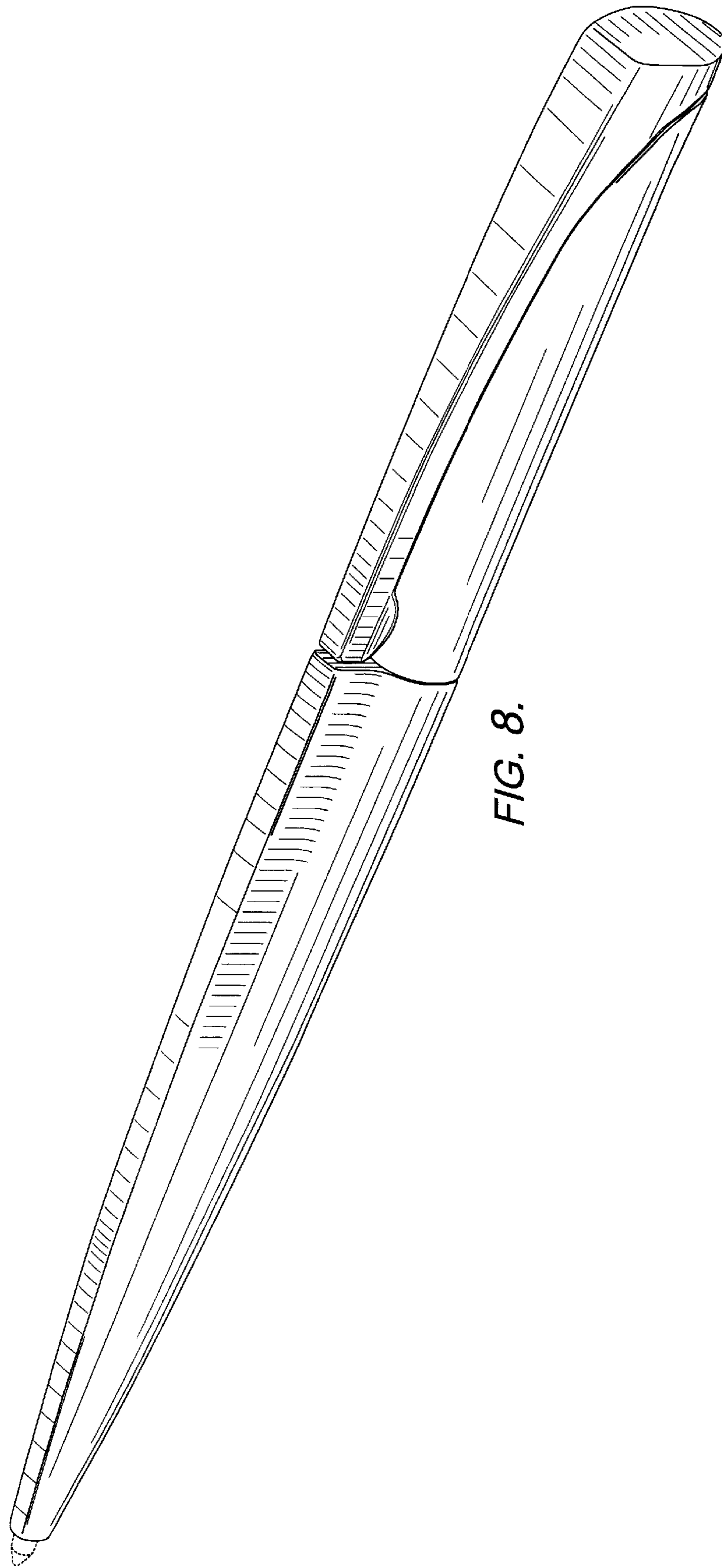

FIG. 8.

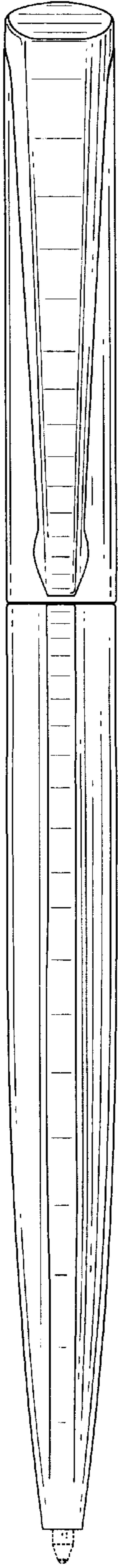

FIG. 9.



FIG. 10.

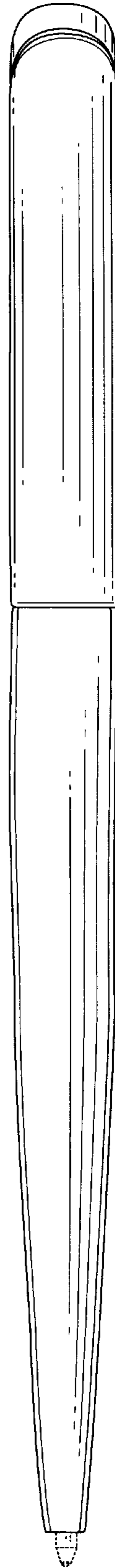

FIG. 11.

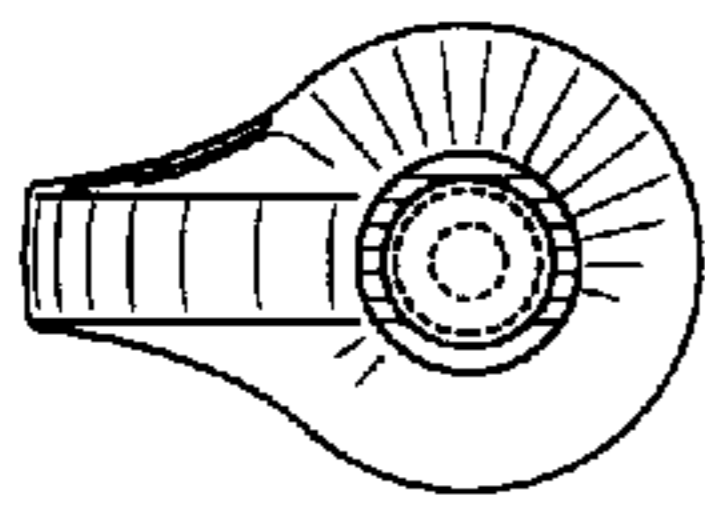

FIG. 12.

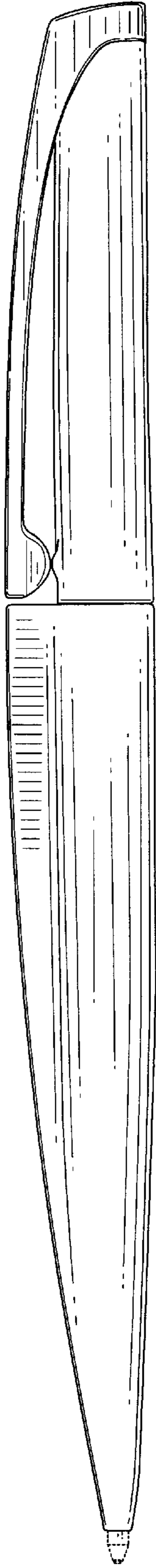

FIG. 13.

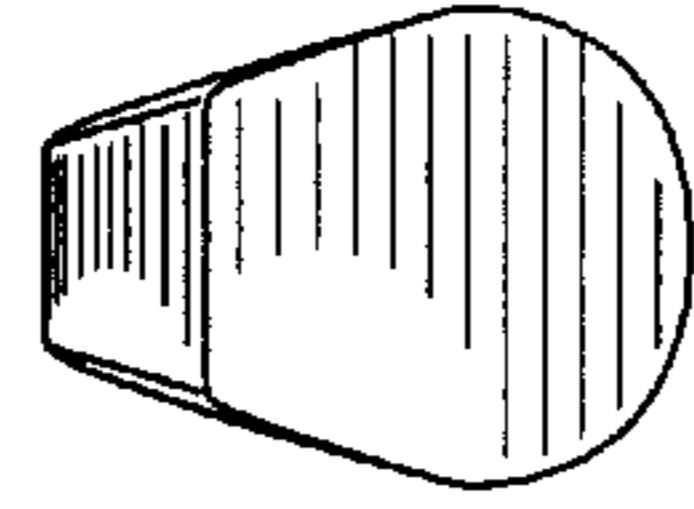

FIG. 14.