



US00D446781B1

(12) **United States Design Patent**  
**Hori et al.**

(10) **Patent No.:** **US D446,781 S**

(45) **Date of Patent:** **\*\* Aug. 21, 2001**

(54) **COMBINED DIGITAL AUDIO DISC PLAYER AND RADIO TUNER FOR VEHICLE**

(75) Inventors: **Tomoo Hori; Toshiyuki Itabashi**, both of Kanagawa (JP)

(73) Assignee: **Matsushita Electric Industrial Co., Ltd.**, Osaka (JP)

(\*\*) Term: **14 Years**

(21) Appl. No.: **29/134,975**

(22) Filed: **Jan. 2, 2001**

(30) **Foreign Application Priority Data**

Aug. 21, 2000 (JP) ..... 12-022885

(51) **LOC (7) Cl.** ..... **14-03**

(52) **U.S. Cl.** ..... **D14/157**

(58) **Field of Search** ..... D14/135, 136, D14/156, 157, 162, 164, 168, 188, 197, 198, 257, 258; 369/75.1, 75.2, 77.1, 77.2; 455/344, 347, 350, 355

(56) **References Cited**

**U.S. PATENT DOCUMENTS**

- D. 391,958 \* 3/1998 Miyazawa et al. .... D14/157
- D. 400,529 \* 11/1998 Kakizaki ..... D14/157
- D. 407,394 \* 3/1999 Oh ..... D14/135
- D. 428,865 \* 8/2000 Mishiwaki et al. .... D14/135

- D. 430,123 \* 8/2000 Shimohara et al. .... D14/135
- 5,848,042 \* 12/1998 Takahashi et al. .... 369/75.1
- 5,852,594 \* 12/1998 Kaise et al. .... 369/75.1
- 5,953,302 \* 9/1999 Kobayashi ..... 369/75.1

**FOREIGN PATENT DOCUMENTS**

1052279 10/1999 (JP) .

\* cited by examiner

*Primary Examiner*—Nanda Bondade

(74) *Attorney, Agent, or Firm*—Christensen O'Connor Johnson Kindness PLLC

(57) **CLAIM**

The ornamental design for a combined digital audio disc player and radio tuner for vehicle, as shown and described.

**DESCRIPTION**

FIG. 1 is a perspective view of the top, front and right side of a combined digital audio disc player and radio tuner for vehicle showing our new design; FIG. 2 is a top plan view thereof; FIG. 3 is a front view thereof; FIG. 4 is a right side view thereof; FIG. 5 is a left side view thereof; FIG. 6 is a rear view thereof; FIG. 7 is a bottom view thereof; and, FIG. 8 is a perspective view similar with FIG. 1 with the lid in open condition.

**1 Claim, 5 Drawing Sheets**

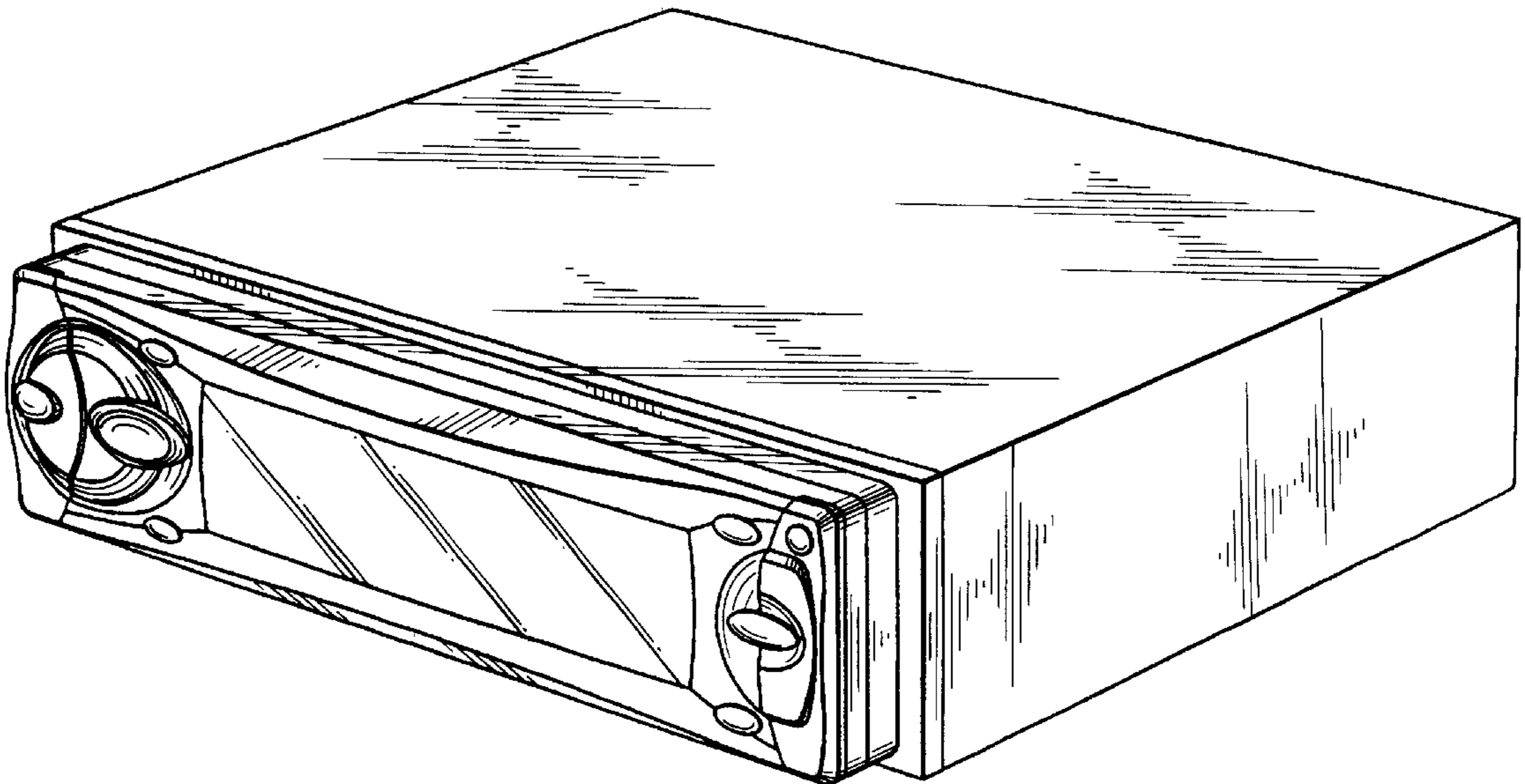
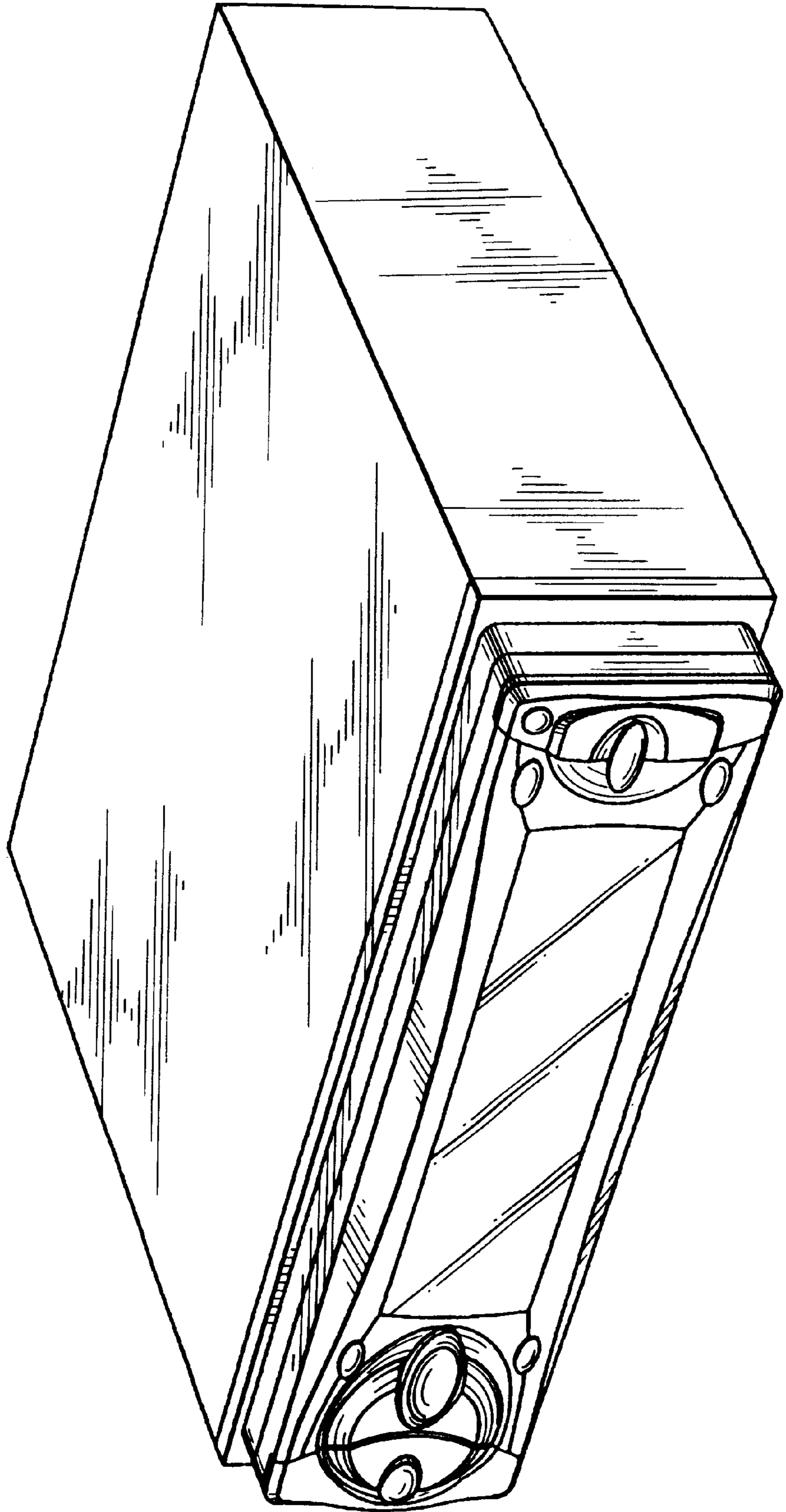
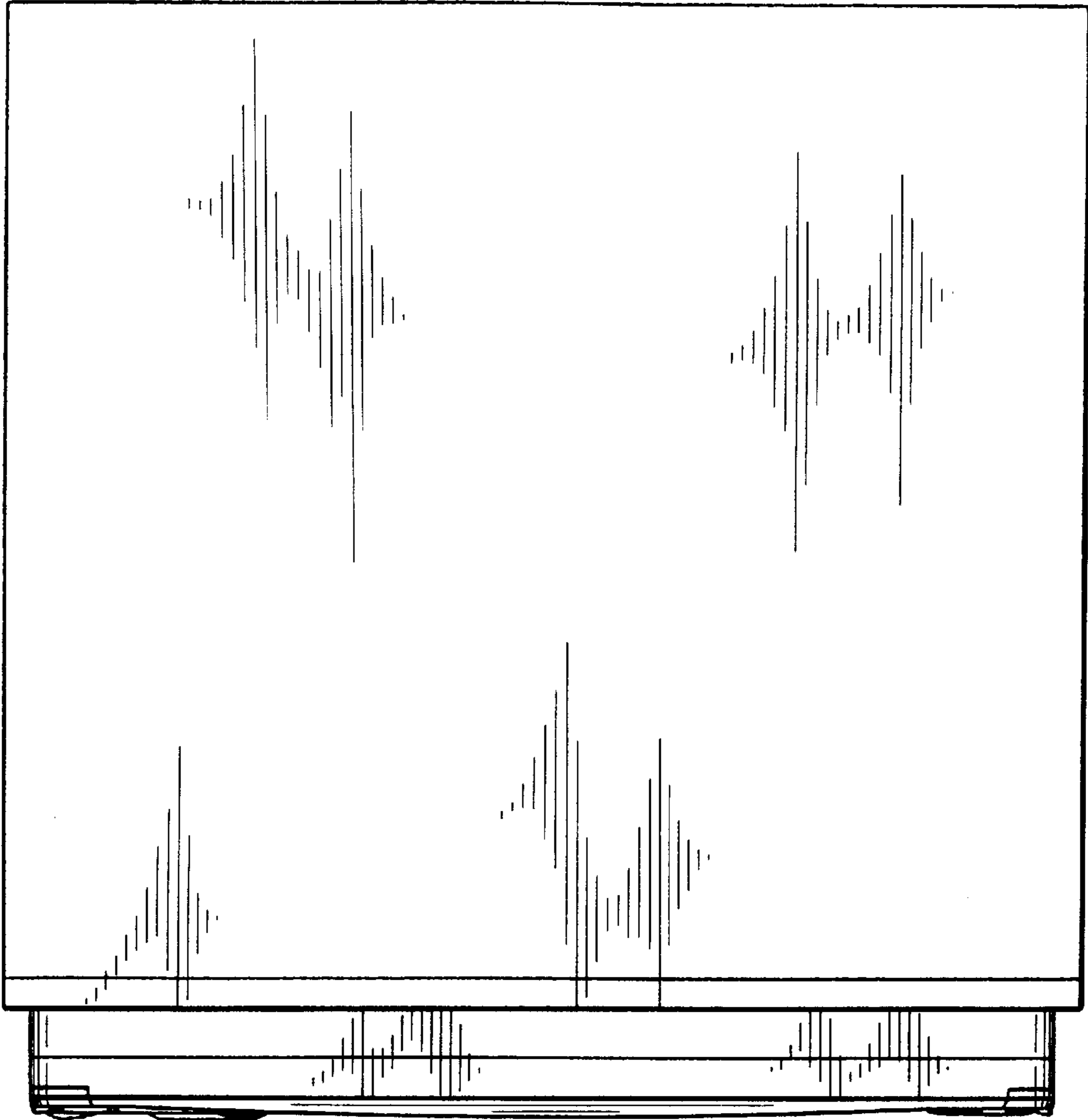

FIG. 1



*FIG. 2*



*FIG. 3*

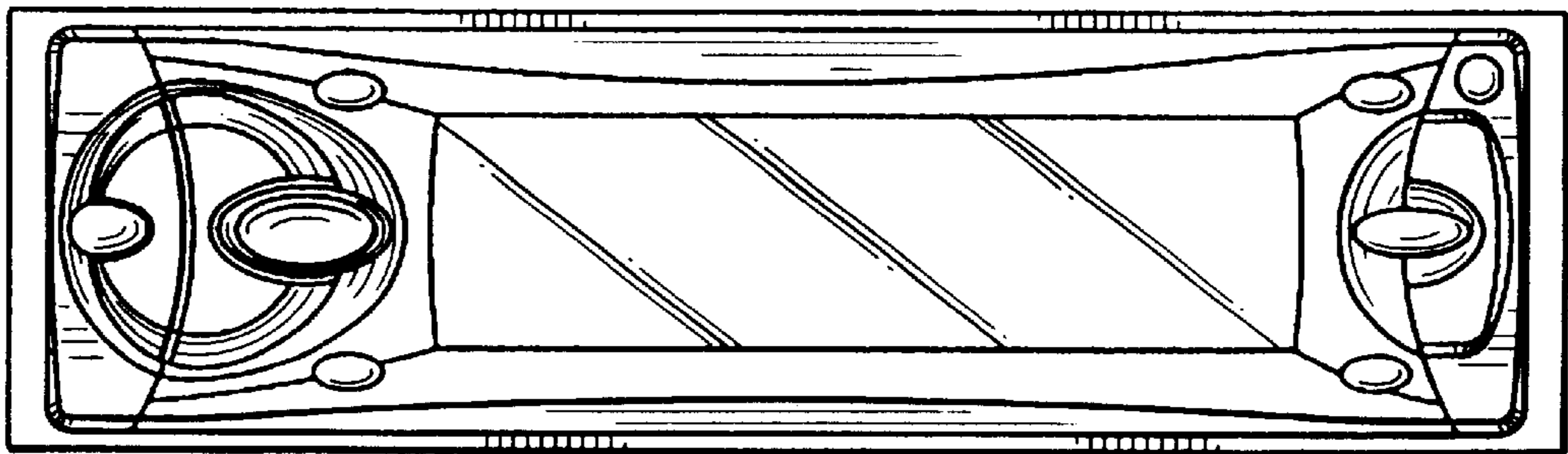

*FIG. 4*

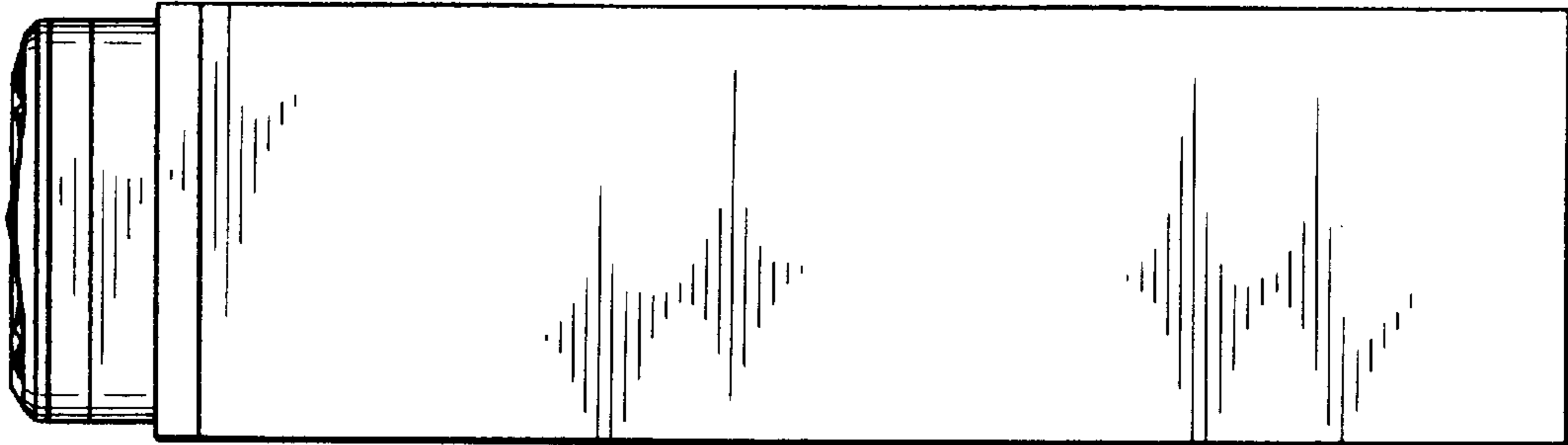

*FIG. 5*

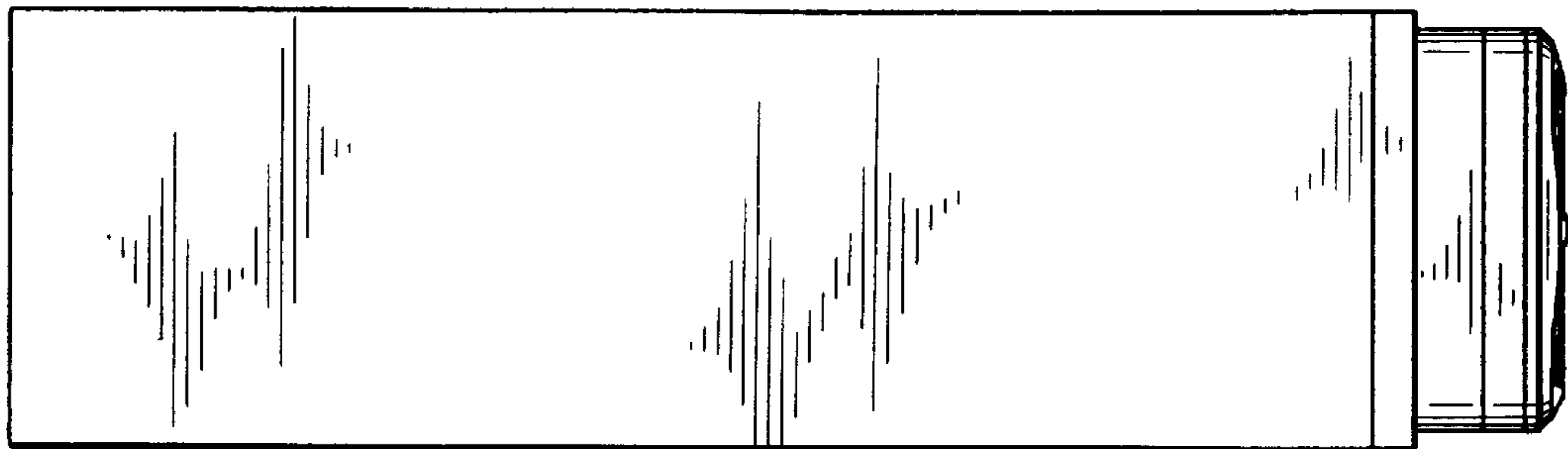

*FIG. 6*

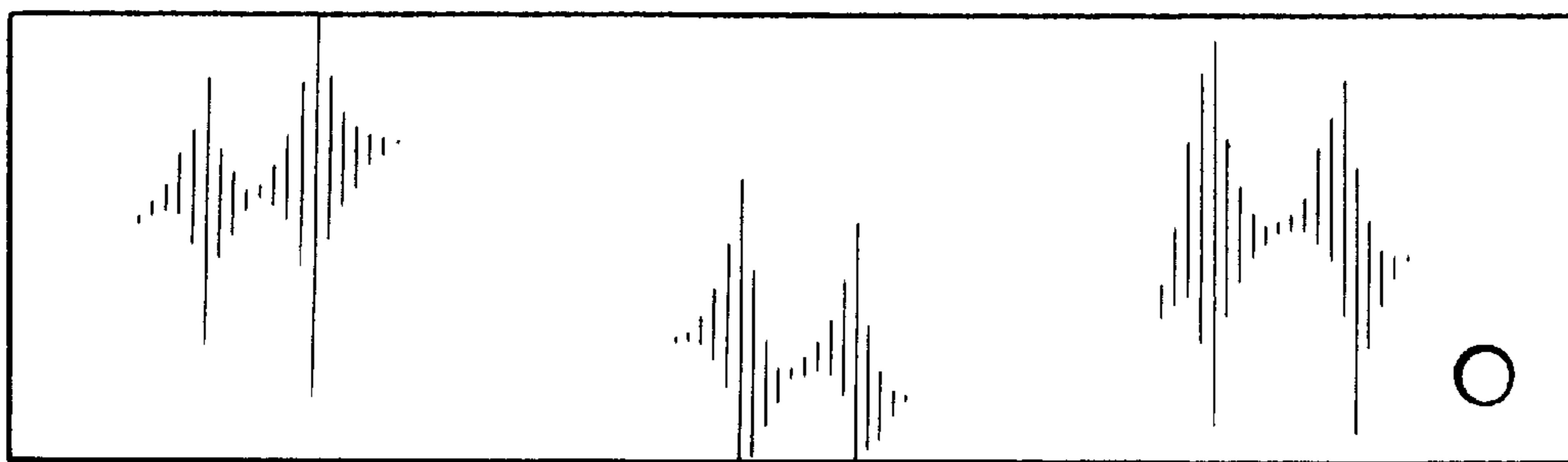

*FIG. 7*

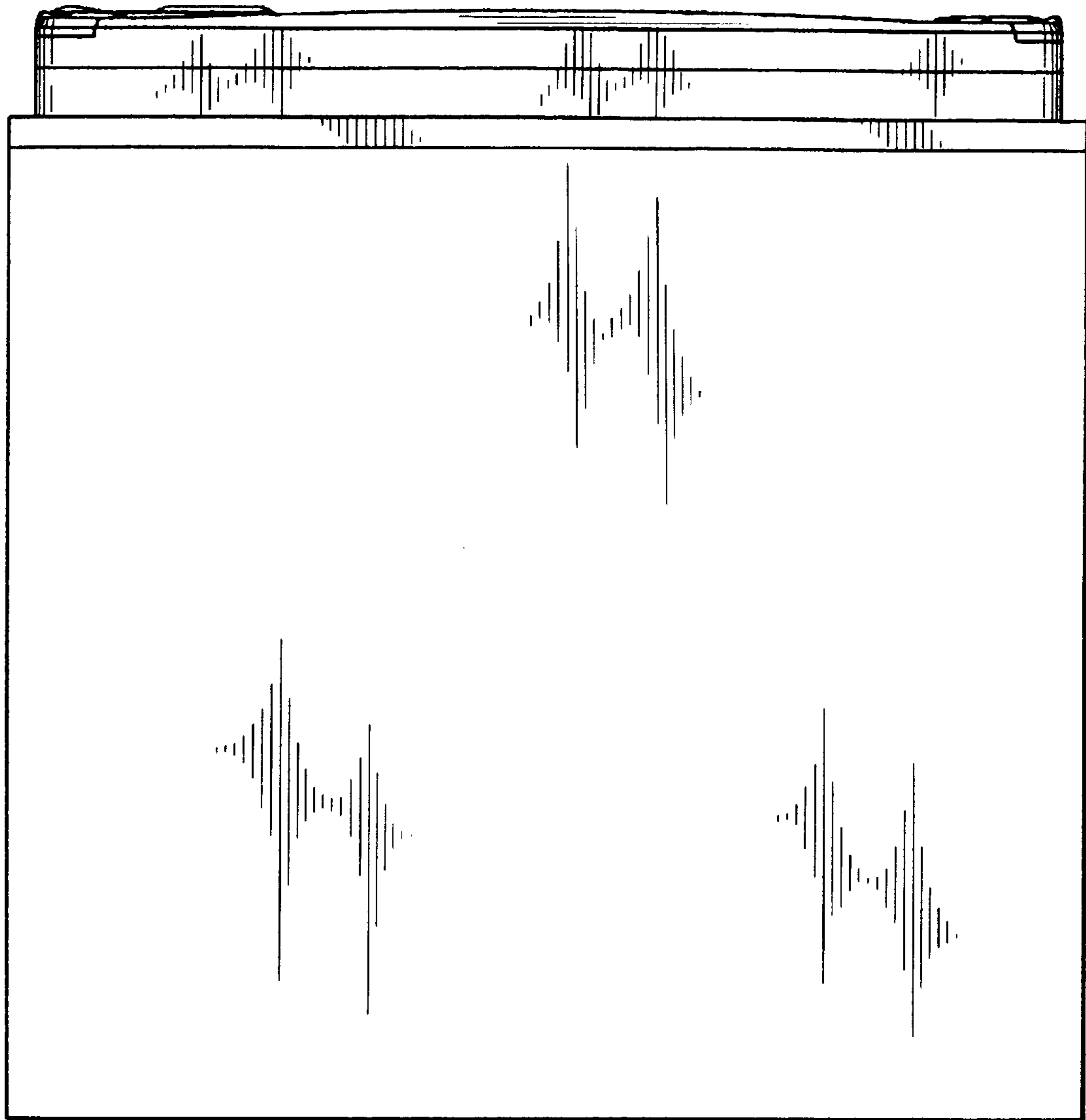

FIG. 8

