



US00D446682B1

(12) **United States Design Patent**
Au

(10) **Patent No.:** **US D446,682 S**

(45) **Date of Patent:** **** Aug. 21, 2001**

(54) **DRINK MIXER**

(75) Inventor: **Tat-Fu Au, Kwai Chung (HK)**

(73) Assignee: **Fatia Industrial Company Limited**

(**) Term: **14 Years**

(21) Appl. No.: **29/132,983**

(22) Filed: **Nov. 21, 2000**

(51) **LOC (7) Cl.** **31-00**

(52) **U.S. Cl.** **D7/379**

(58) **Field of Search** D7/376-386; 366/129,
366/130, 206; 241/282.1

(56) **References Cited**

U.S. PATENT DOCUMENTS

D. 118,225	*	12/1939	Barnes et al.	D7/379
D. 158,947	*	6/1950	Ernst	D7/379
D. 163,376	*	5/1951	Ernst	D7/379
D. 169,829	*	6/1953	Seyfried et al.	D7/379
D. 175,338	*	8/1955	Ernst	D7/379
D. 207,407	*	4/1967	Rogenski	D7/379

D. 365,496	*	12/1995	McLinden et al.	D7/379
D. 413,226	*	8/1999	Barker	D7/379
2,626,132	*	1/1953	Reed	241/282.1
2,696,370	*	12/1954	Gafford	366/206

* cited by examiner

Primary Examiner—Caron D. Veynar

(74) *Attorney, Agent, or Firm*—Burns, Doane, Swecker & Mathis, L.L.P.

(57) **CLAIM**

The ornamental design of a “drink mixer”, as shown and described.

DESCRIPTION

FIG. 1 is a front view of a “drink mixer” showing my design; FIG. 2 is a back view thereof; FIG. 3 is a left side view thereof, FIG. 4 is a right side view thereof; FIG. 5 is a top plan view thereof, FIG. 6 is a bottom view thereof; and, FIG. 7 is a perspective view thereof.

1 Claim, 2 Drawing Sheets

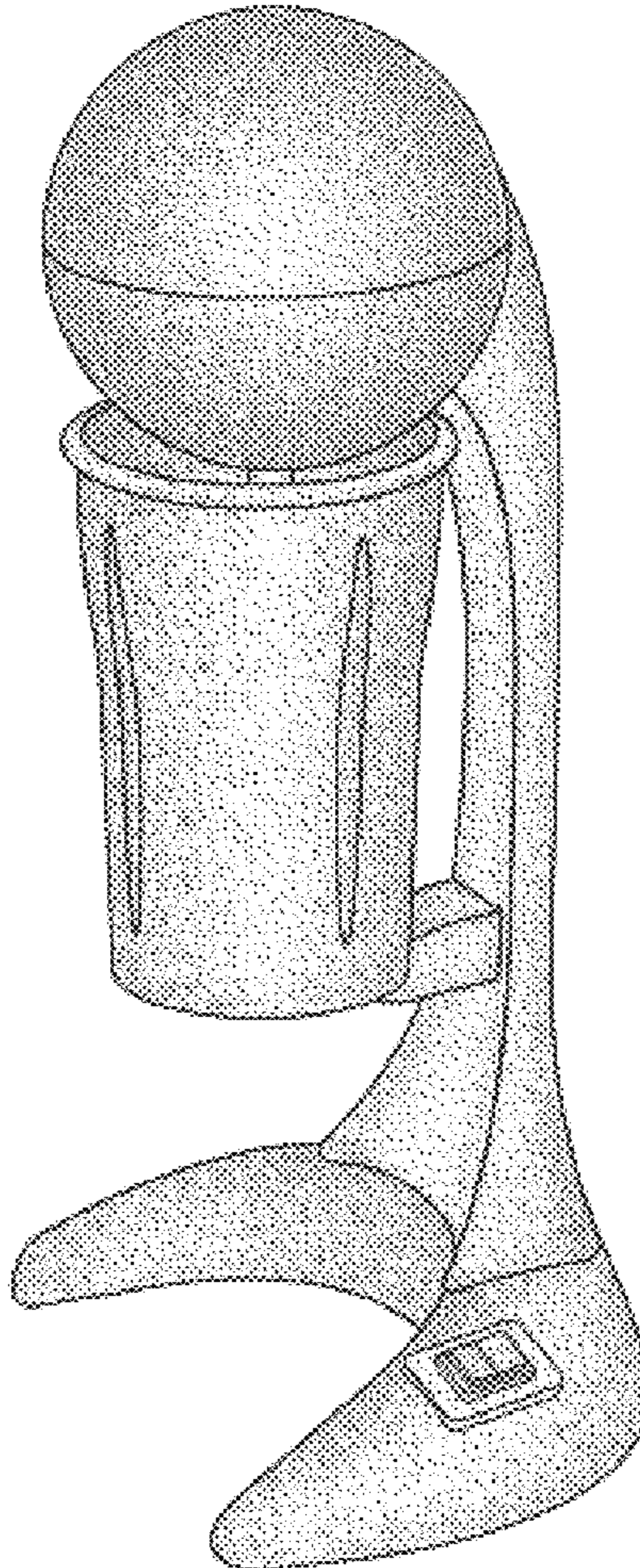

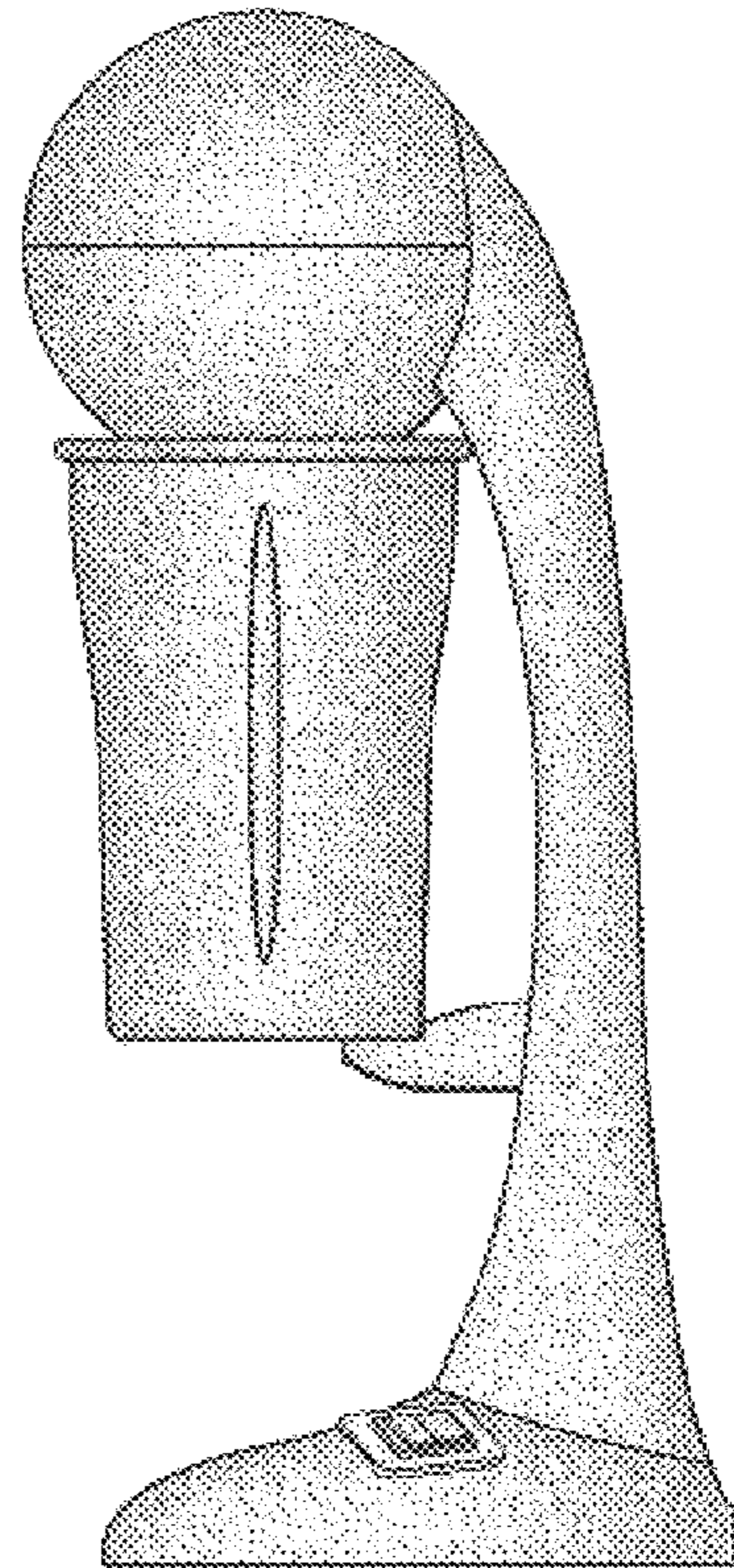
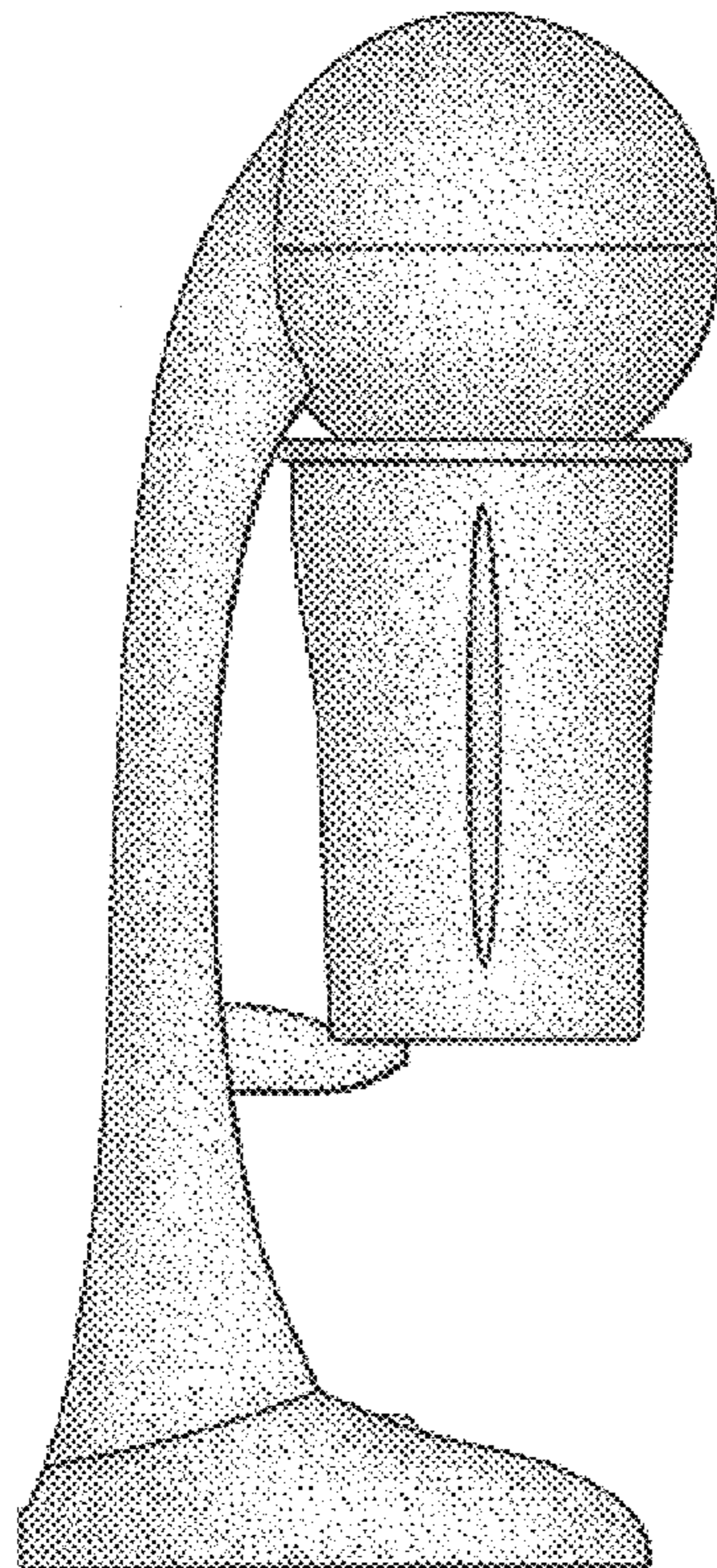
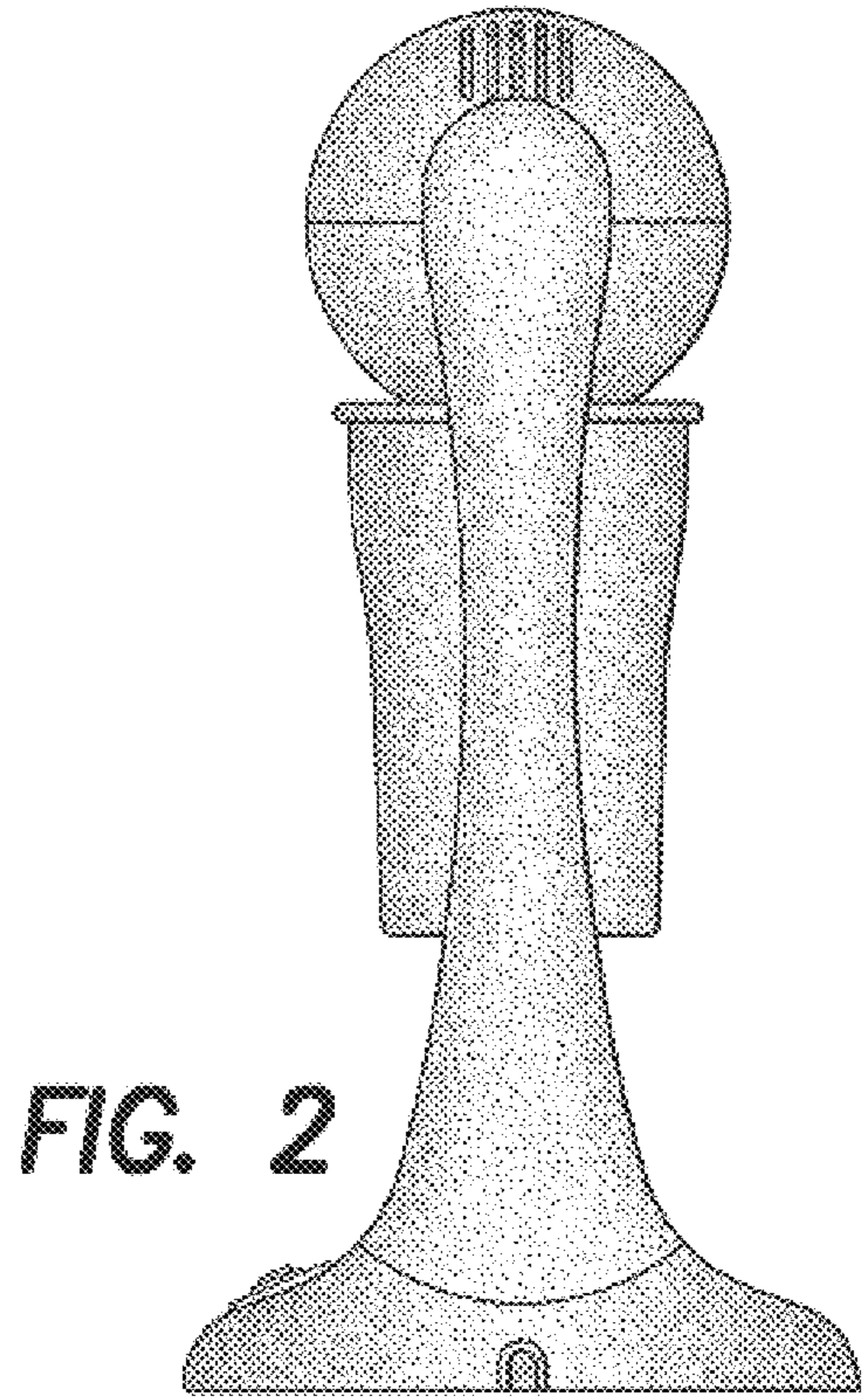
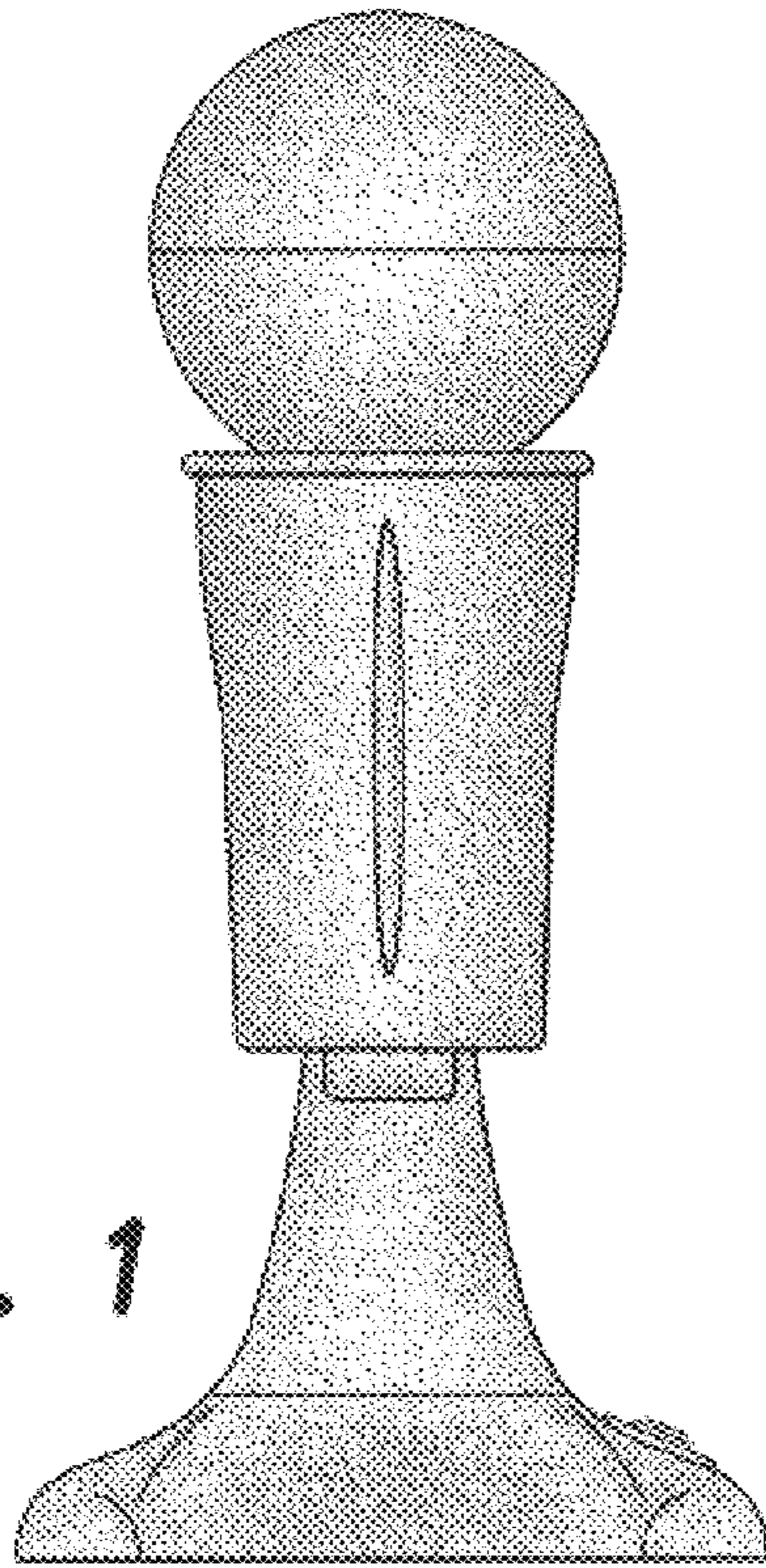

FIG. 3

FIG. 4

FIG. 5

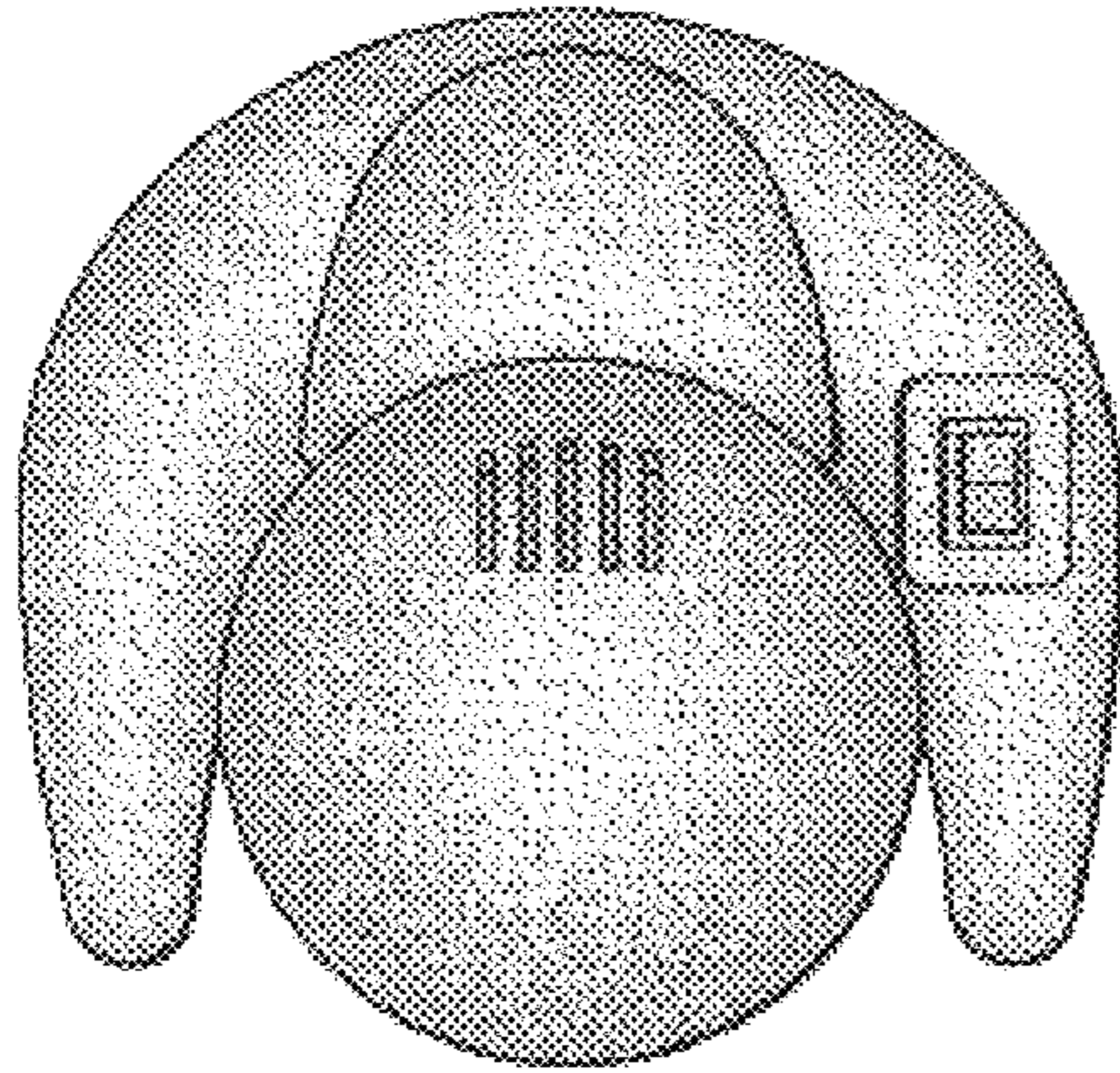

FIG. 5

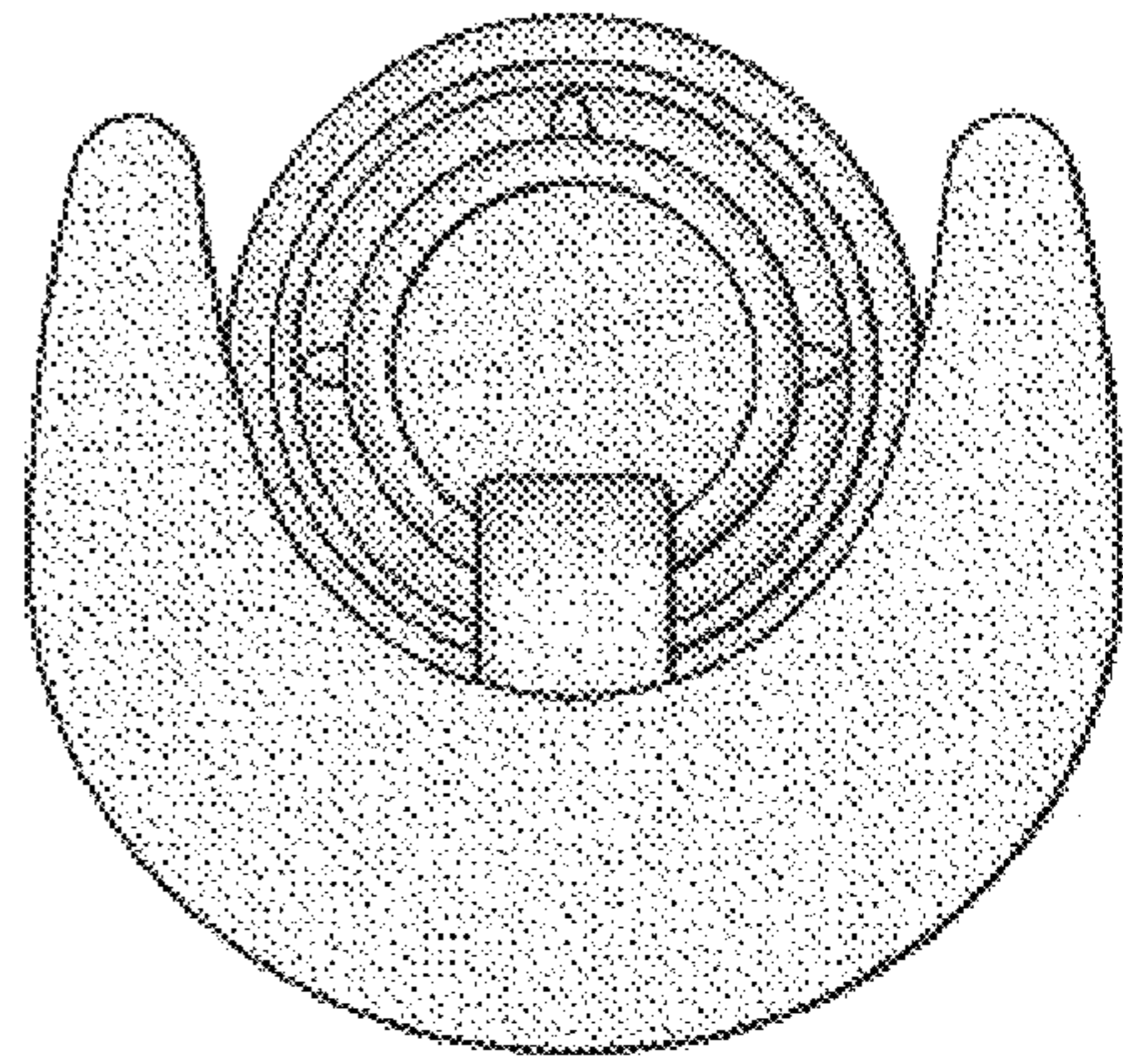

FIG. 6

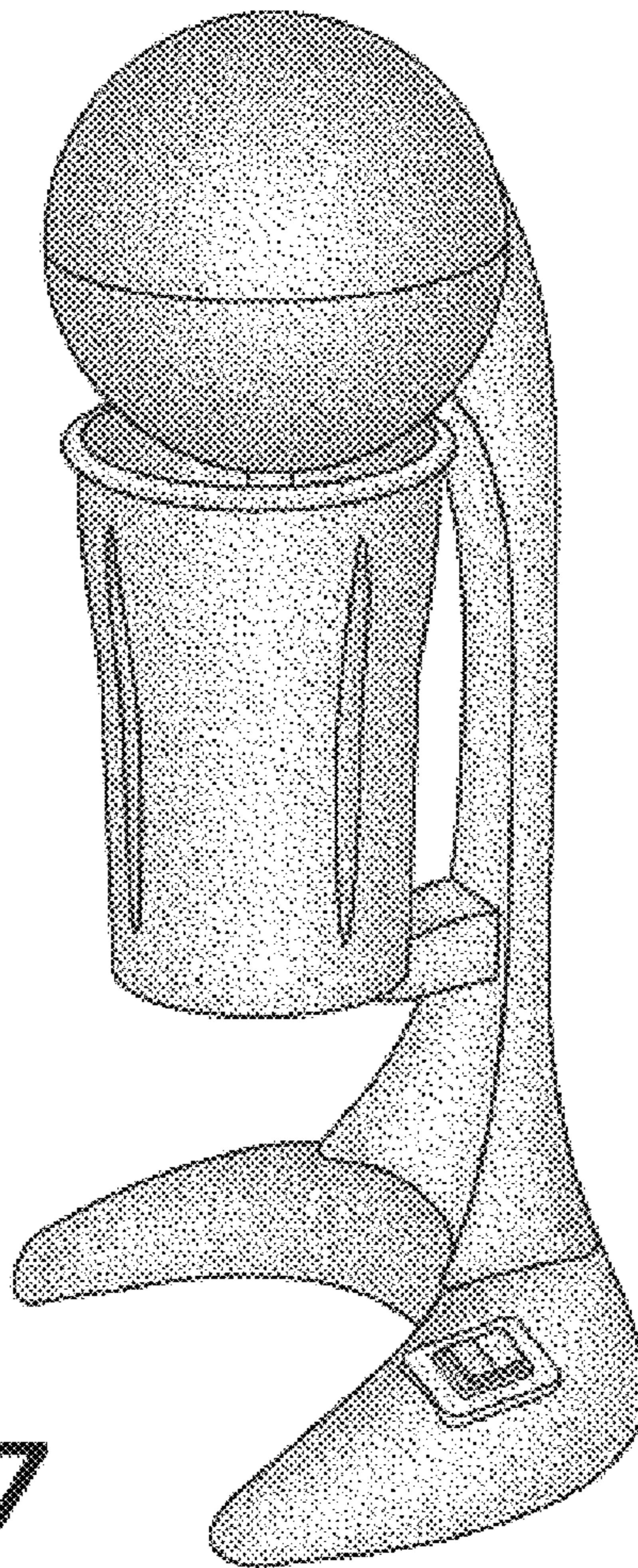

FIG. 7