



US00D446568B1

(12) **United States Design Patent**
Peterson

(10) **Patent No.:** **US D446,568 S**

(45) **Date of Patent:** **** Aug. 14, 2001**

(54) **INFLATABLE SHADED FLOAT**

(75) **Inventor:** **Leroy L. Peterson, Omaha, NE (US)**

(73) **Assignee:** **Sportsstuff, Inc., Omaha, NE (US)**

(**) **Term:** **14 Years**

(21) **Appl. No.:** **29/117,690**

(22) **Filed:** **Jan. 27, 2000**

(51) **LOC (7) Cl.** **21-06**

(52) **U.S. Cl.** **D21/803**

(58) **Field of Search** D21/801, 802,
D21/803, 808, 809; 441/40, 66, 67, 129,
130, 131, 132; 482/111

(56) **References Cited**

U.S. PATENT DOCUMENTS

D. 393,681 * 4/1998 Peterson D21/803

D. 435,619 * 12/2000 Peterson D21/803

* cited by examiner

Primary Examiner—Kay H. Chin

(74) *Attorney, Agent, or Firm*—Henderson & Sturm LLP

(57) **CLAIM**

The ornamental design for an inflatable shaded float, as shown and described.

DESCRIPTION

FIG. 1 is a perspective view of the inflatable shaded float showing my new design;

FIG. 2 is a top plan view thereof;

FIG. 3 is a left side elevational view thereof;

FIG. 4 is a right side elevational view thereof;

FIG. 5 is a front elevational view thereof;

FIG. 6 is a rear elevational view thereof; and,

FIG. 7 is a bottom plan view thereof.

1 Claim, 4 Drawing Sheets

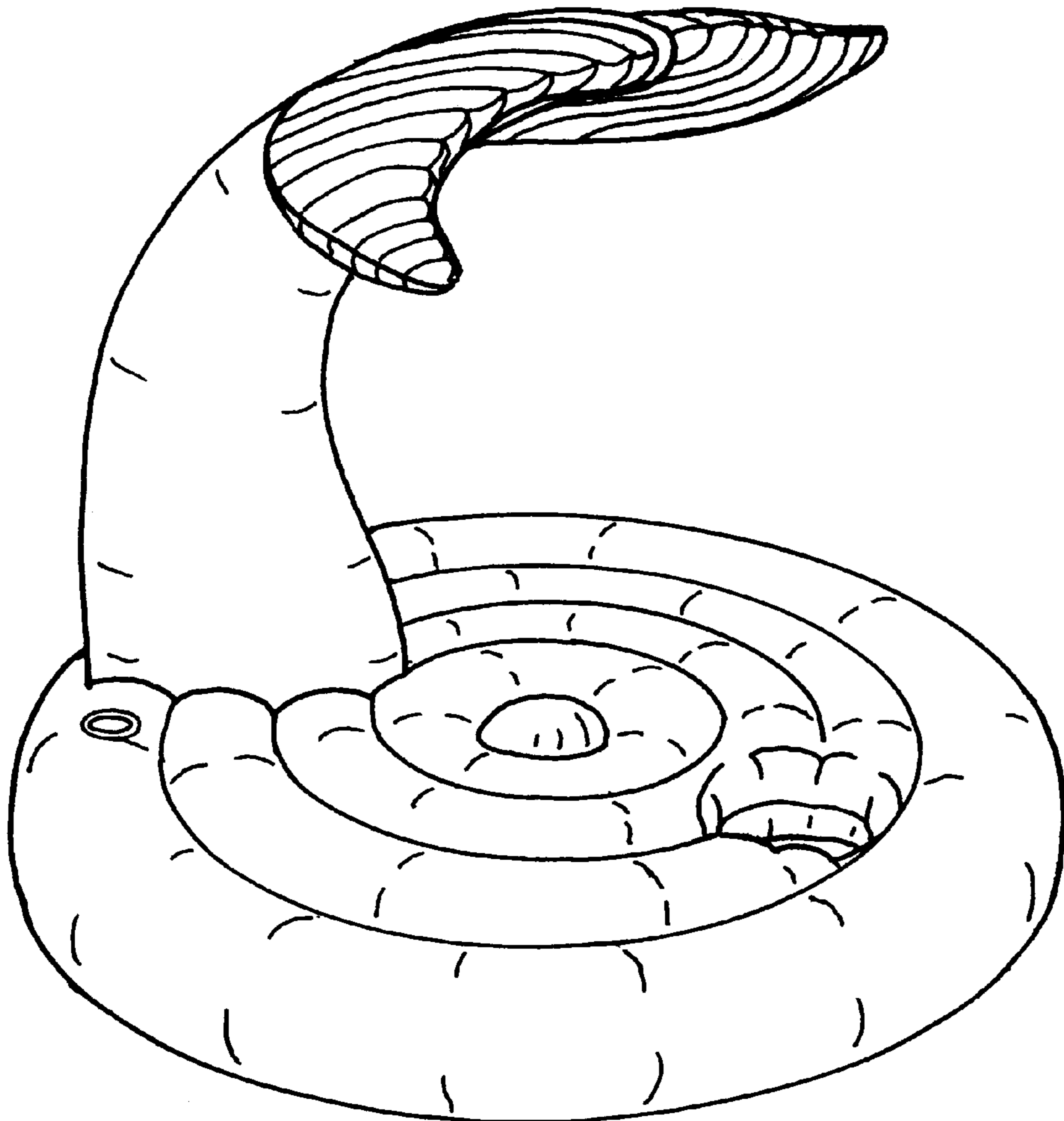

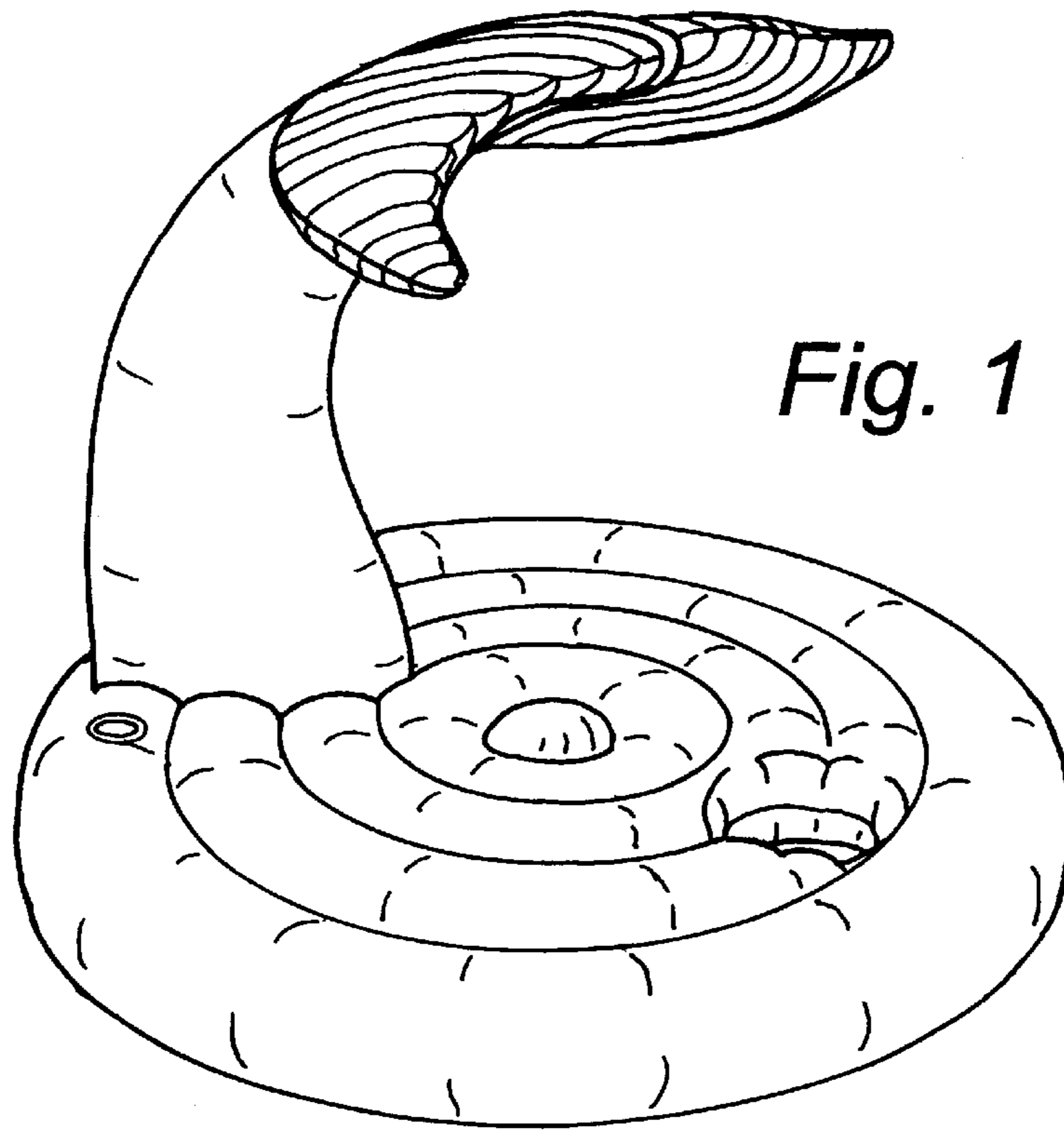

Fig. 1

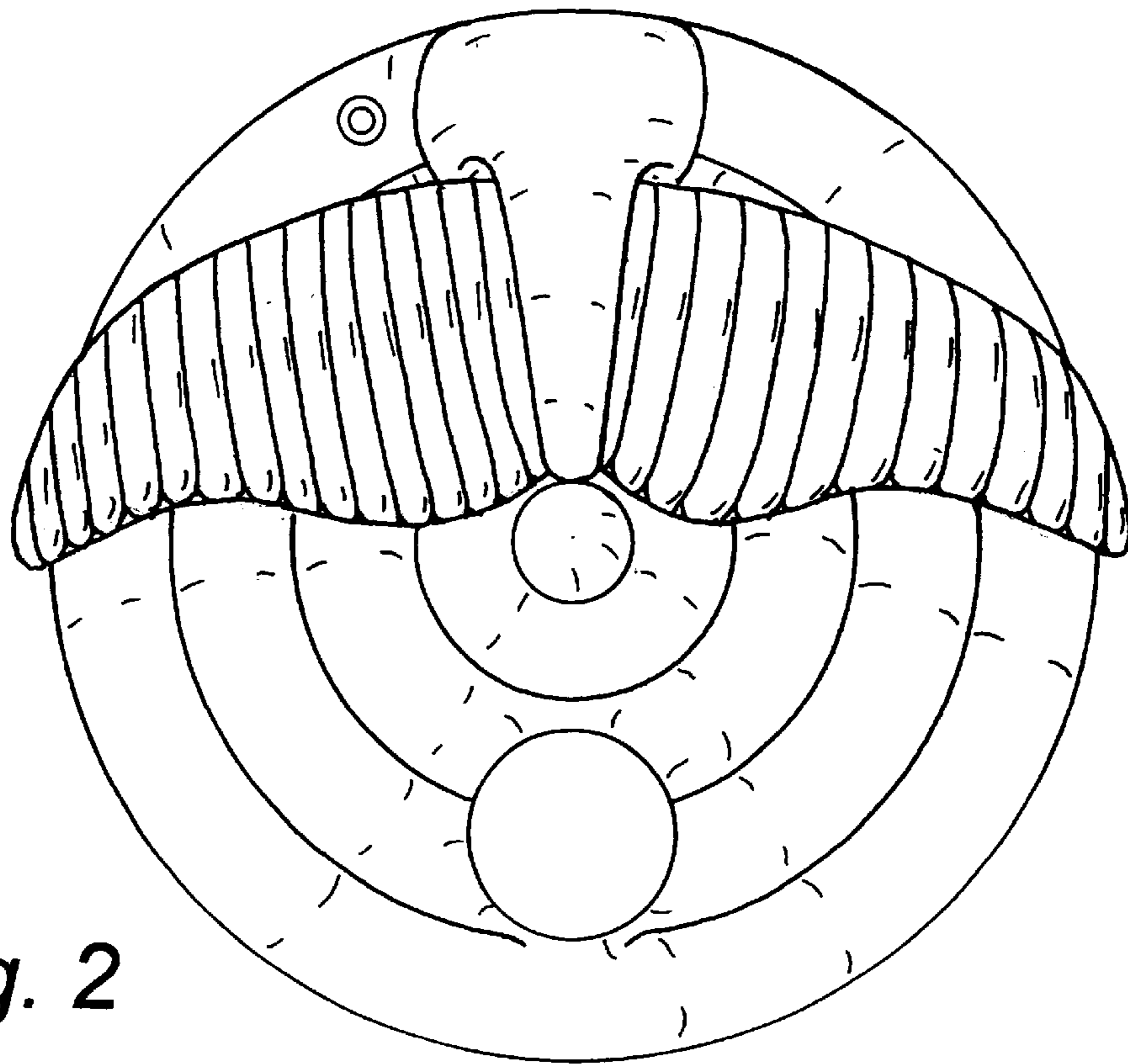

Fig. 2

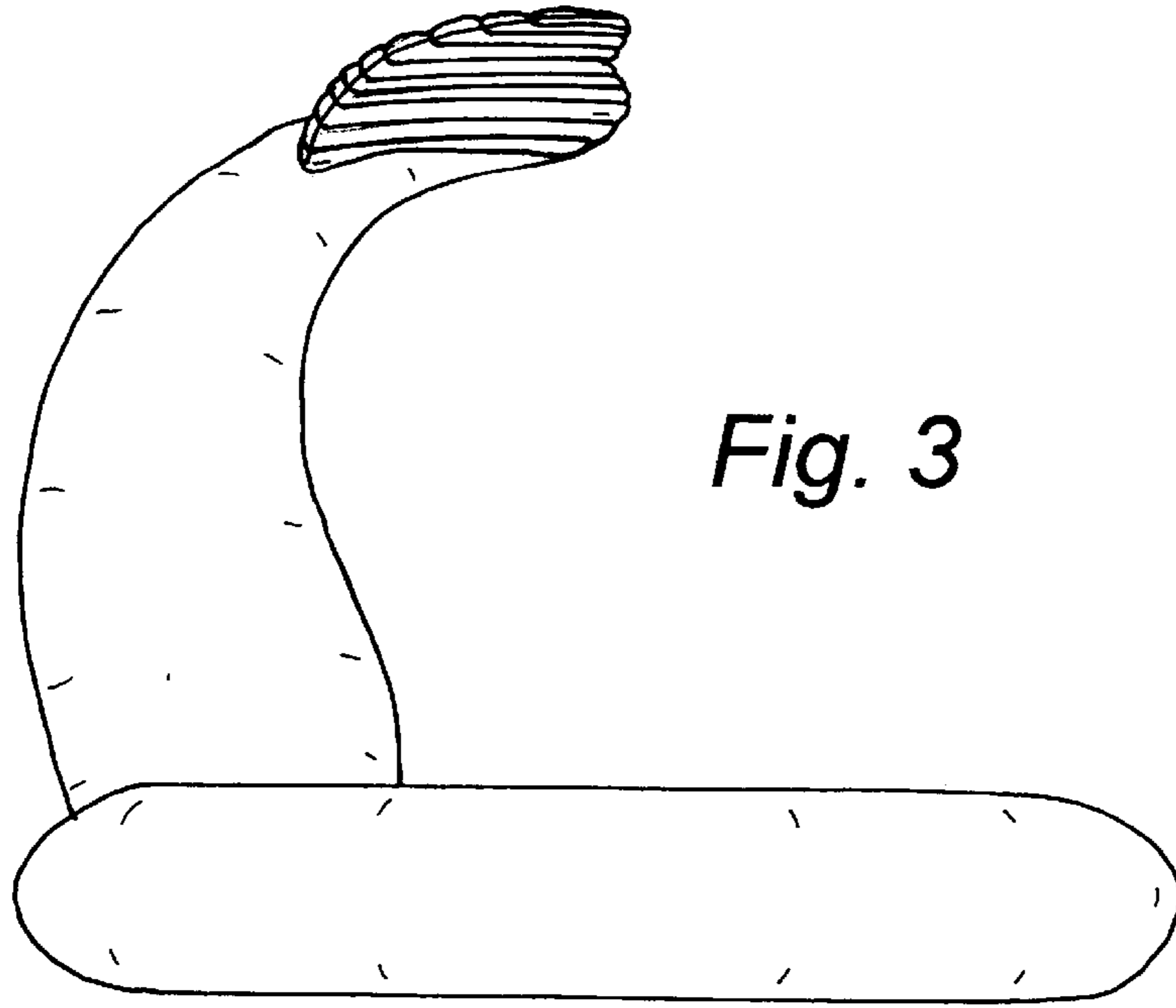

Fig. 3

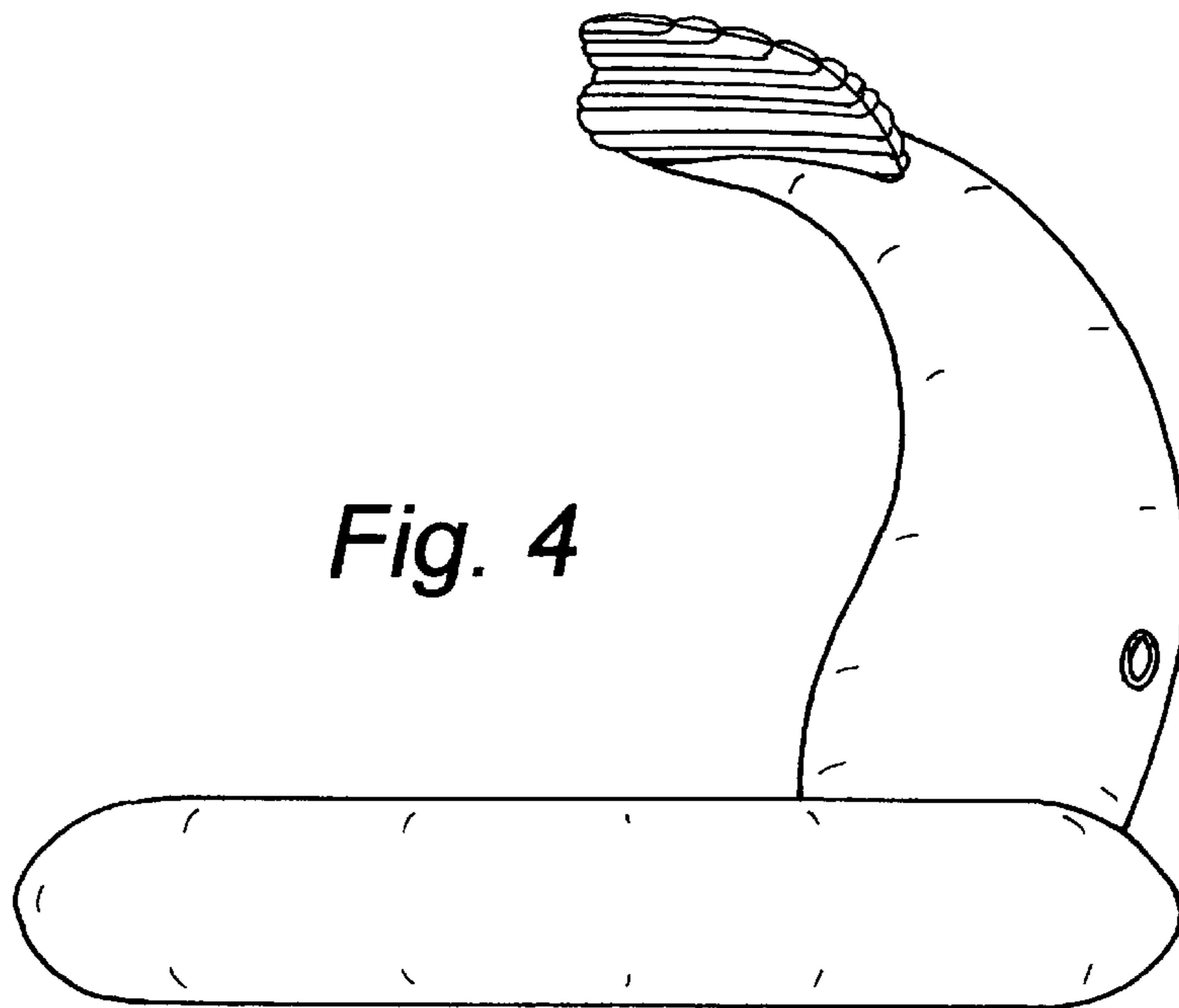

Fig. 4

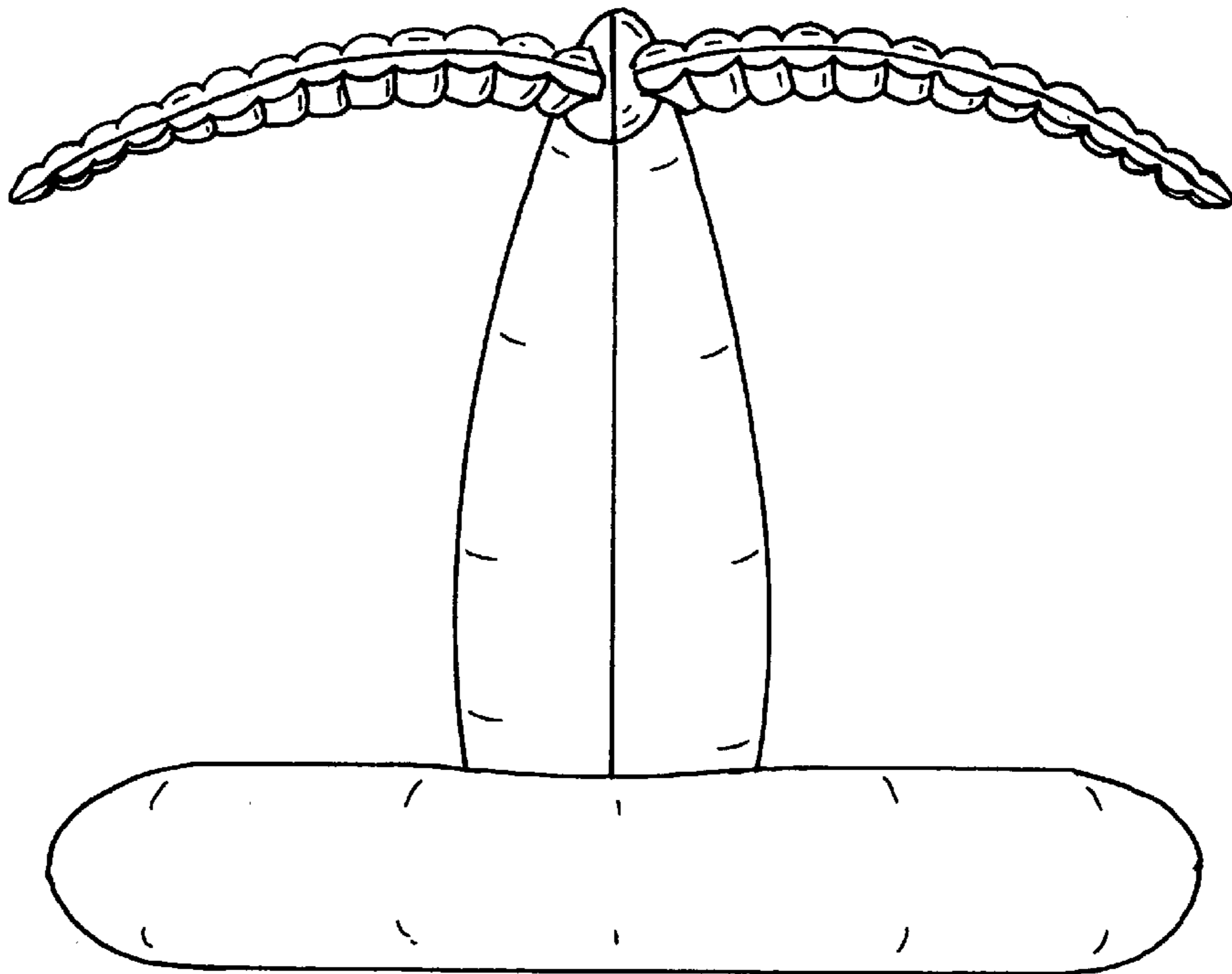

Fig. 5

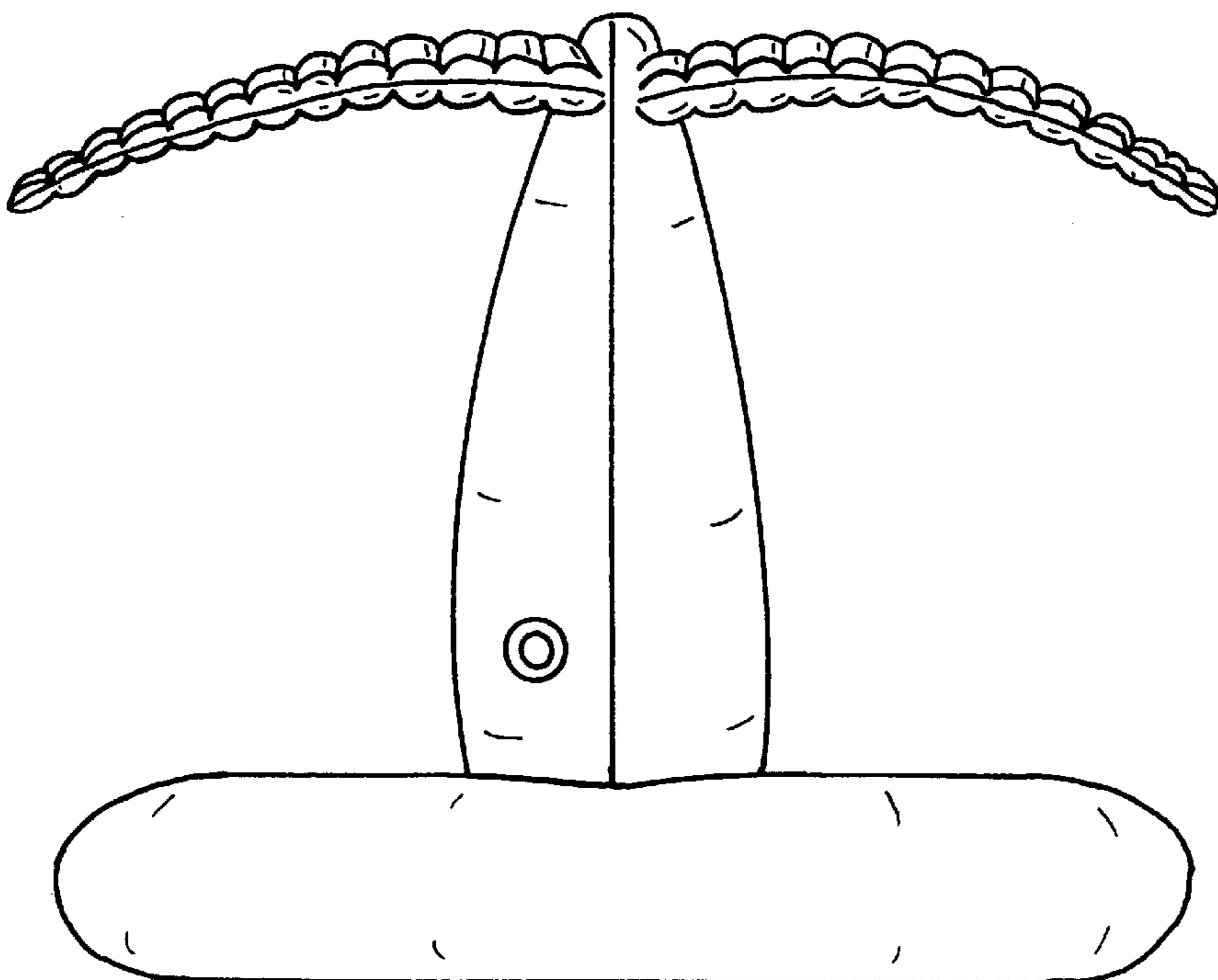

Fig. 6

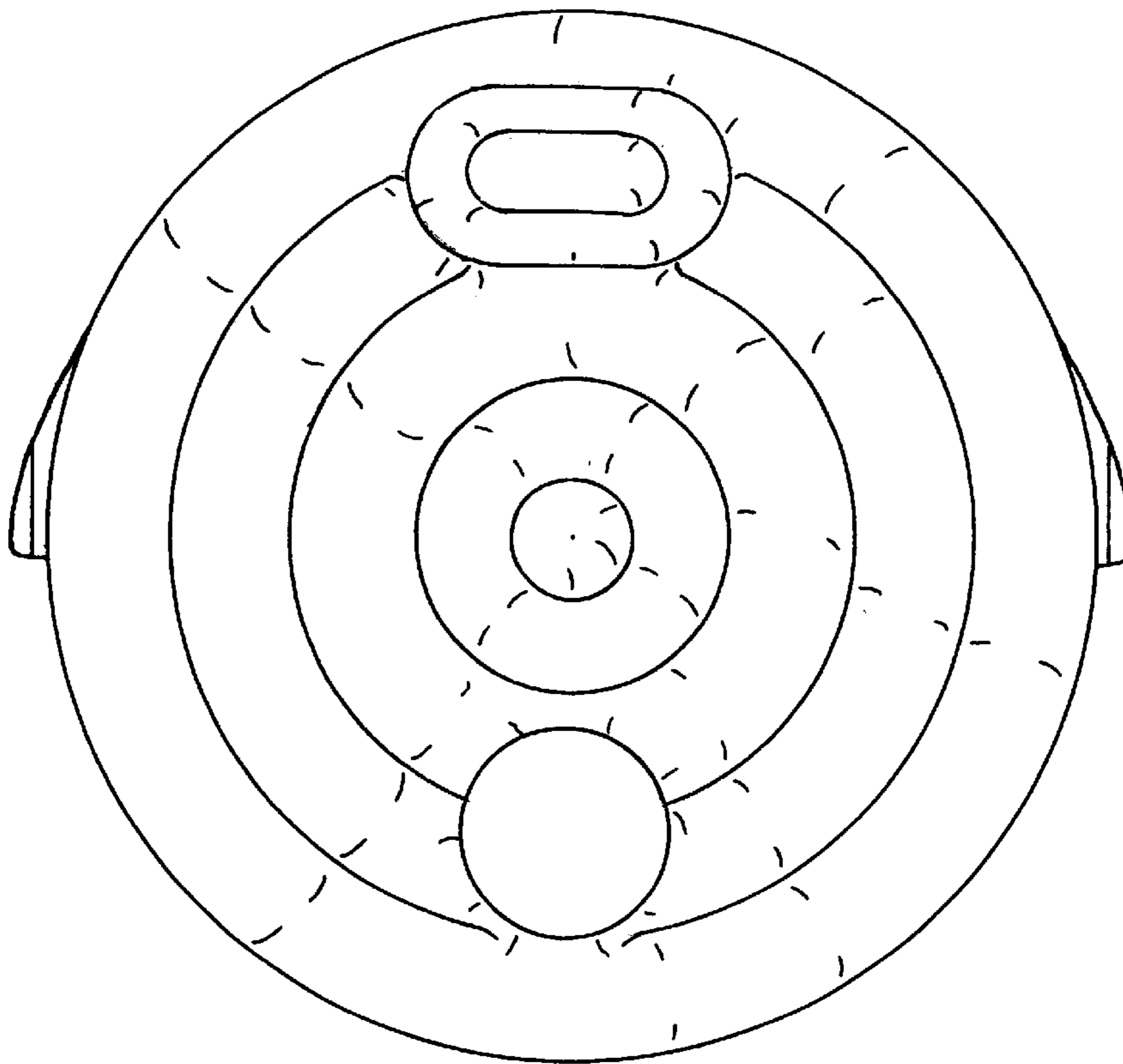

Fig. 7