



US00D446455B1

(12) **United States Design Patent**  
**McGowan**

(10) **Patent No.:** **US D446,455 S**

(45) **Date of Patent:** **\*\* Aug. 14, 2001**

(54) **PLASTIC BOTTLE BOTTOM PORTION**

D. 413,520 \* 9/1999 Comper ..... D9/553

(75) Inventor: **Shebriiniah McGowan**, Hampton, GA  
(US)

\* cited by examiner

(73) Assignee: **Ball Corporation**, Broomfield, CO  
(US)

*Primary Examiner*—Ted Shooman

*Assistant Examiner*—Daniel Bui

(\*\*) Term: **14 Years**

(74) *Attorney, Agent, or Firm*—Brinks Hofer Gilson & Lione

(21) Appl. No.: **29/129,094**

(57) **CLAIM**

(22) Filed: **Sep. 7, 2000**

I claim the ornamental design for a plastic bottle bottom portion, as shown and described.

(51) **LOC (7) Cl.** ..... **09-01**

**DESCRIPTION**

(52) **U.S. Cl.** ..... **D9/520; D9/549**

FIG. 1 is a front elevation view of the plastic bottle bottom portion showing my new design;

(58) **Field of Search** ..... D9/500, 503, 516,

FIG. 2 is a left side elevation view thereof;

D9/520, 549, 558, 574, 575; 215/237, 274,

FIG. 3 is a rear elevation view thereof;

277, 316

FIG. 4 is a right side elevation view thereof;

(56) **References Cited**

FIG. 5 is a top plan view thereof;

**U.S. PATENT DOCUMENTS**

FIG. 6 is a bottom plan view thereof; and,

D. 315,677 \* 3/1991 Vidarsson ..... D9/349

FIG. 7 is a sectional view thereof, taken along line 7—7.

D. 326,811 \* 6/1992 Messer ..... D9/500

The broken lines are for illustrative purpose only and form no part of the design.

D. 403,959 \* 1/1999 Flancman ..... D9/434

D. 407,309 \* 3/1999 Flancman ..... D9/520

**1 Claim, 5 Drawing Sheets**

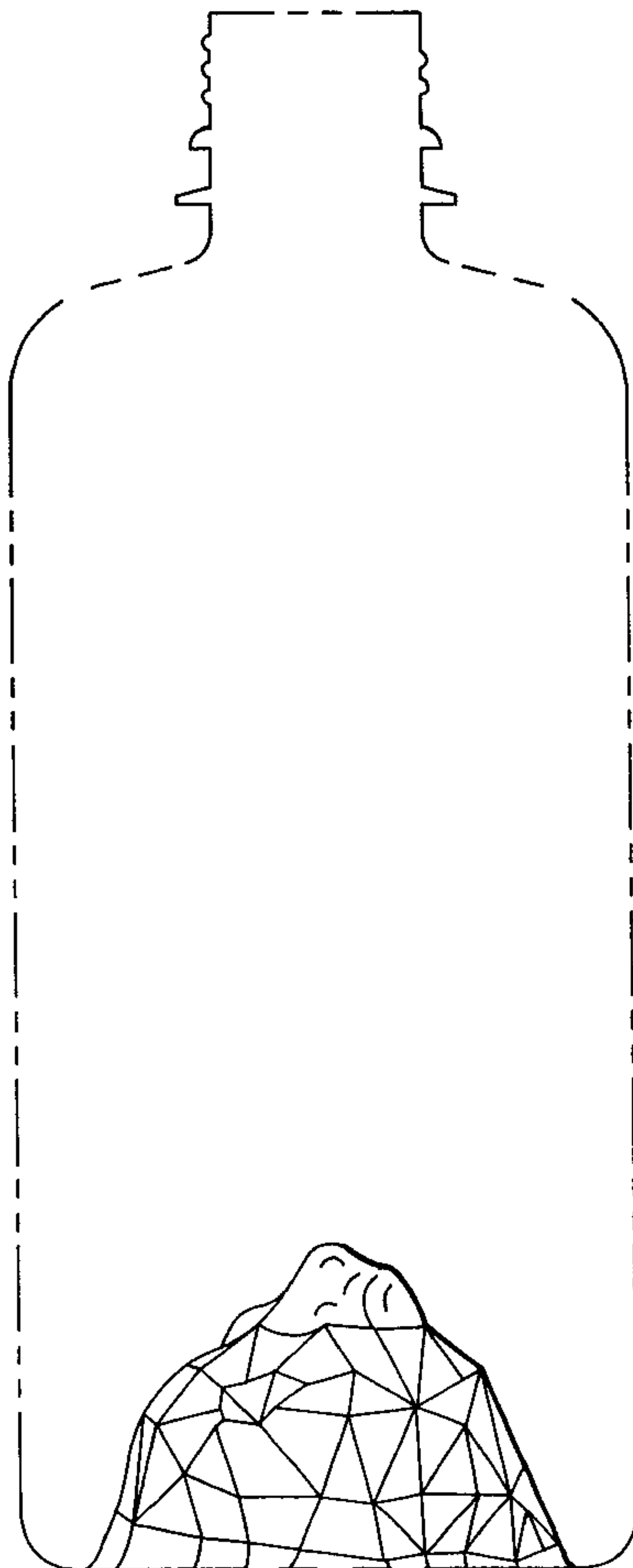

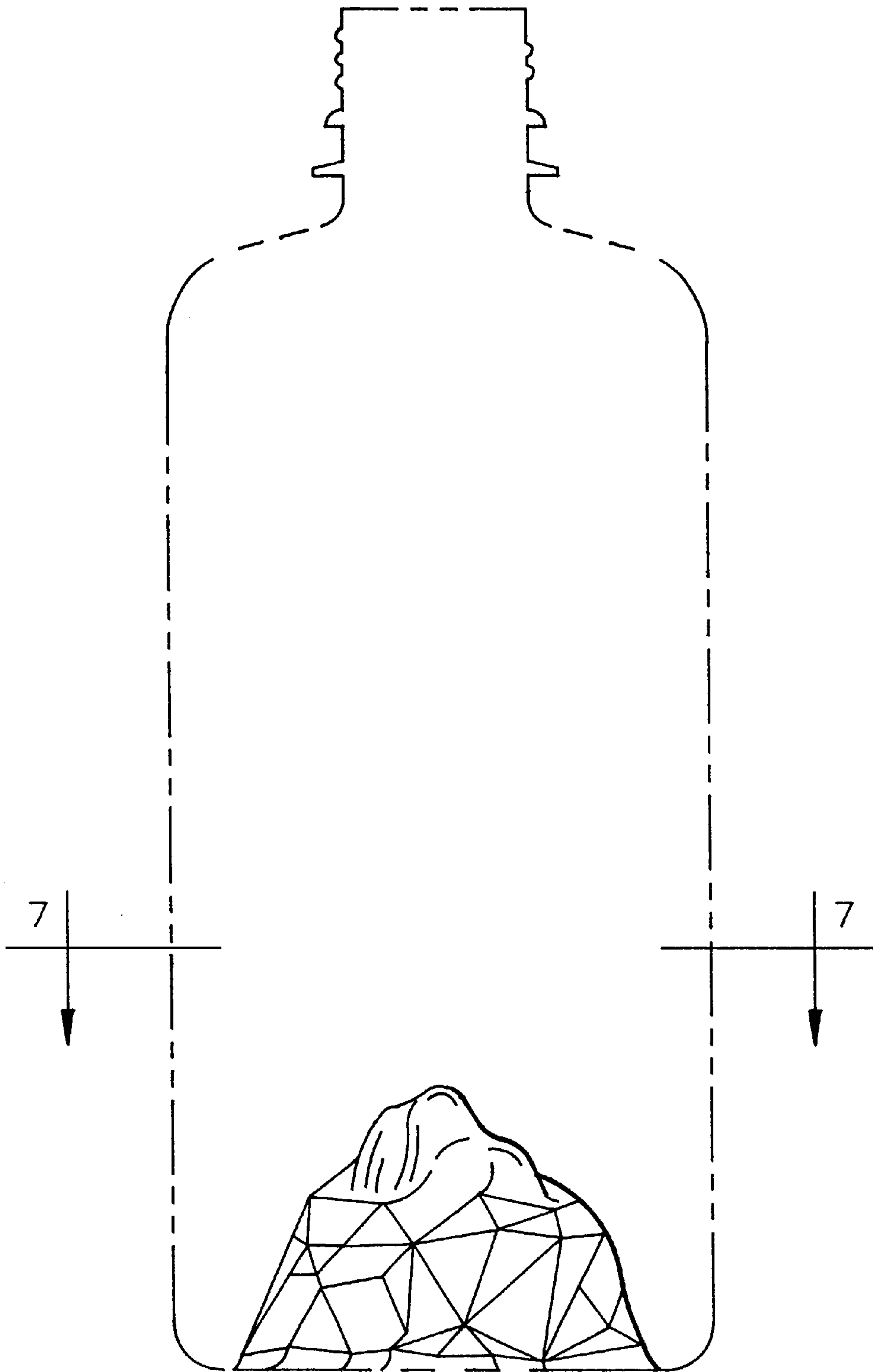

FIG. 1

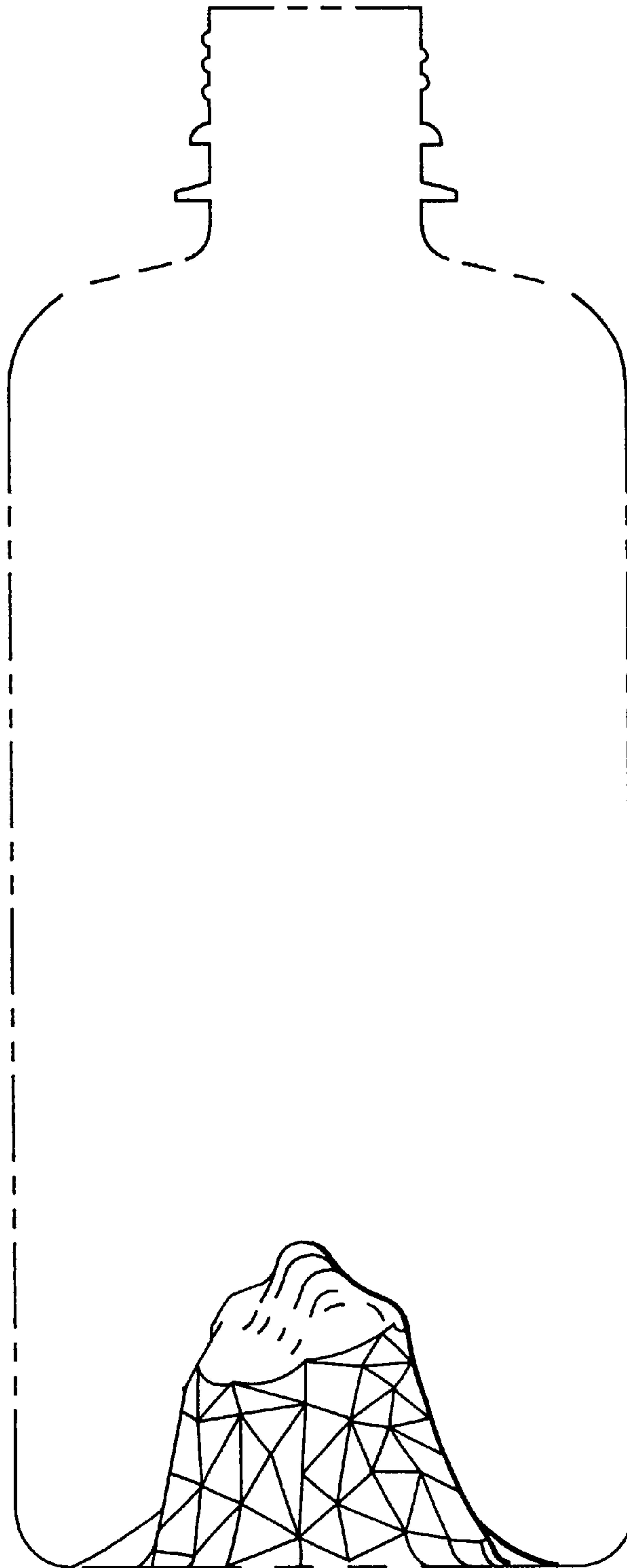

FIG. 2

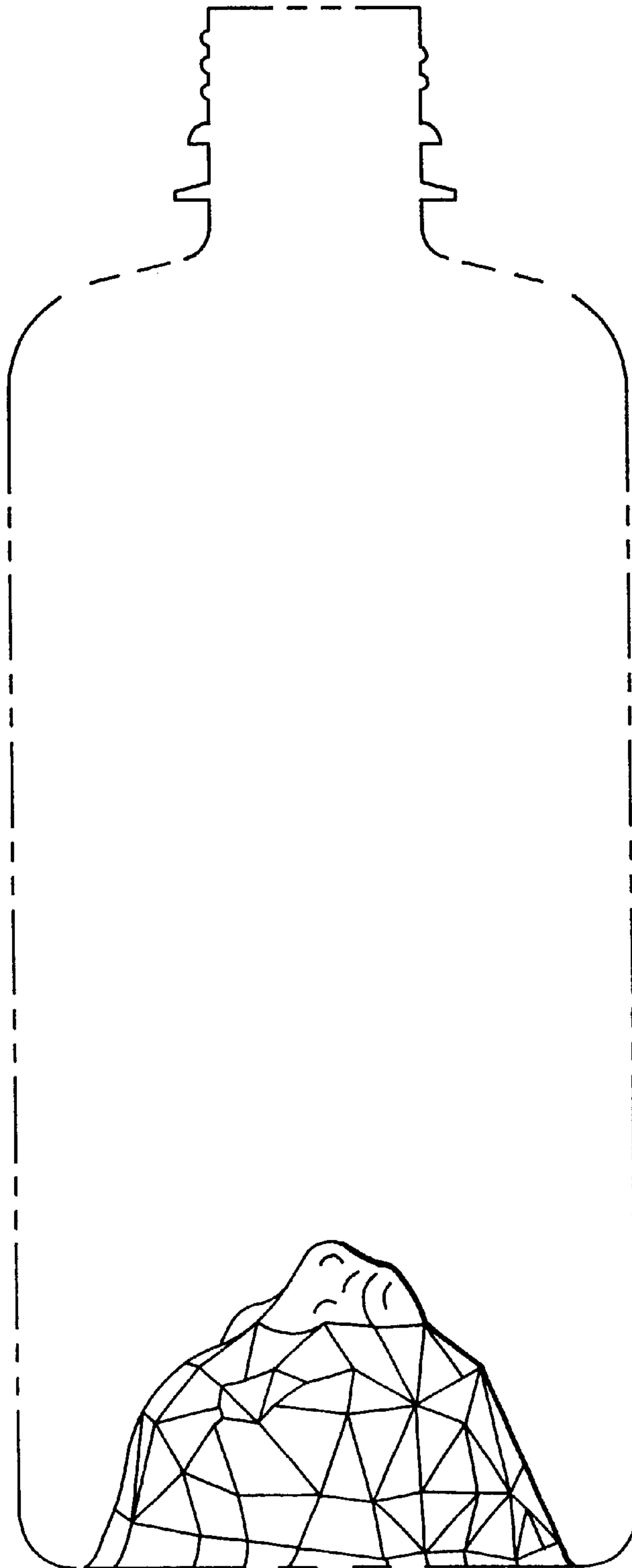

FIG. 3

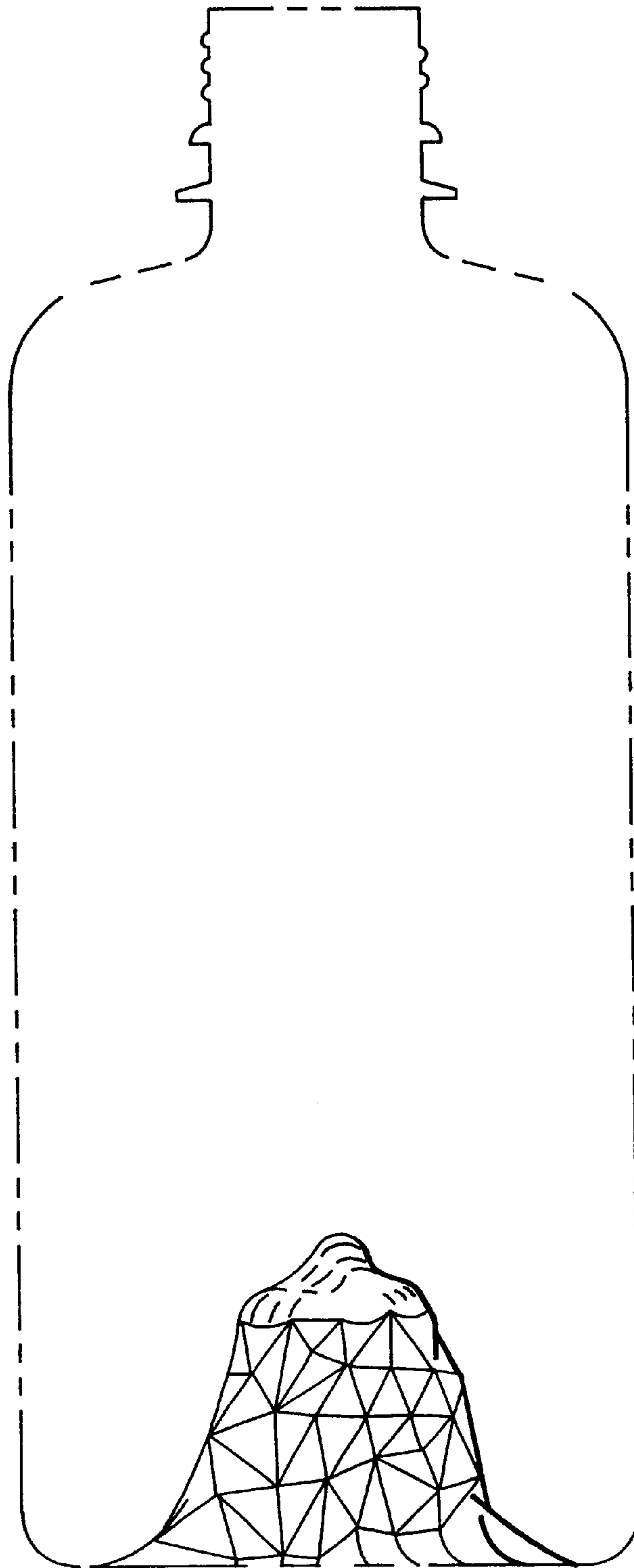

FIG. 4

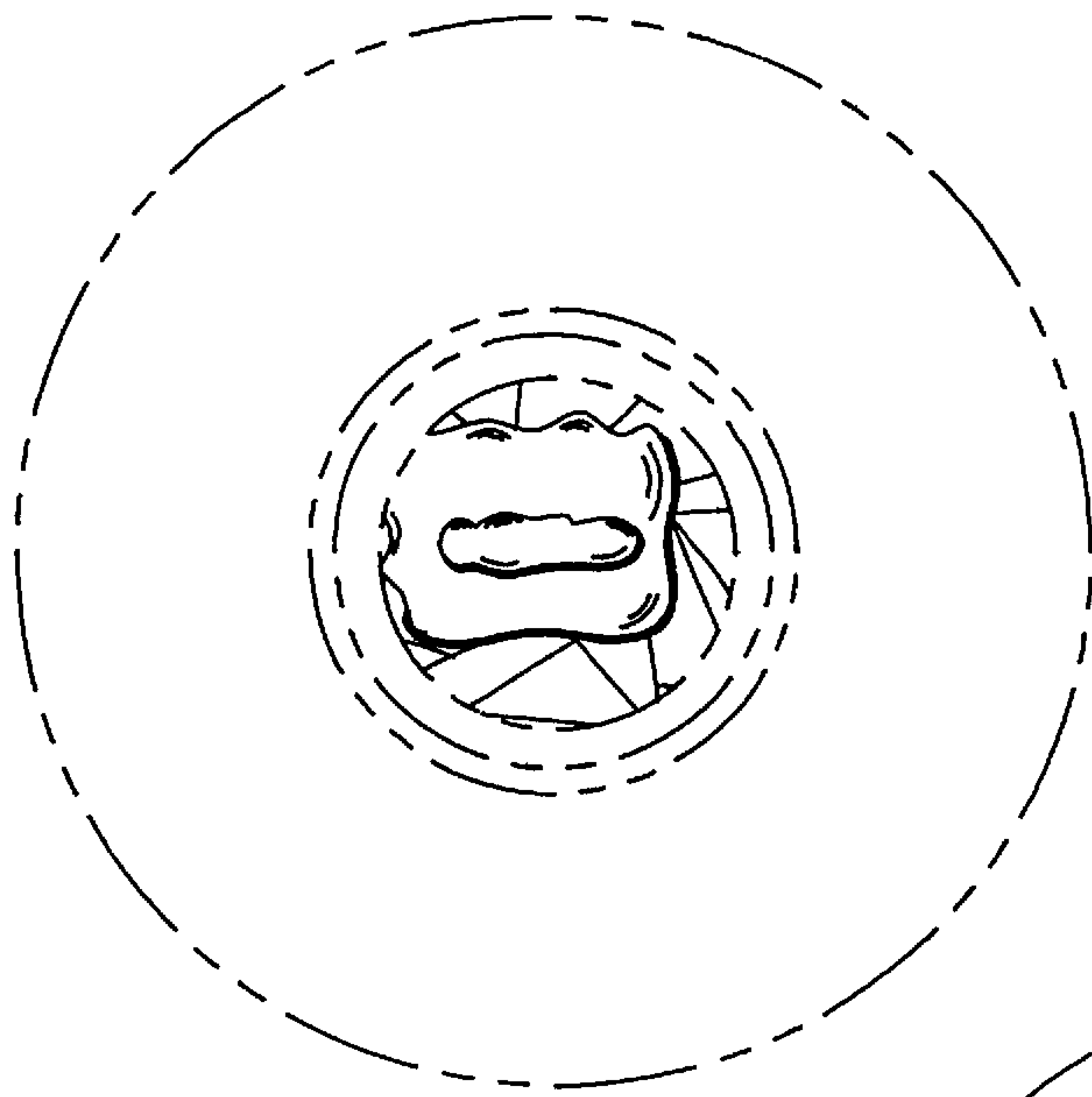

FIG. 5

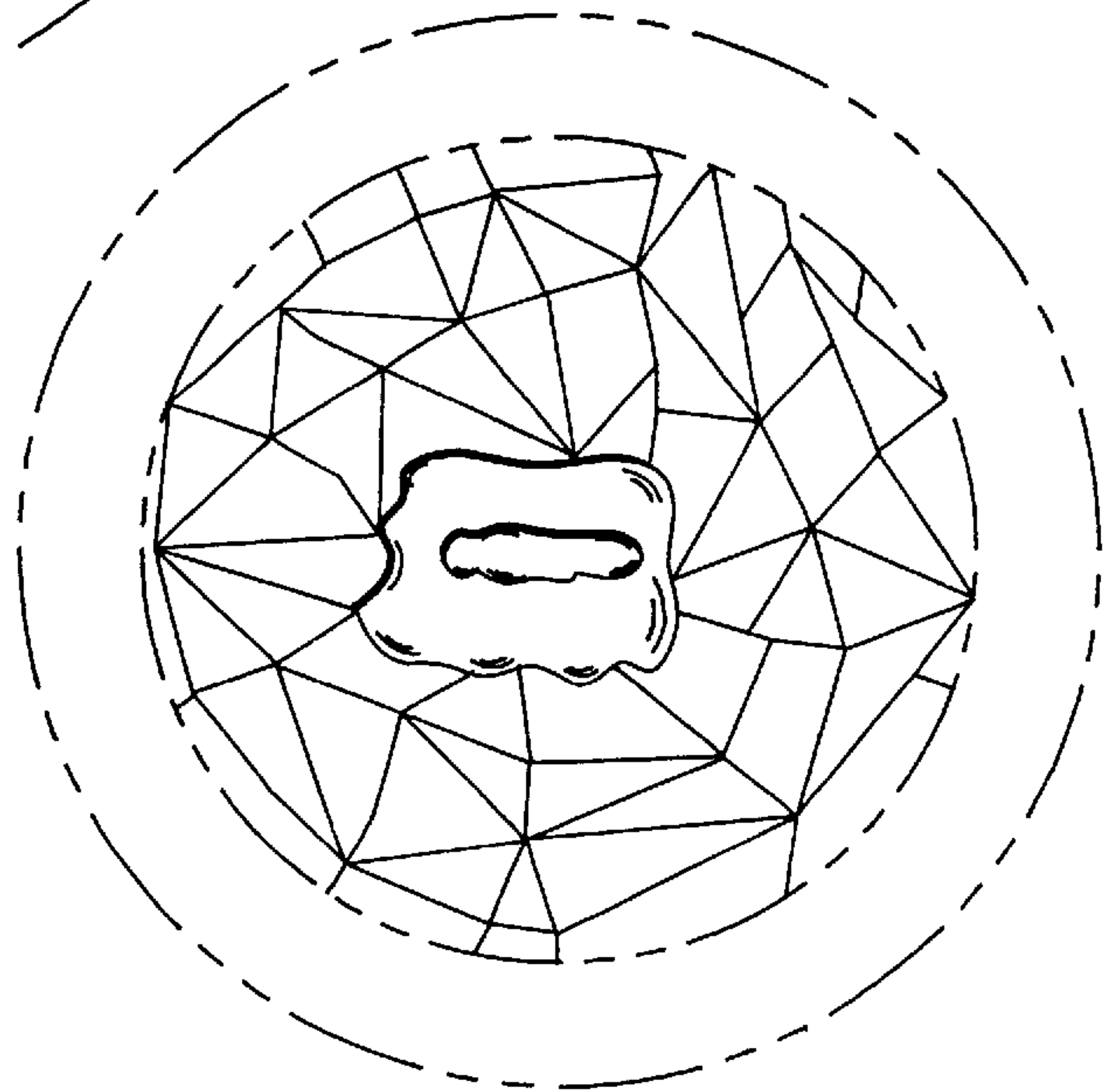

FIG. 6

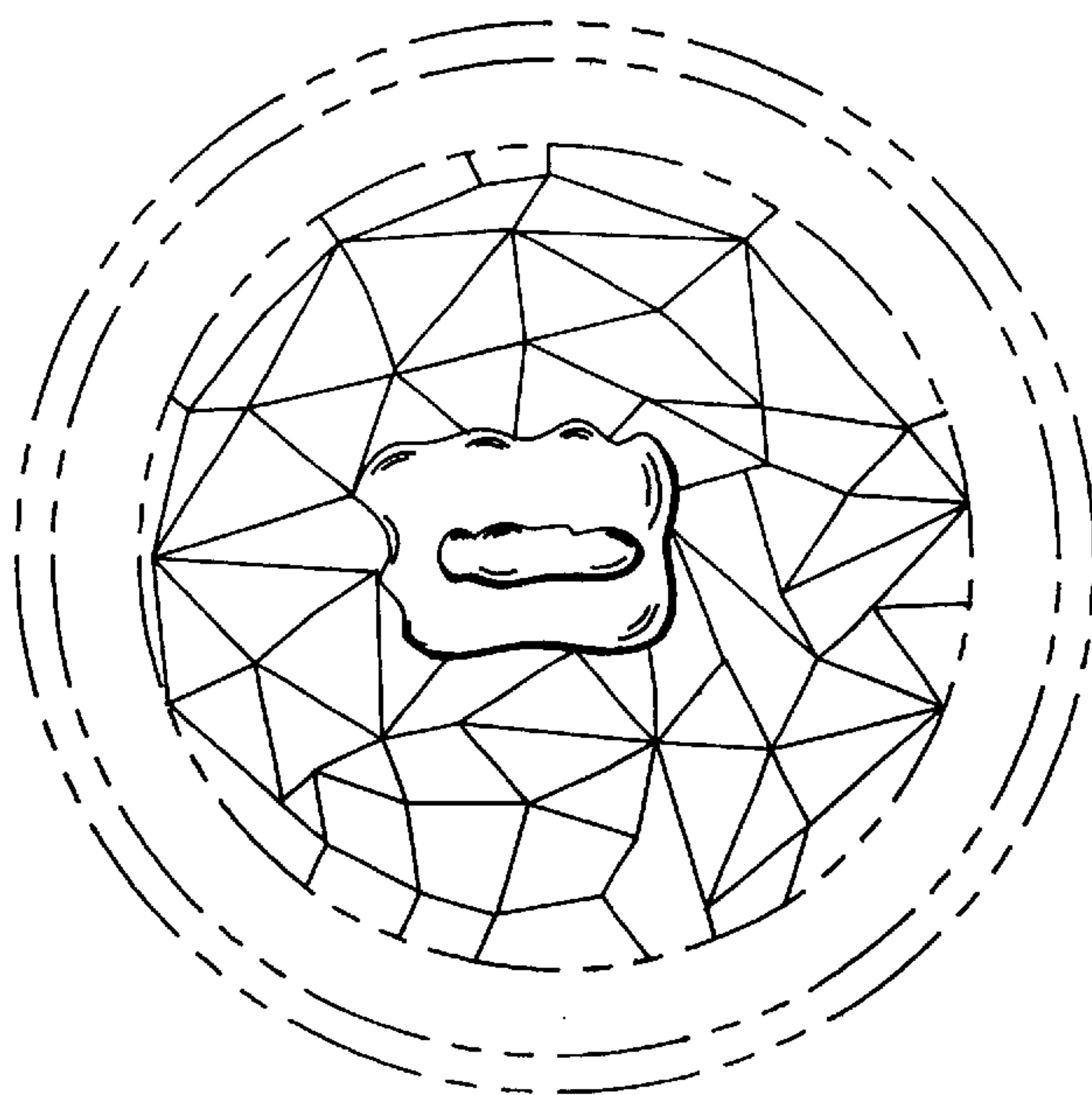

FIG. 7