



US00D446444B1

(12) **United States Design Patent**
Sterling et al.

(10) **Patent No.:** **US D446,444 S**

(45) **Date of Patent:** **** Aug. 14, 2001**

(54) **SUPPORT ROD**

(75) Inventors: **John R. Sterling**, Woodstock, IL (US);
Richard G. Kluge, Lake Geneva, WI (US)

(73) Assignee: **John Sterling Corporation**, Richmond, IL (US)

(**) Term: **14 Years**

(21) Appl. No.: **29/118,709**

(22) Filed: **Feb. 14, 2000**

(51) **LOC (7) Cl.** **08-01**

(52) **U.S. Cl.** **D8/367**

(58) **Field of Search** D6/566, 567; D8/367,
D8/370; 211/86.01, 181.1; 248/200, 205.1,
220.21, 220.31, 220.41, 302, 304, 309.1,
309.2, 205.3

(56) **References Cited**

U.S. PATENT DOCUMENTS

- D. 248,730 * 8/1978 Blann D6/566 X
- D. 310,479 * 9/1990 Speetzen D6/566 X
- D. 325,488 * 4/1992 Sheriff D6/566
- 2,614,701 * 10/1952 Mapson 248/220.41 X
- 4,008,871 * 2/1977 Rex 248/205.3

OTHER PUBLICATIONS

Adversing Slick: Heavy Duty Wall Organizer Value Pack, Model RP-0024, 2 pages, Form No. RP24-SI, John Sterling Corporation, Copyright 1991.

Advertising Slick: Home Storage & Organization, John Sterling Corporation, 1 page, Form No. ORGI-SL, Copyright 1997.

* cited by examiner

Primary Examiner—Brian N. Vinson

(74) *Attorney, Agent, or Firm*—Rockey, Milnamow & Katz, Ltd.

(57) **CLAIM**

The ornamental design for a support rod, as shown and described.

DESCRIPTION

FIG. 1 is a top, front, and right side perspective view of a support rod showing a first embodiment of my new design; FIG. 2 is a left side elevational view thereof; FIG. 3 is a top plan view thereof; FIG. 4 is a bottom plan view thereof; FIG. 5 is a front elevational view thereof; FIG. 6 is a top, front, and right side perspective view of a support rod showing a second embodiment of my new design; FIG. 7 is a left side elevational view thereof; FIG. 8 is a top plan view thereof; FIG. 9 is a bottom plan view thereof; FIG. 10 is a front elevational view thereof; FIG. 11 is a top, front, and right side perspective view of a support rod showing a third embodiment of my new design; FIG. 12 is a left side elevational view thereof; FIG. 13 is a top plan view thereof; FIG. 14 is a bottom plan view thereof; and, FIG. 15 is a front elevational view thereof.

1 Claim, 6 Drawing Sheets

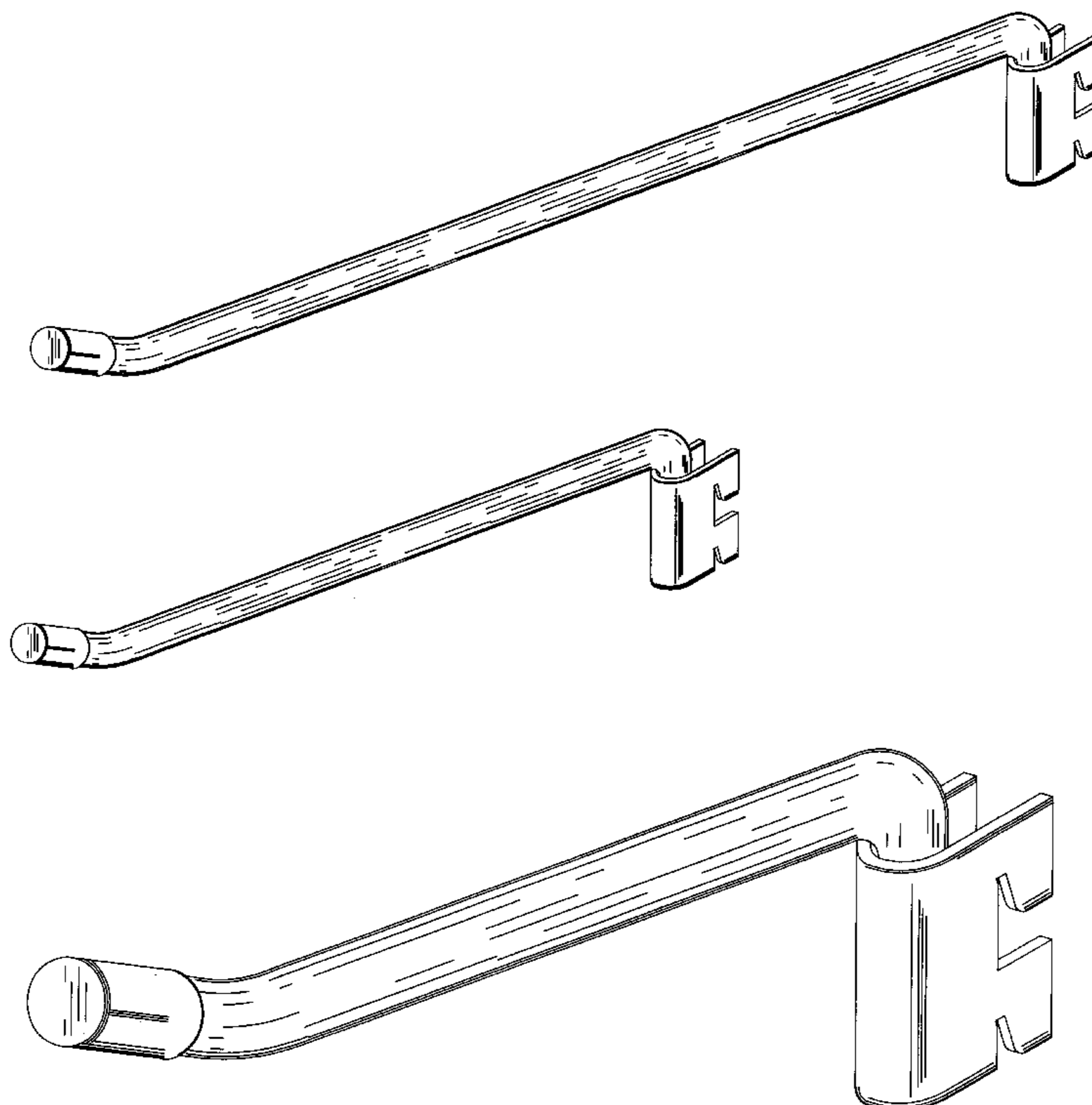

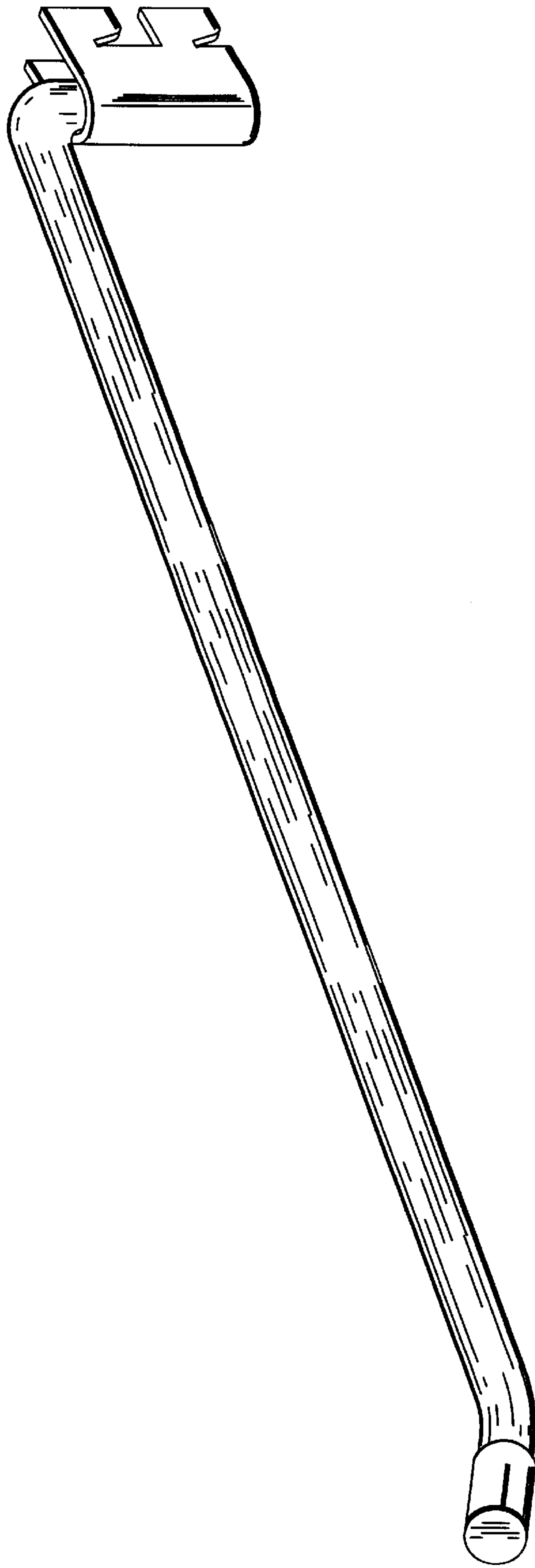

FIG. 1

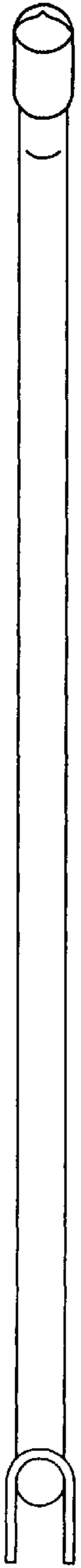

FIG. 3

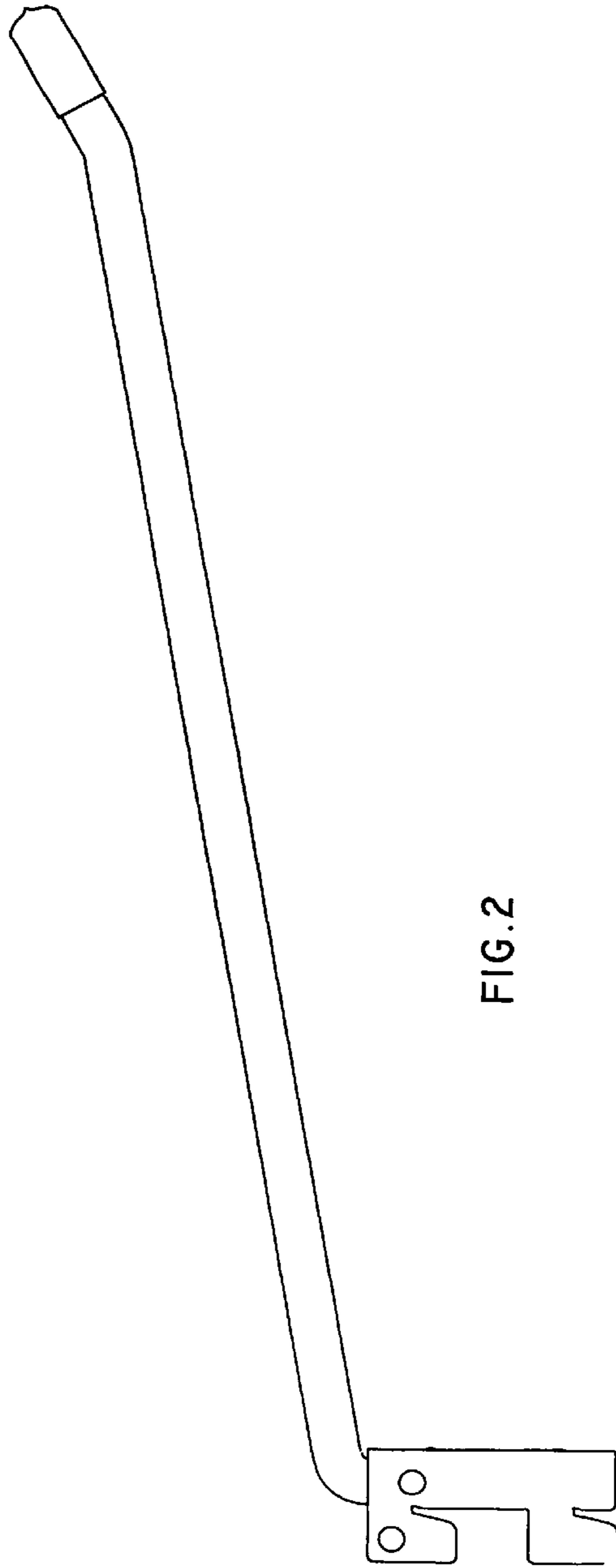

FIG. 2

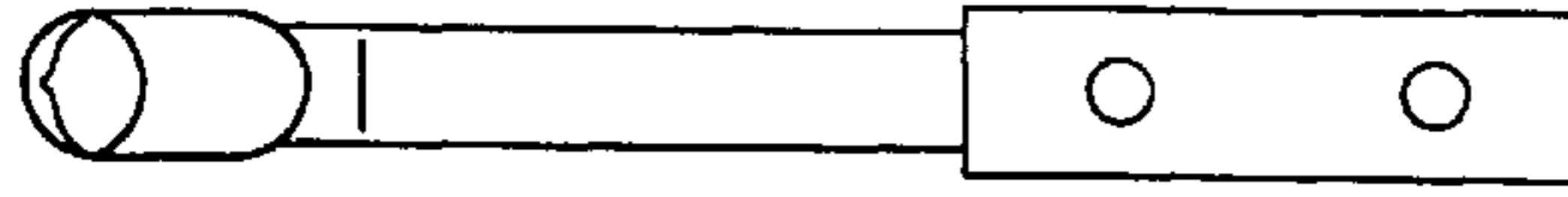

FIG. 5

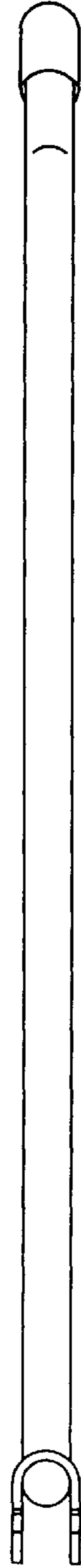

FIG. 4

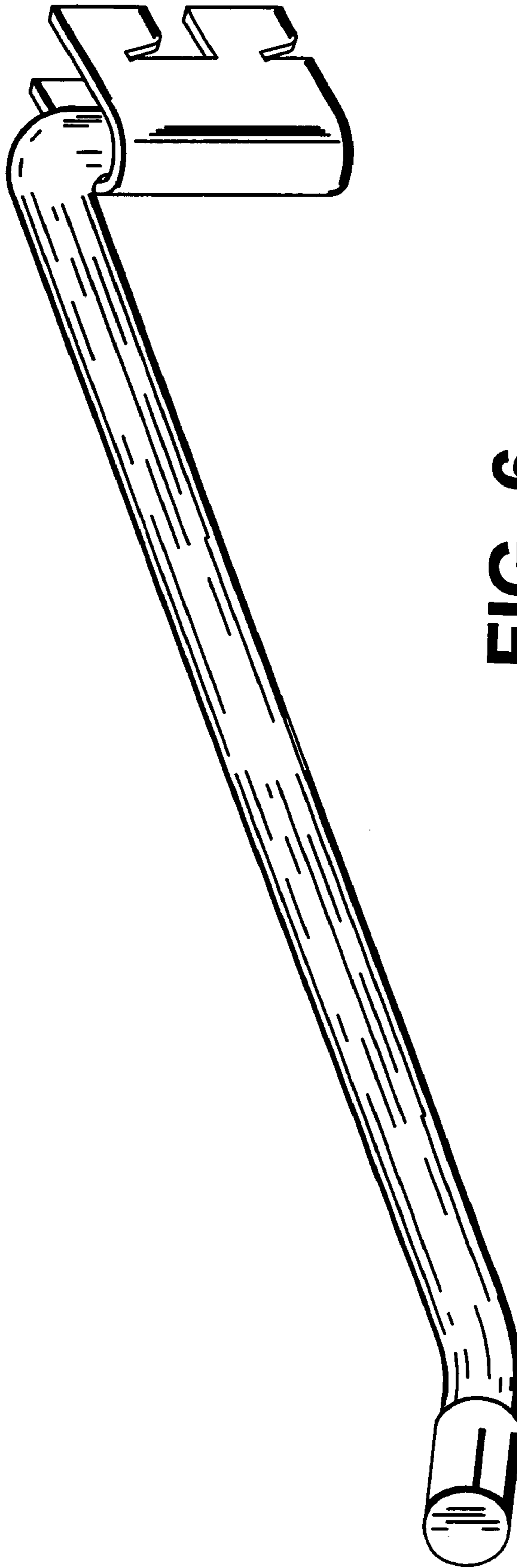

FIG. 6

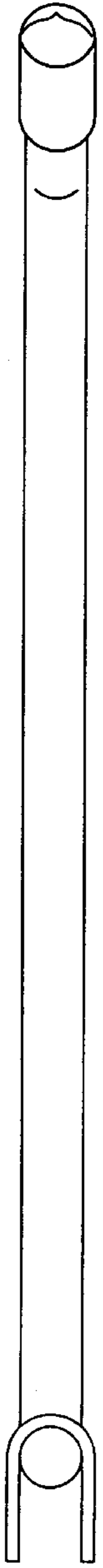

FIG. 8

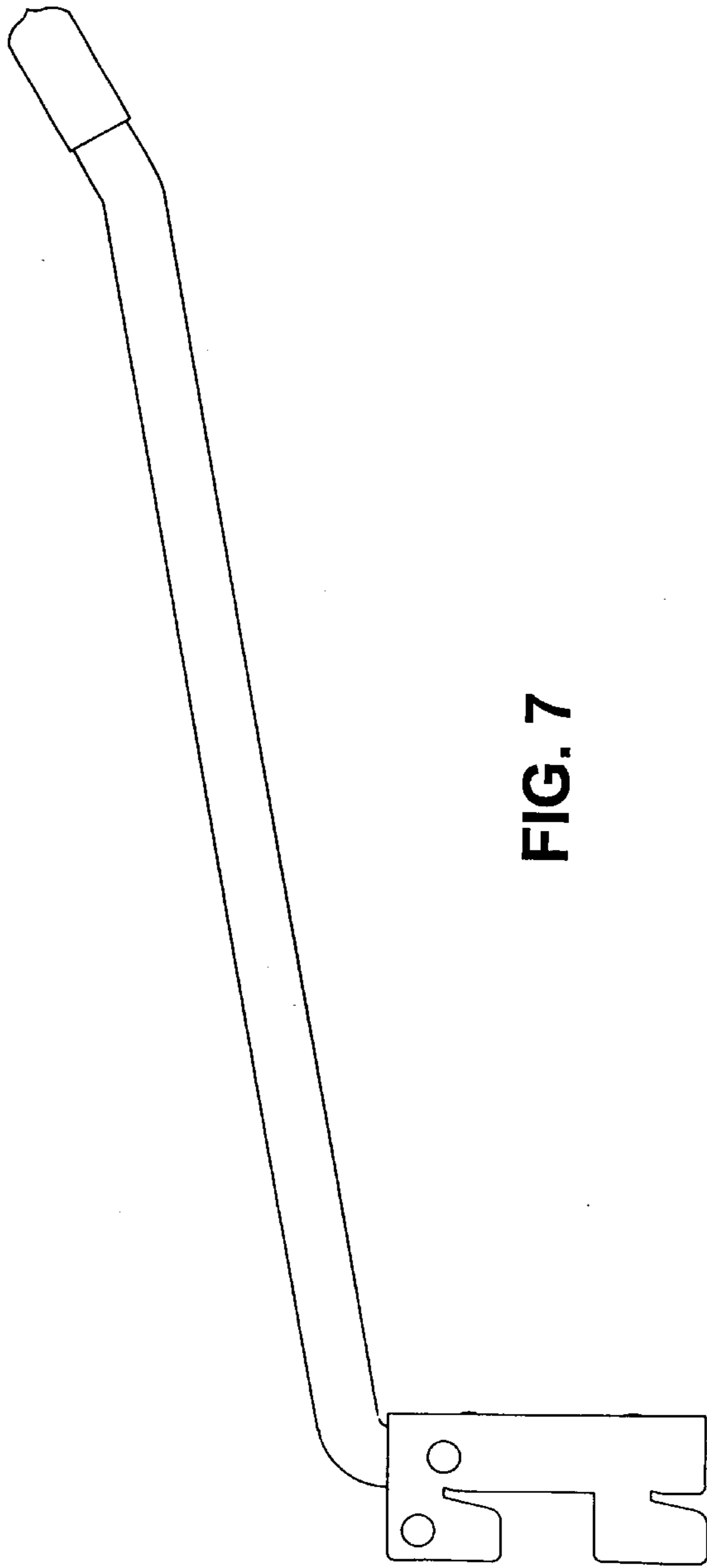

FIG. 7

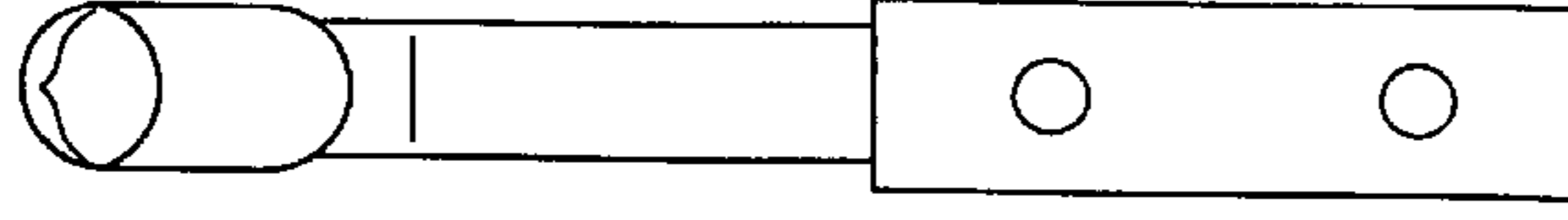

FIG. 10



FIG. 9

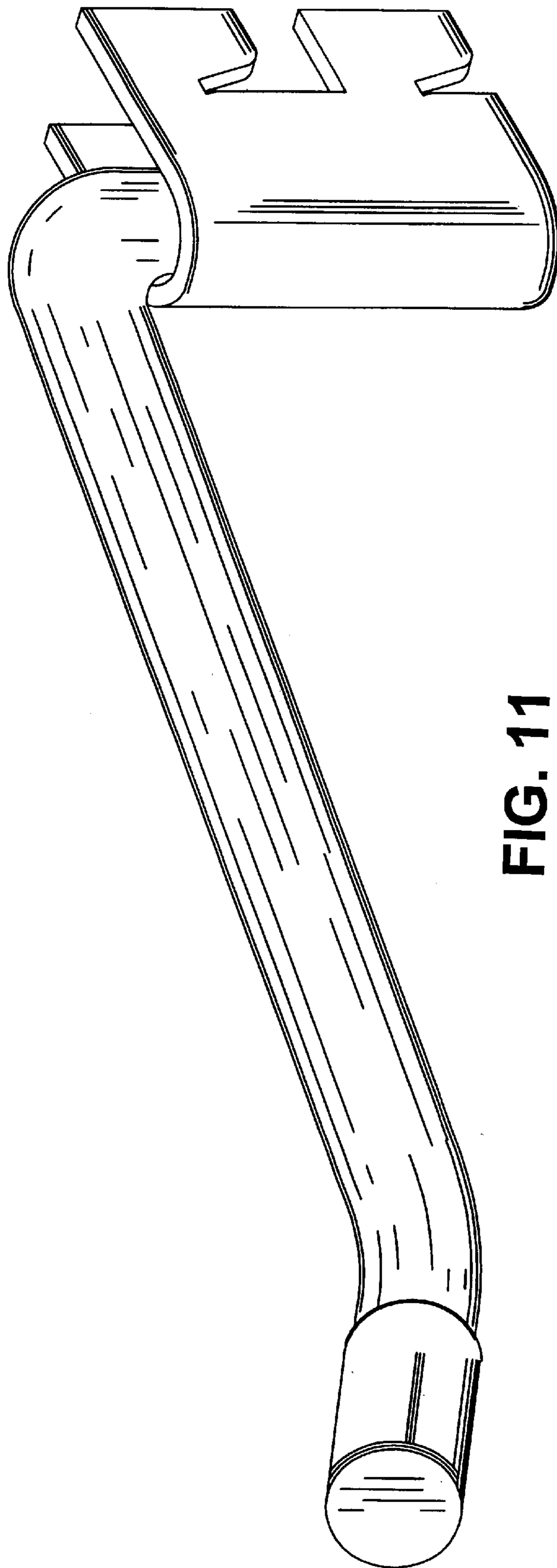

FIG. 11

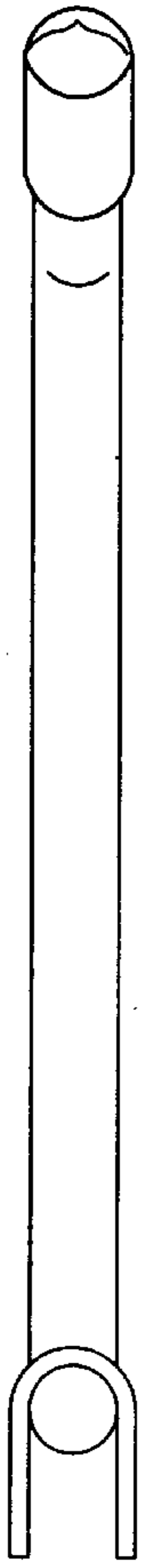

FIG. 13

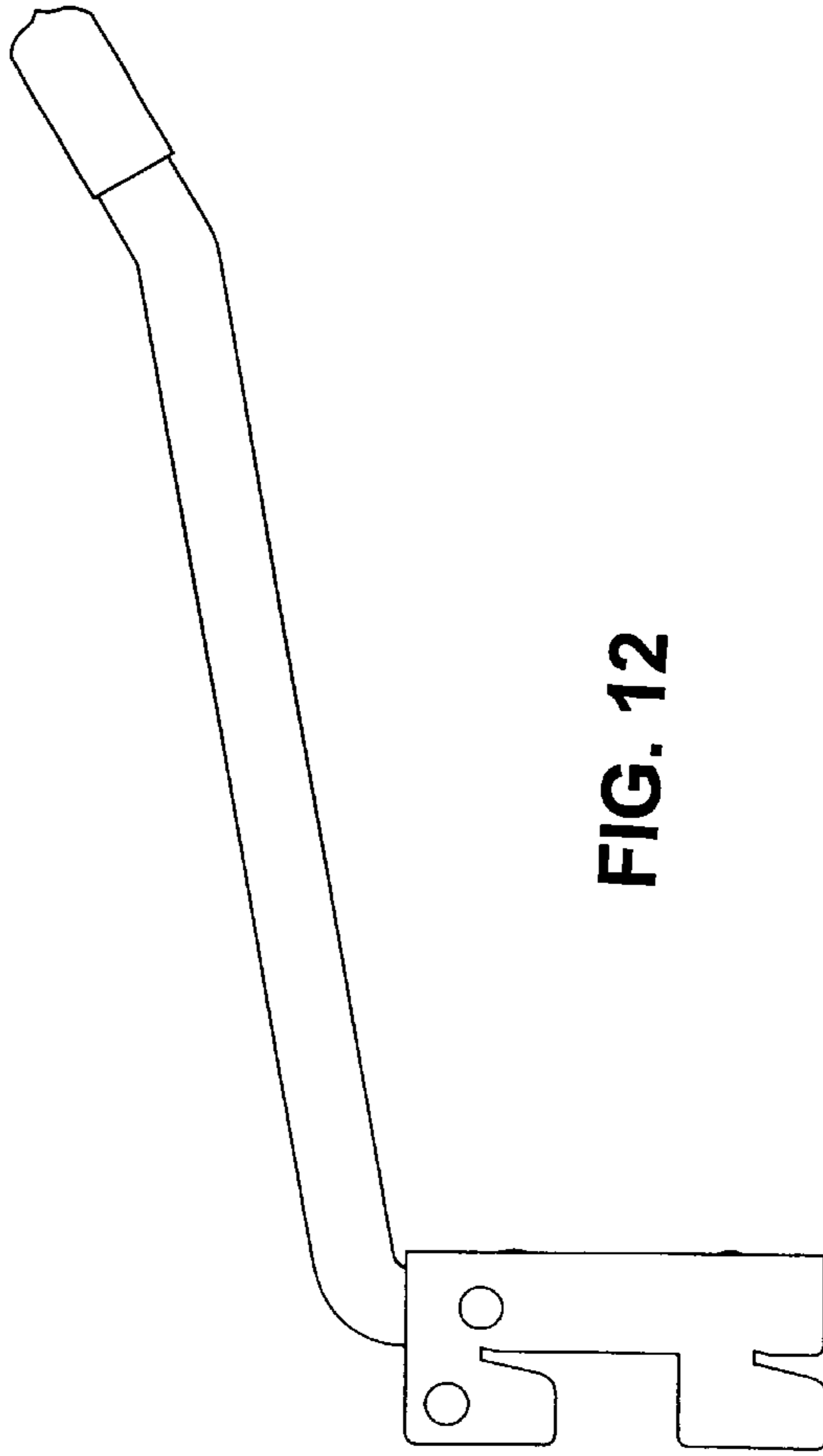

FIG. 12

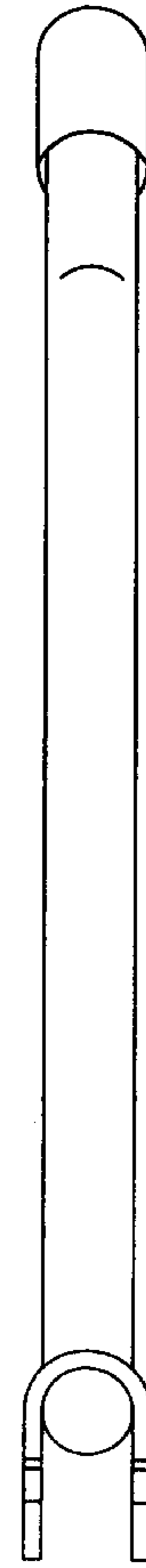

FIG. 14

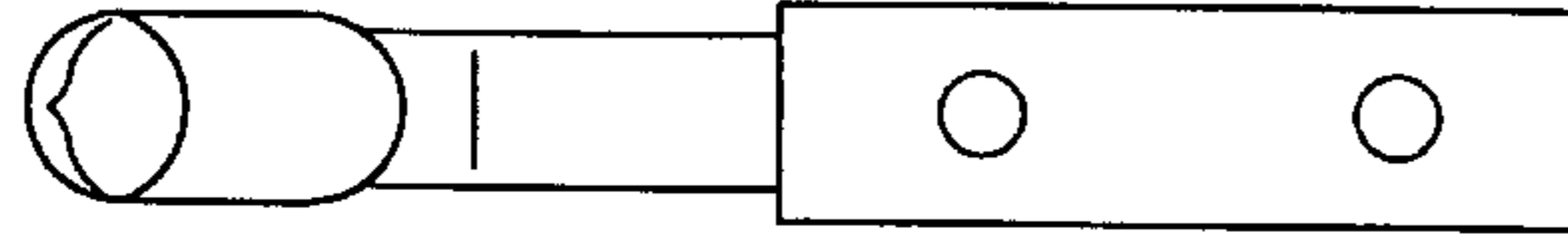

FIG. 15