



US00D446365S

(12) **United States Design Patent** (10) **Patent No.:** **US D446,365 S**  
**Bisson** (45) **Date of Patent:** **\*\* Aug. 7, 2001**

(54) **CLEANING DEVICE**

(76) Inventor: **Montgomery Bisson**, 4902 Searidge Cir., Huntington Beach, CA (US) 92649

(\*\*) Term: **14 Years**

(21) Appl. No.: **29/130,125**

(22) Filed: **Sep. 27, 2000**

(51) **LOC (7) Cl.** ..... **15-05**

(52) **U.S. Cl.** ..... **D32/21**

(58) **Field of Search** ..... D32/21, 23-25, D32/31, 17-18; 15/344, 327.5, 329, 412

(56) **References Cited**

**U.S. PATENT DOCUMENTS**

D. 204,332	*	4/1966	Hargraves	.....	D32/31
D. 204,366	*	4/1966	Nelson	.....	D32/31
D. 219,835	*	2/1971	Otto et al.	.....	D32/31
D. 312,517		11/1990	Hohrein, II et al.	.	
D. 326,747	*	6/1992	Stickle	.....	D32/21
D. 344,632	*	3/1994	Owens	.....	D4/115
D. 398,426	*	9/1998	Bisson	.....	D32/21
2,595,752	*	5/1952	Batts	.....	248/224.8
4,325,162	*	4/1982	Chambers et al.	.....	15/327.5
5,267,371	*	12/1993	Soler et al.	.....	15/327.5
6,073,301	*	6/2000	Berfield	.....	15/327.5

**OTHER PUBLICATIONS**

Castex Industries, Inc., assorted catalog sheets (3 pp.), dated on or about Apr. 21, 1999, Holland, Michigan.

Castex Industries, Inc., *Portapac Reference Manual*, dated on or about Apr. 21, 1999, pp. 1 and 3, Holland, Michigan.

Cyberspace Vacuum cleaner Museum Web Page, *Universal Tank Cleaner*, Apr. 22, 1999, 2 pp., <http://www.137.com/museum/universa.htm>.

Metropolitan Vacuum Cleaner Co., Inc., advertisement for Omnivac, *Floor Care Professional*, Jan., 1999. pg. 41.

Miracle Marketing Corp., sales pamphlet for Lil' Hummer, dated on or about Apr. 21, 1999, 2 pp., Salt Lake City, Utah.

Miracle Marketing Corp., sales pamphlet for Optimus 1, dated on or about Apr. 21, 1999, 2 pp., Salt Lake City, Utah.

National Super Service Company, sales pamphlet for Outlaw B/V, dated on or about Apr. 21, 1999, 2 pp., Toledo Ohio.

North American Cleaning Equipment, advertisement for RSV 100 Hip Hugger™, *Maintenance Supplies*, May, 1998, pg. 49.

Pacific Steamex, sales pamphlet for Pacific Backpack, dated on or about Apr. 20, 1999, 2 pp., Muskegon, Michigan.

Pro-Team, sales pamphlet for Pro-Team Backpack Vacuums, dated on or about Mar. 29, 1999, 4 pp., Boise, Idaho.

Pro-Team, sheet for catalog kits, dated on or about Apr. 21, 1999, p. 4, Boise, Idaho.

*Safety, Operation and Maintenance Manual w/Parts List for Probe Backpack Vacuum™*, dated on or about Apr. 21, 1999.

Sandia Industrial Vacuums, advertisement for Raven, *Cleaning & Maintenance Management*, May, 1998, p. 48.

United Electric, sheet for catalog kits, dated on or about Apr. 21, 1999.

Windsor, advertisement for Wave™ vacuum, dated on or about Apr. 21, 1999.

\* cited by examiner

*Primary Examiner*—Ruth McInroy  
(74) *Attorney, Agent, or Firm*—Paul Adams

(57) **CLAIM**

The ornamental design for a cleaning device, as shown and described.

**DESCRIPTION**

FIG. 1 is a top plan view of a cleaning device showing my new design;

FIG. 2 is a side elevational view thereof;

FIG. 3 is a back elevational view thereof;

FIG. 4 is front elevational view thereof;

FIG. 5 is an opposite side elevational view thereof;

FIG. 6 is a bottom plan view thereof; and,

FIG. 7 is a perspective view thereof.

**1 Claim, 3 Drawing Sheets**

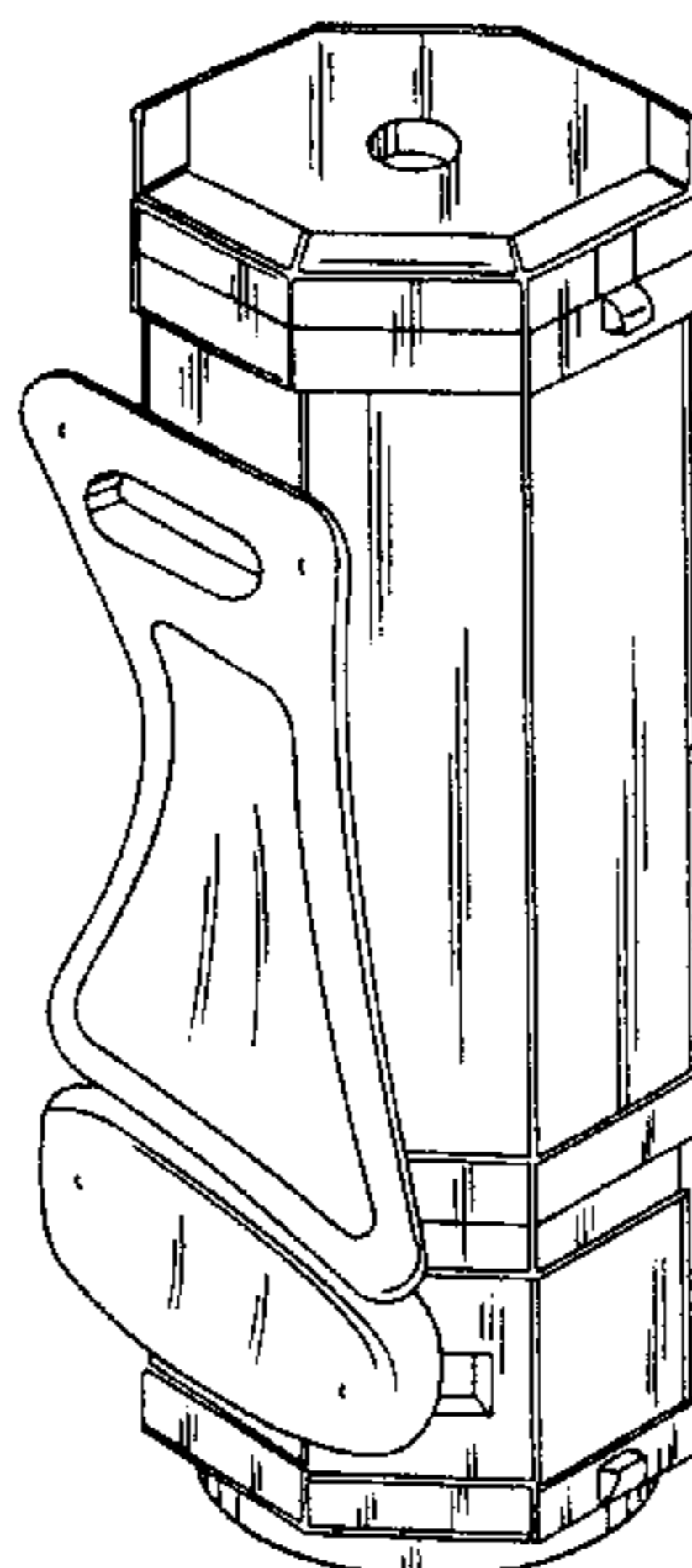

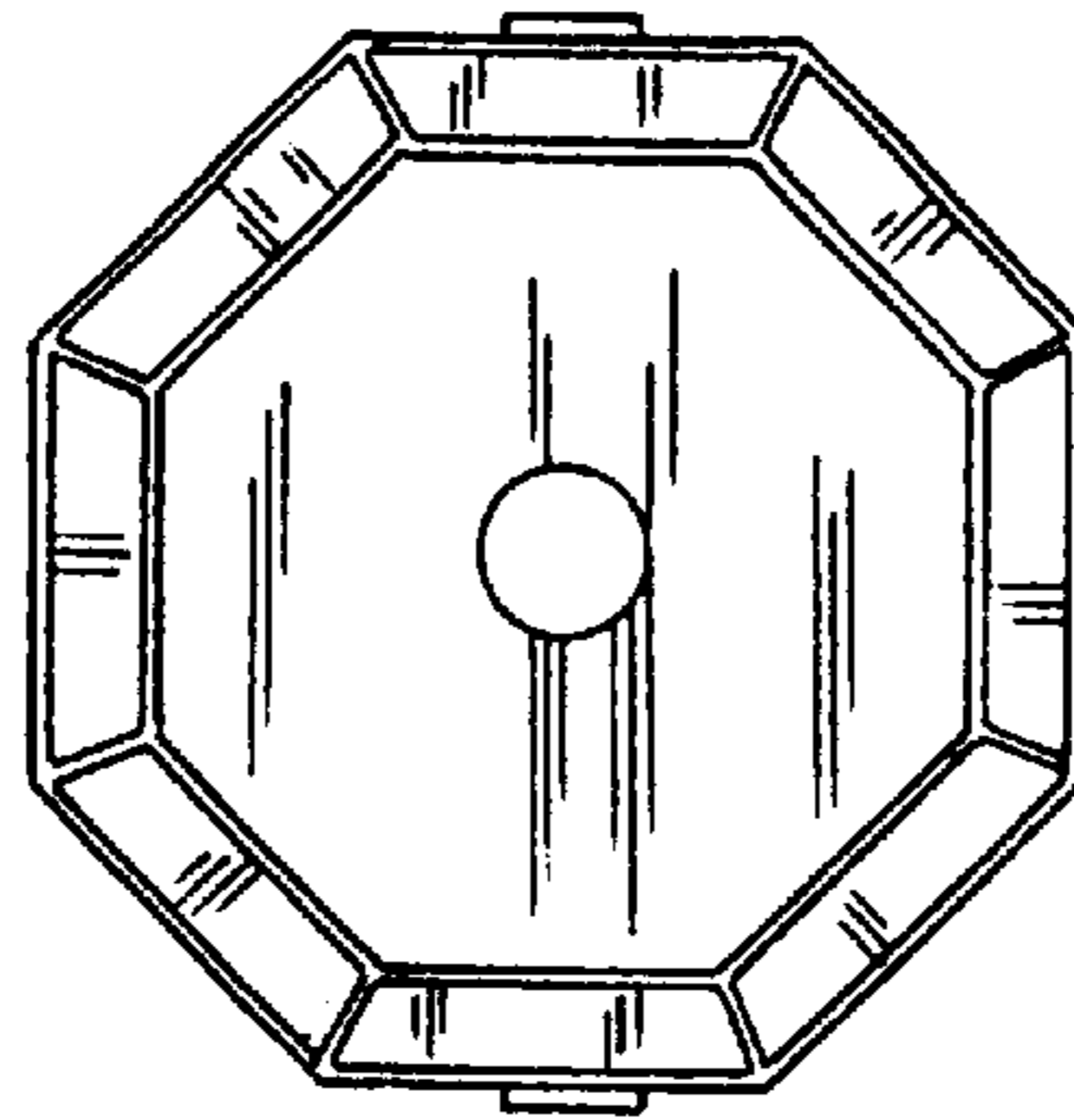

FIG-1

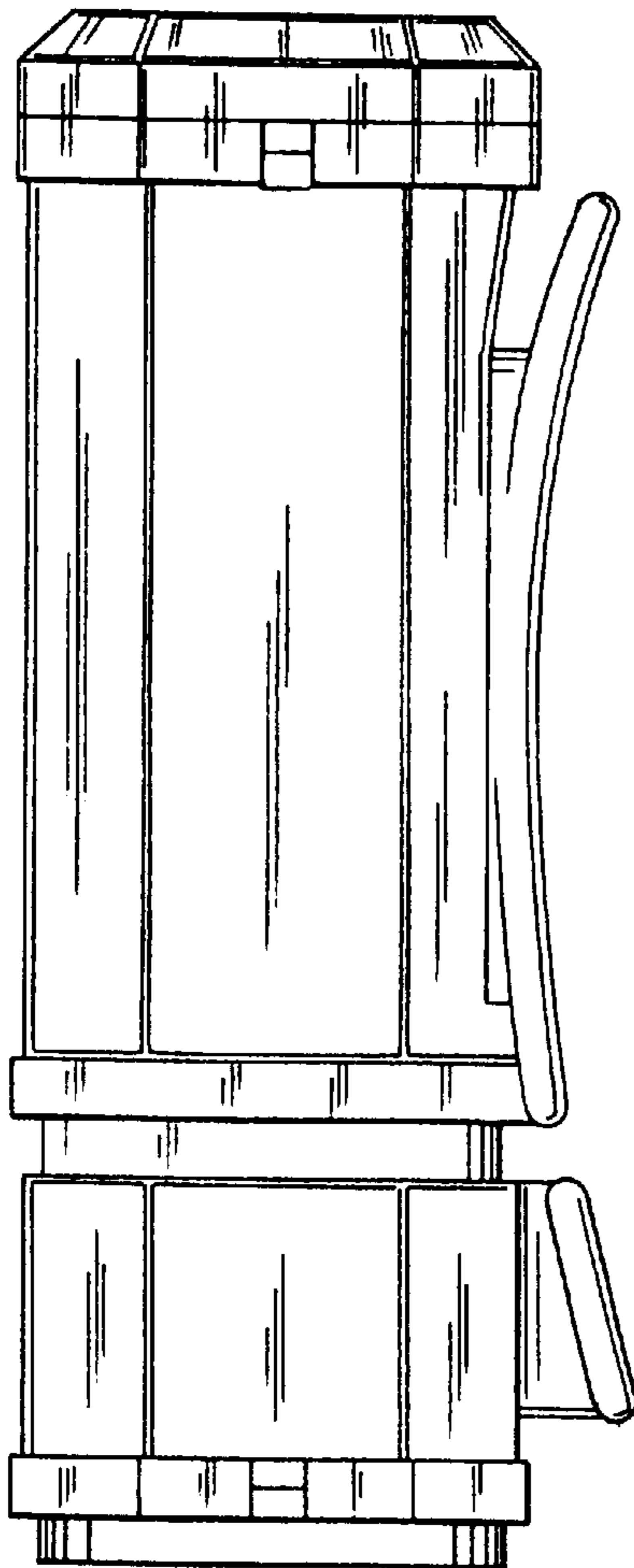

FIG-2

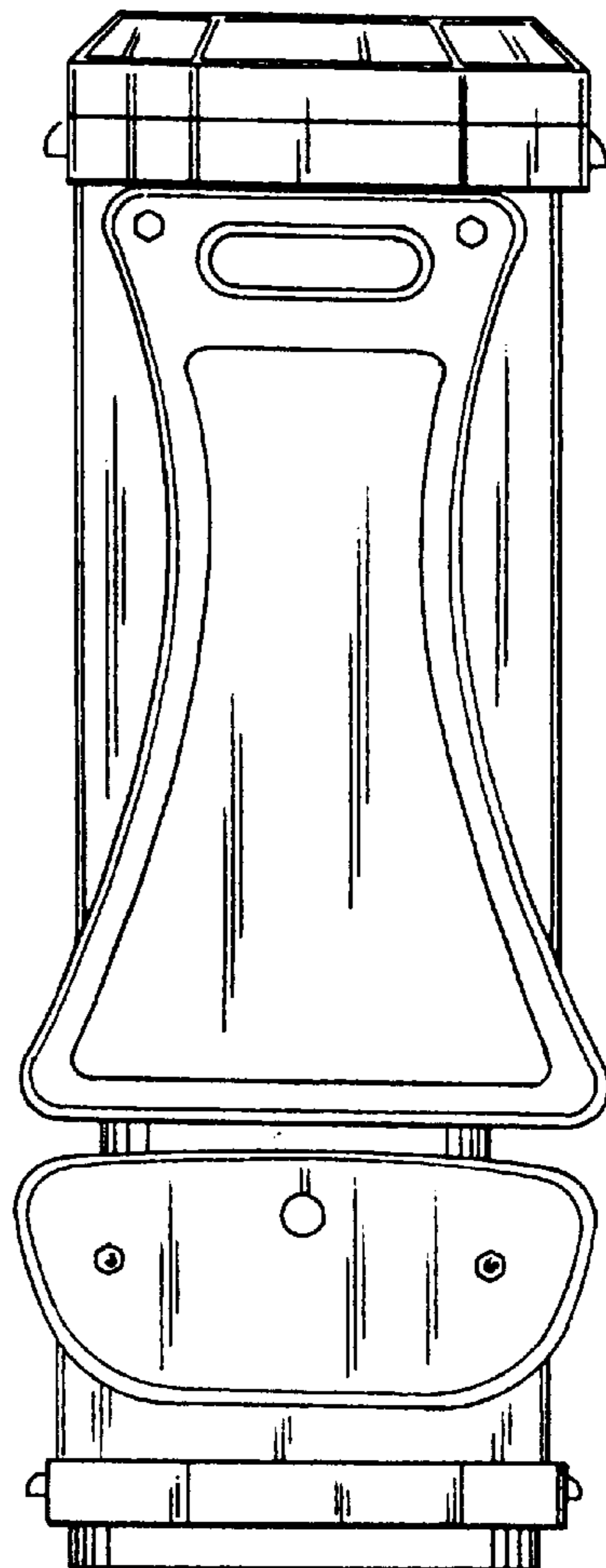

FIG-3

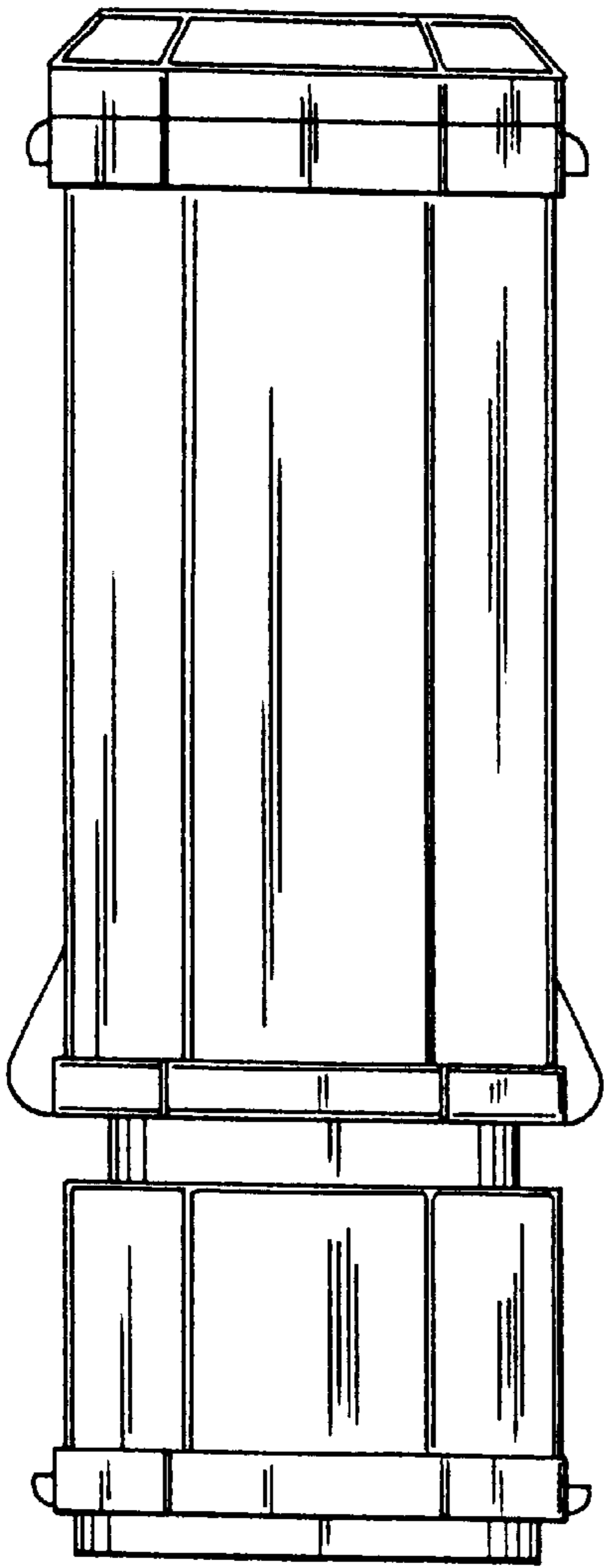

FIG-4

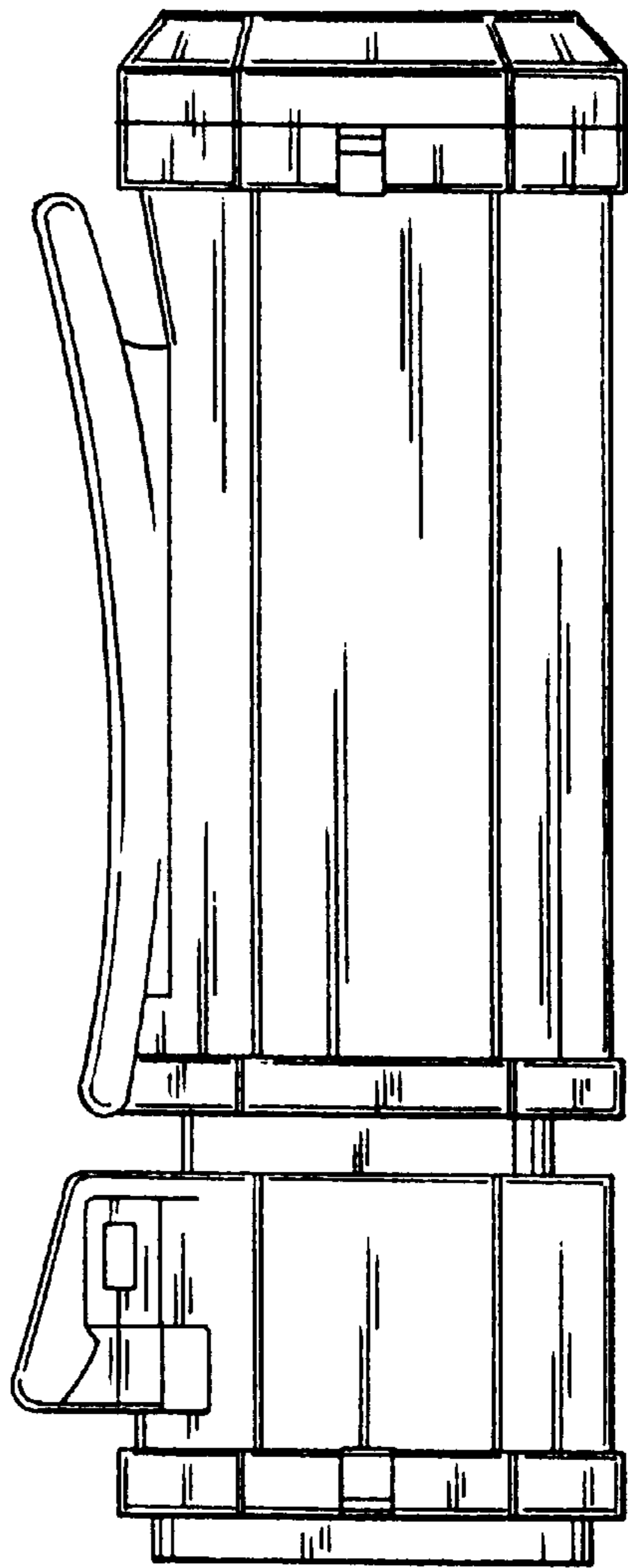

FIG-5

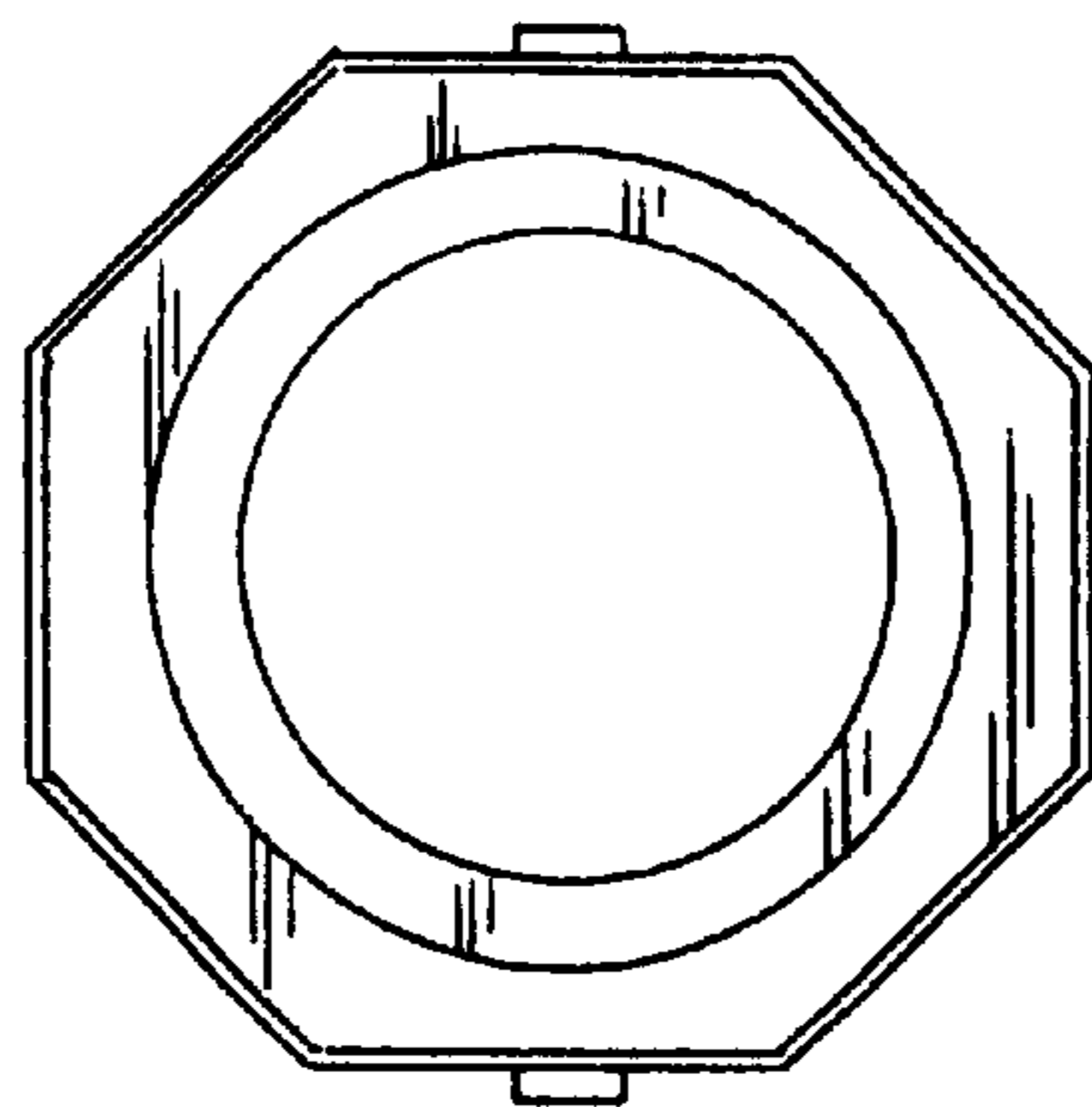

FIG-6

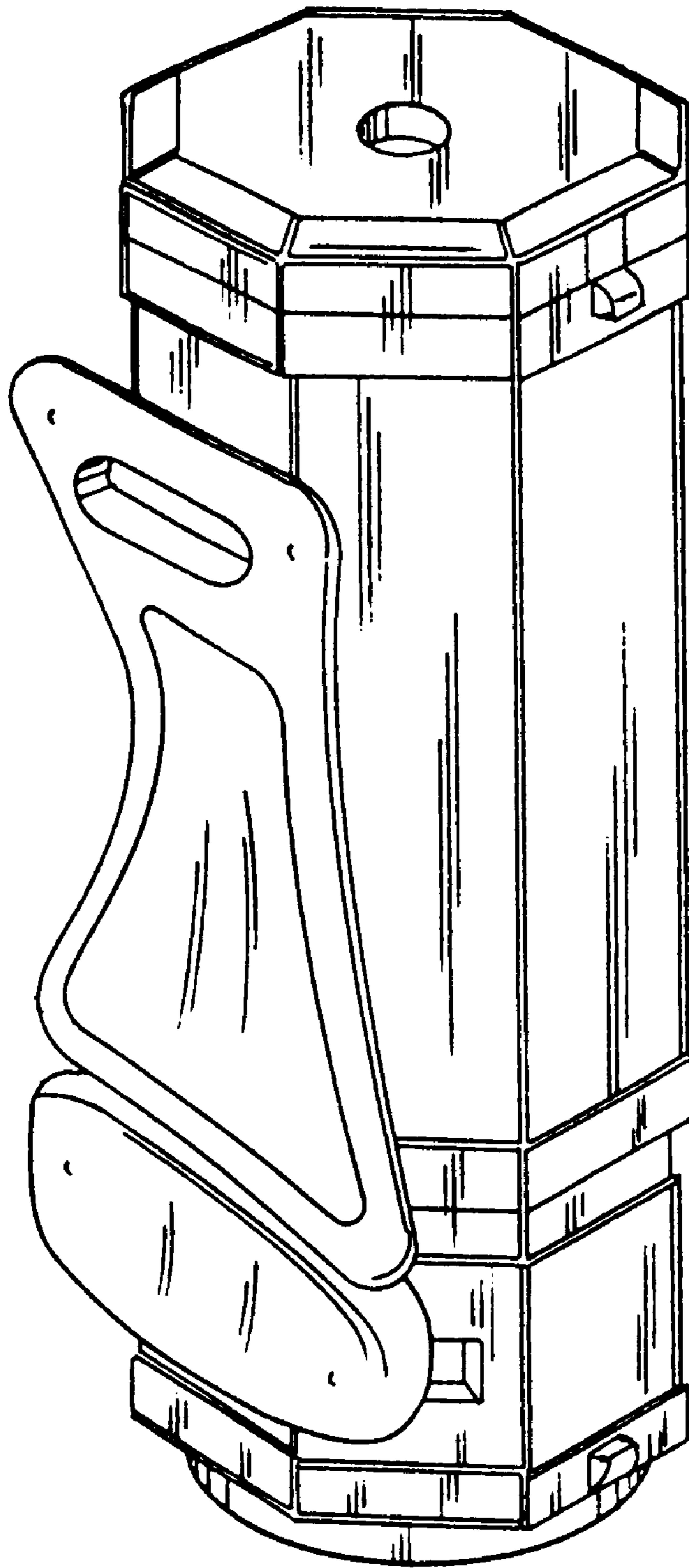

FIG-7