



US00D446255S

(12) **United States Design Patent**  
**Kupperman**

(10) **Patent No.:** **US D446,255 S**

(45) **Date of Patent:** **\*\* Aug. 7, 2001**

(54) **GAME TILE**

(75) Inventor: **Dennis Kupperman**, Glenview, IL  
(US)

(73) Assignee: **RB Toy Development Co.**, Chicago, IL  
(US)

(\*\*) Term: **14 Years**

(21) Appl. No.: **29/129,632**

(22) Filed: **Sep. 19, 2000**

(51) **LOC (7) Cl.** ..... **21-01**

(52) **U.S. Cl.** ..... **D21/391; D21/386**

(58) **Field of Search** ..... **D21/385, 386,**  
**D21/391, 396; 273/148 R, 292, 293**

(56) **References Cited**

**U.S. PATENT DOCUMENTS**

D. 238,794	*	2/1976	Smythe	.....	D21/396
303,816	*	8/1884	Crosby	.....	273/293
4,239,231	*	12/1980	Henderson	.....	273/293
4,461,483	*	7/1984	Kopp	.....	273/265
5,662,332	*	9/1997	Garfield	.....	273/308

\* cited by examiner

*Primary Examiner*—Sandra L. Morris

(74) *Attorney, Agent, or Firm*—Emrich & Dithmar

(57) **CLAIM**

The ornamental design for the game tile, as shown and described.

**DESCRIPTION**

FIG. 1 is a perspective view of a game tile incorporating the present invention;

FIG. 2 is a top plan view of the game tile illustrated in FIG. 1;

FIG. 3 is a bottom plan view of the game tile illustrated in FIG. 1;

FIG. 4 is a front view of the game tile illustrated in FIG. 1;

FIG. 5 is a rear view of the game tile illustrated in FIG. 1;

FIG. 6 is an end view of the game tile illustrated in FIG. 1;

FIG. 7 is a perspective view like FIG. 1 of the bottom of the game tile illustrated in FIG. 1;

FIG. 8 are two tiles mated;

FIG. 9 is a top plan view of the two mated tiles illustrated in FIG. 8;

FIG. 10 is a bottom plan view of the tiles mated in FIG. 8;

FIG. 11 is a front view of the game tile in FIG. 8;

FIG. 12 is a rear view of the game tile in FIG. 8;

FIG. 13 is a end view of the game tile in FIG. 8; and,

FIG. 14 is a bottom perspective view of the game tile illustrated in FIG. 8.

**1 Claim, 2 Drawing Sheets**

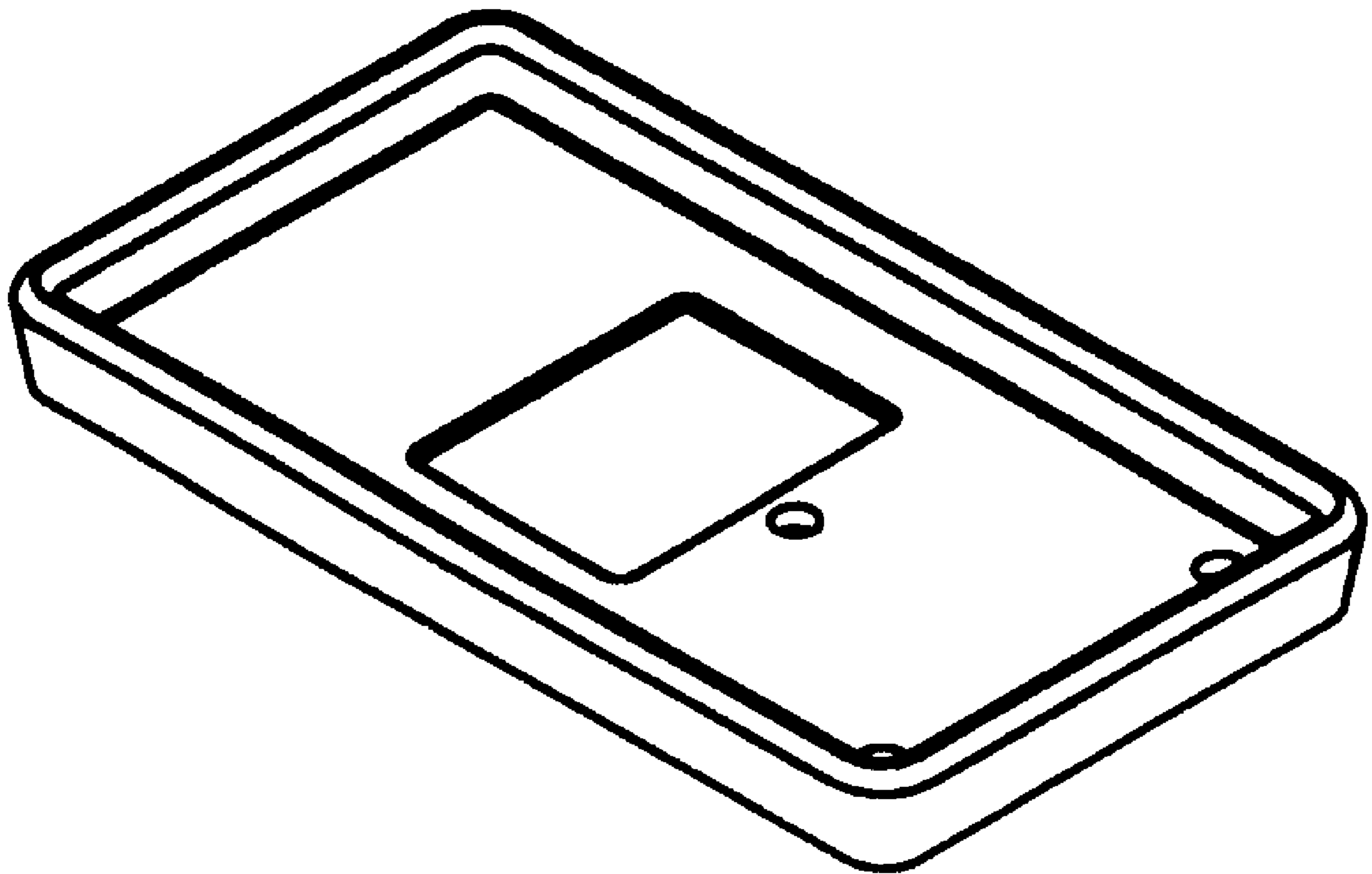

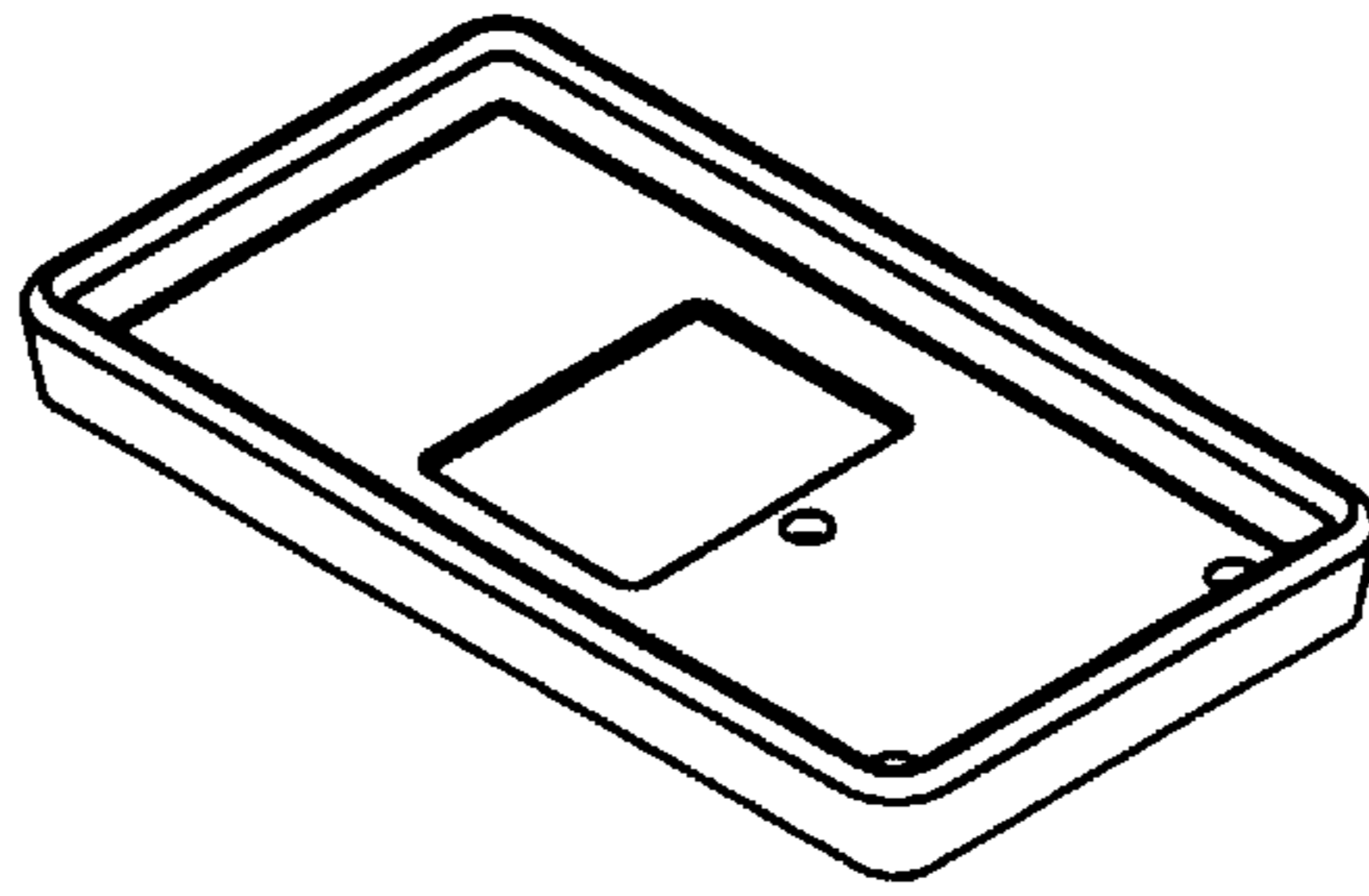

FIG. 1

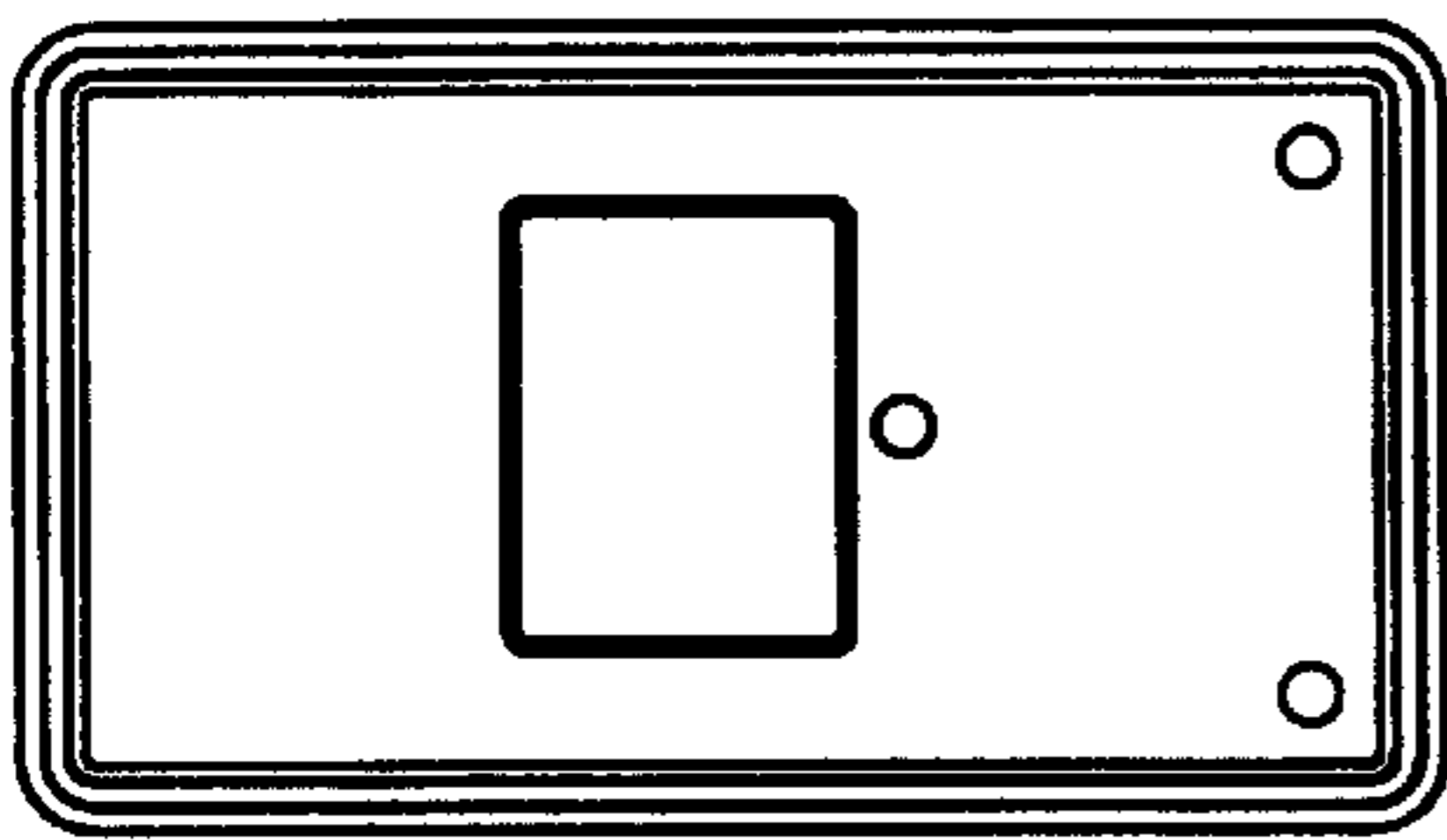

FIG. 2

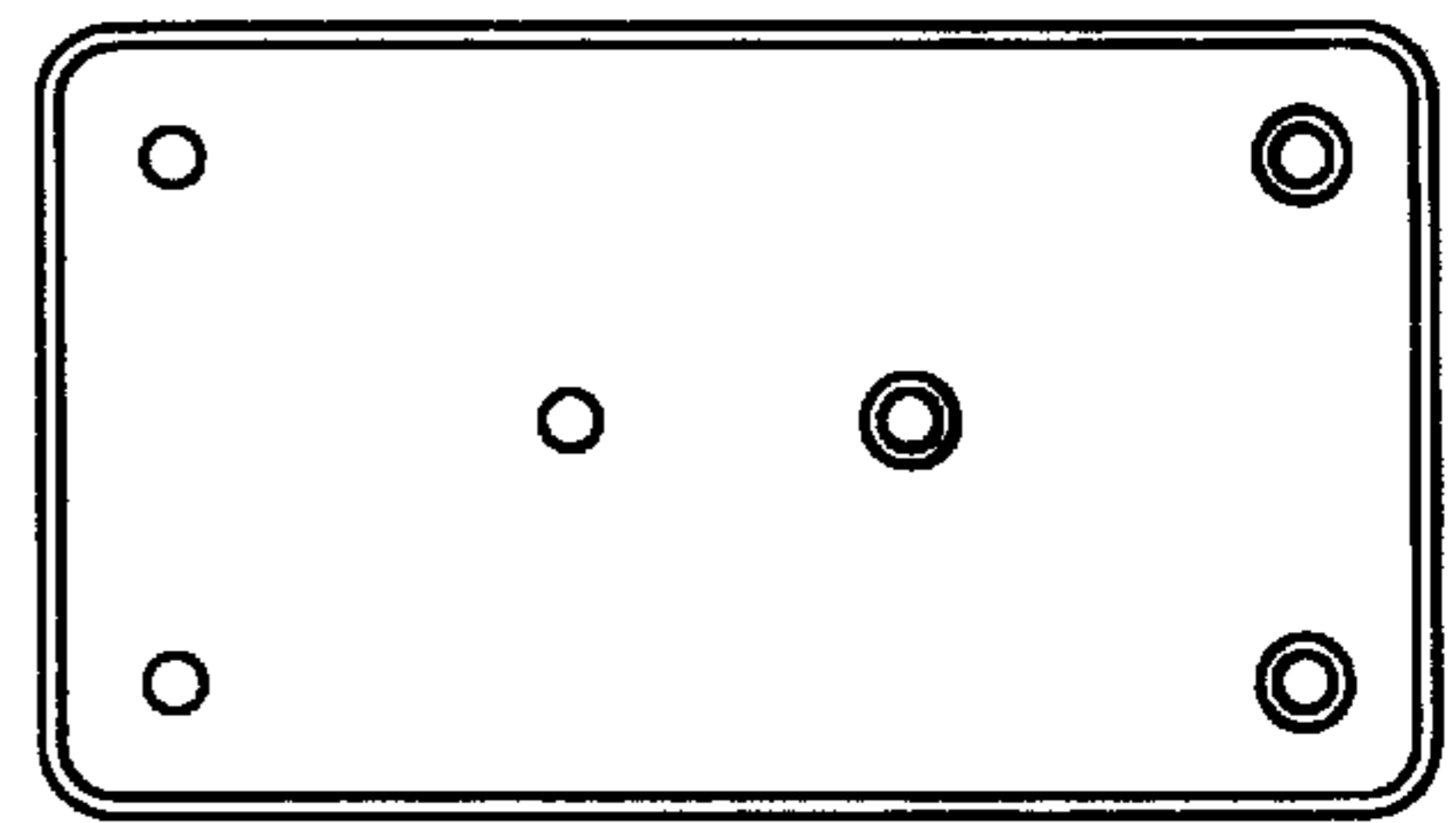

FIG. 3

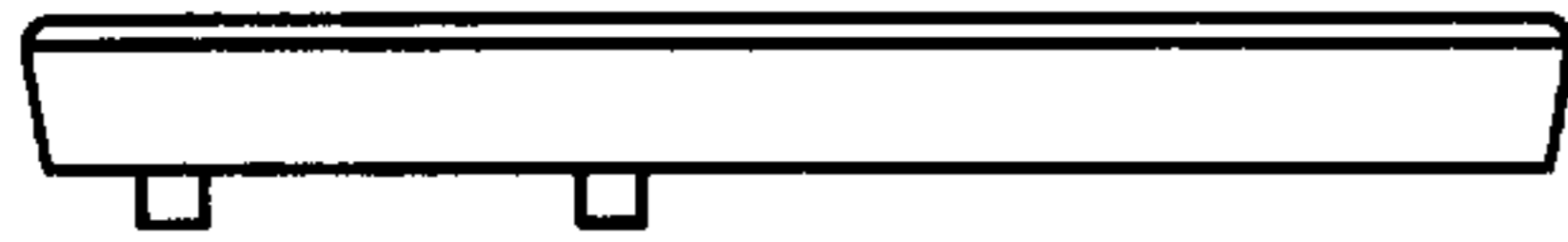

FIG. 4

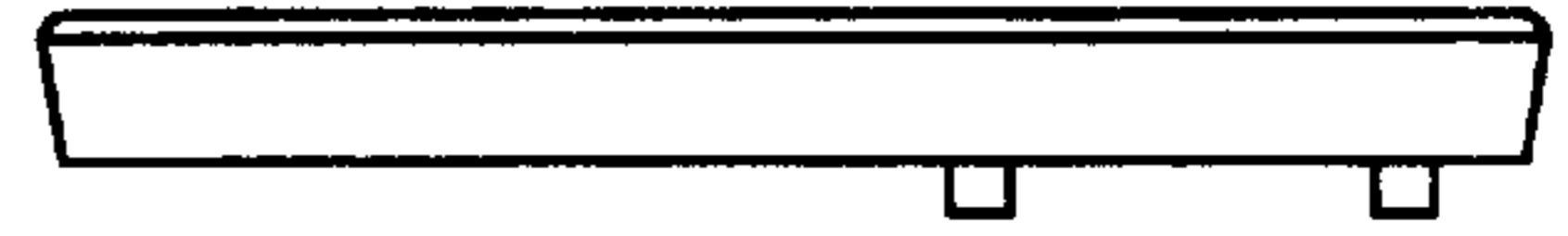

FIG. 5

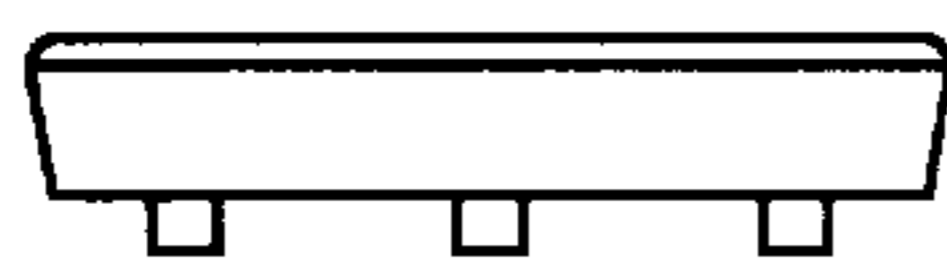

FIG. 6

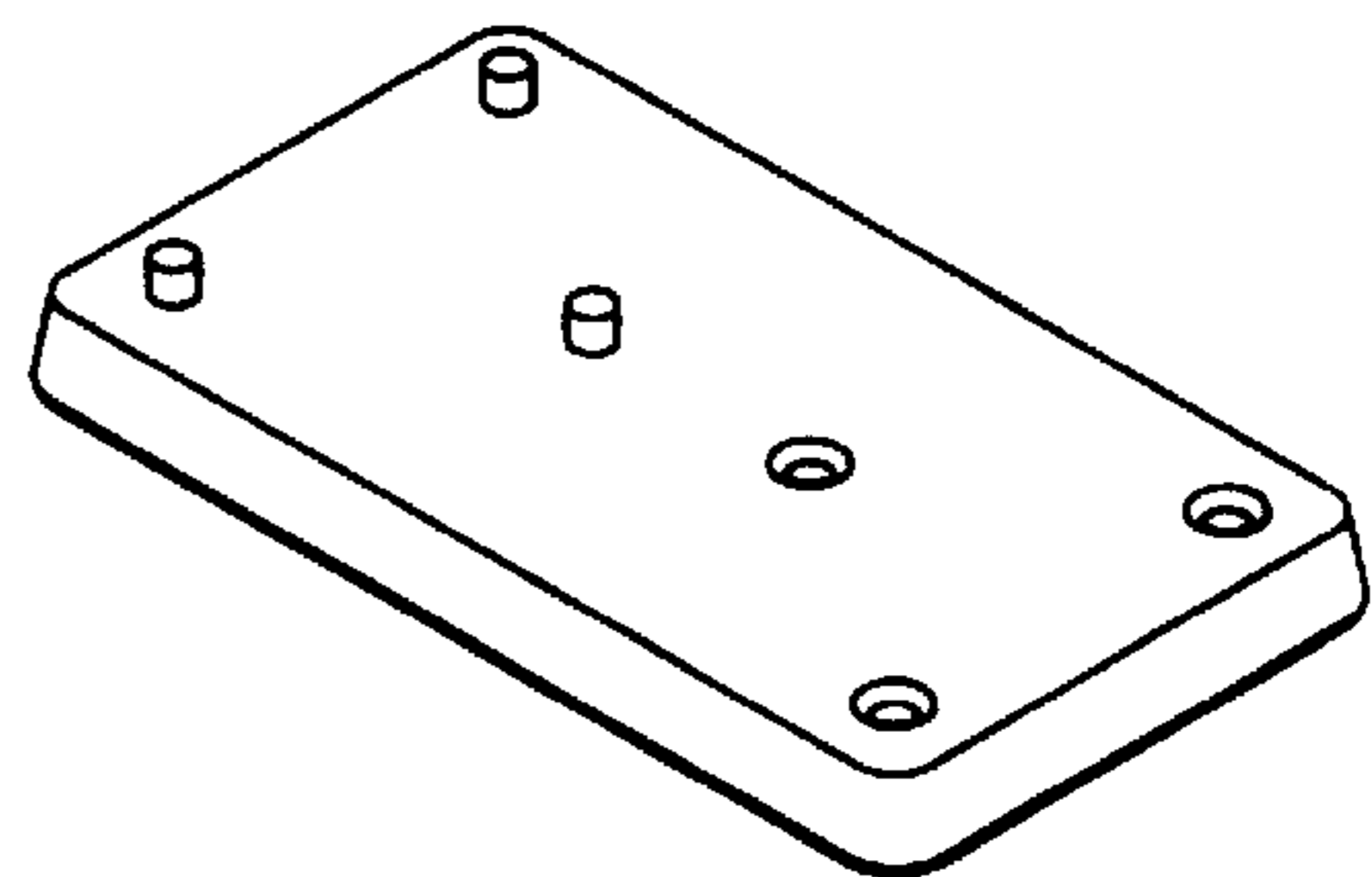

FIG. 7

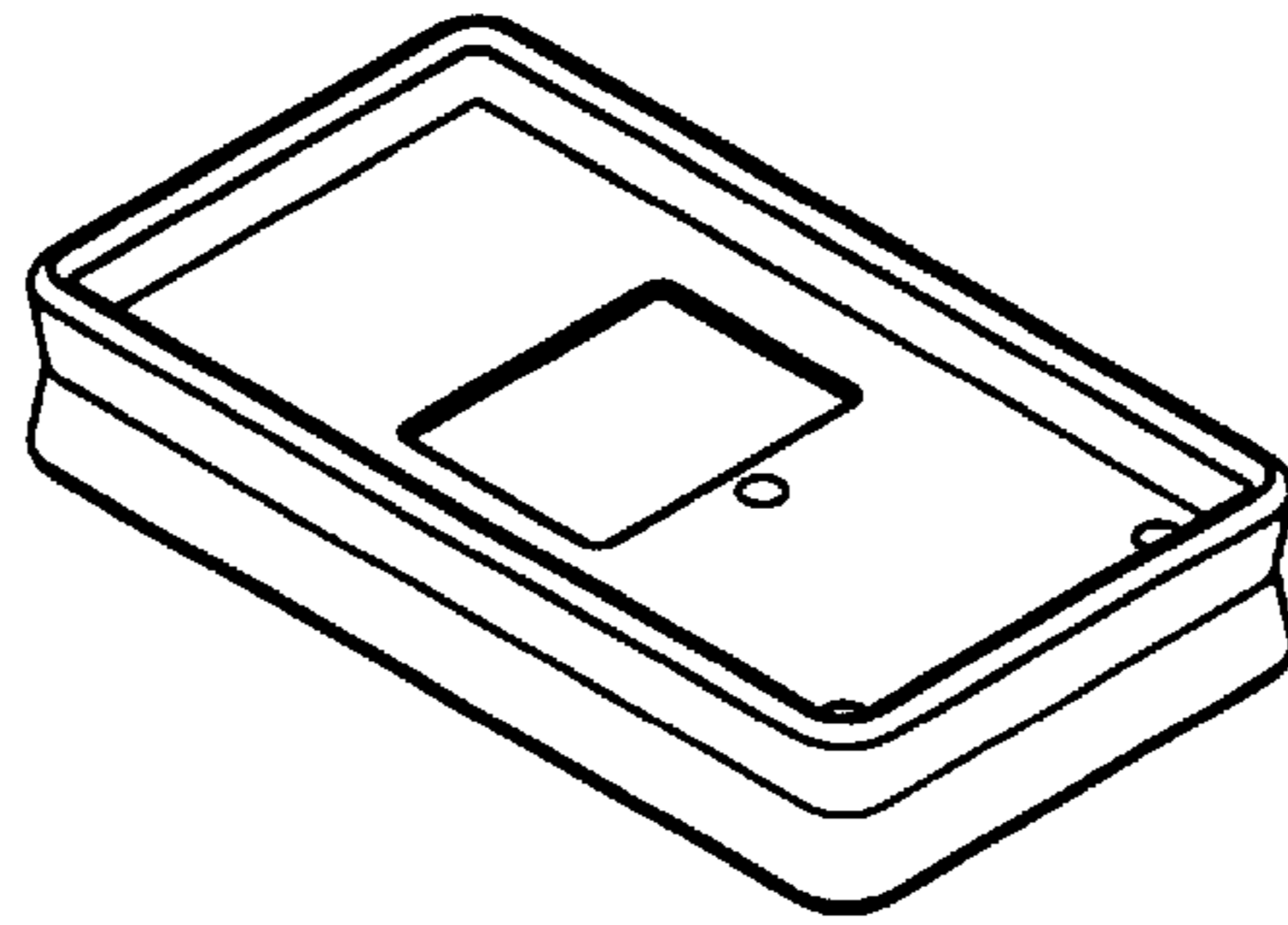

FIG. 8

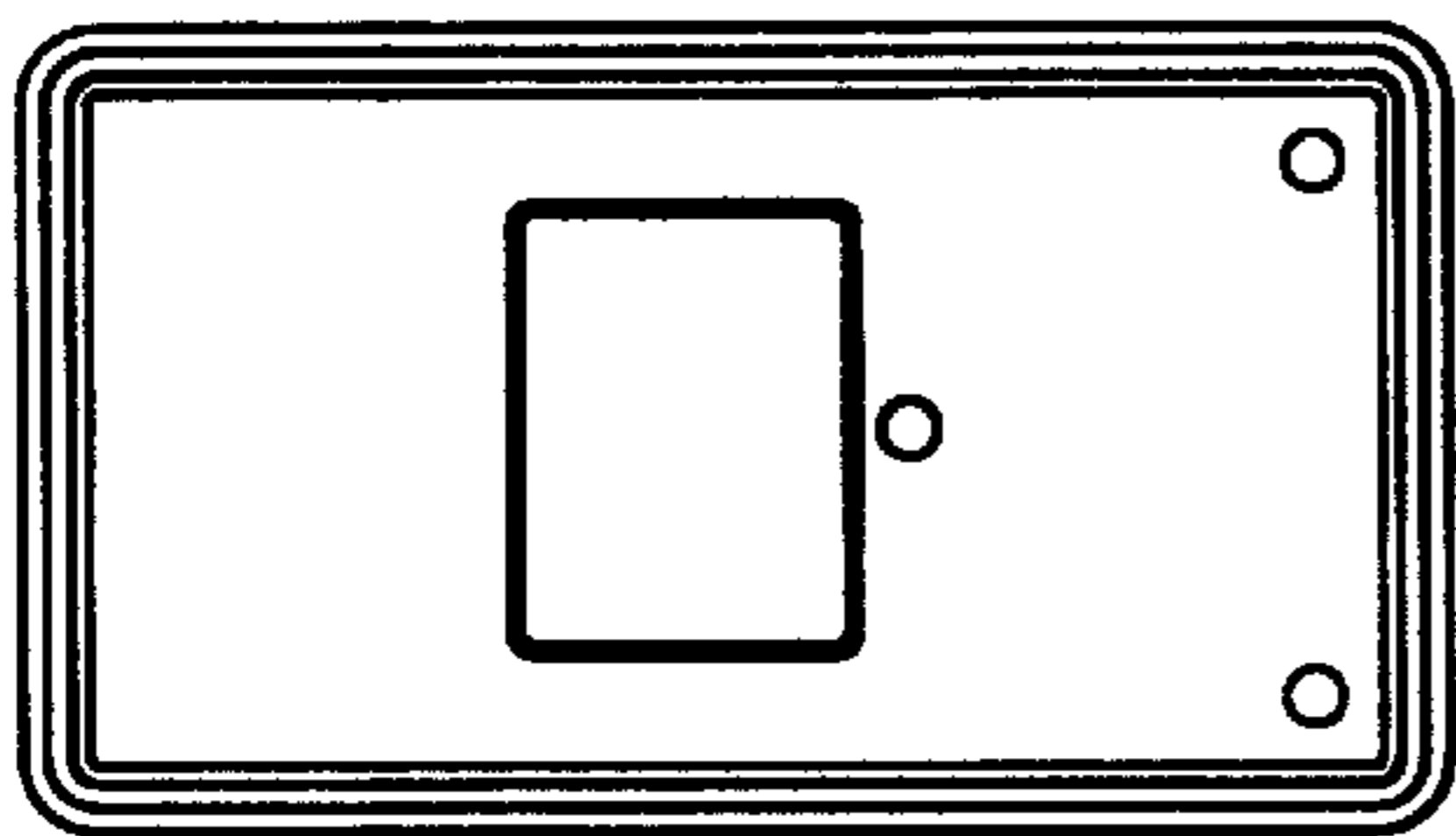

FIG. 9

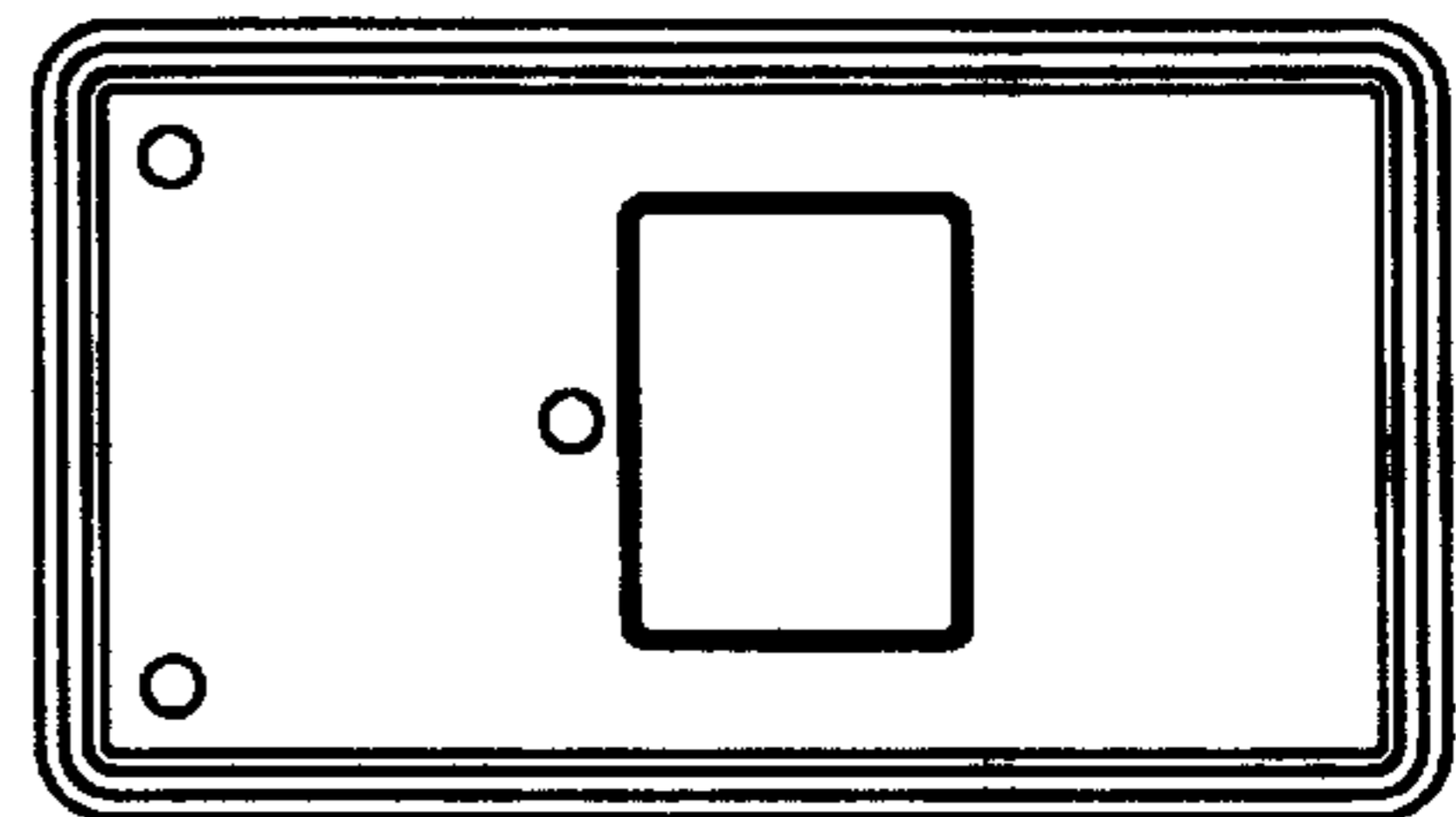

FIG. 10

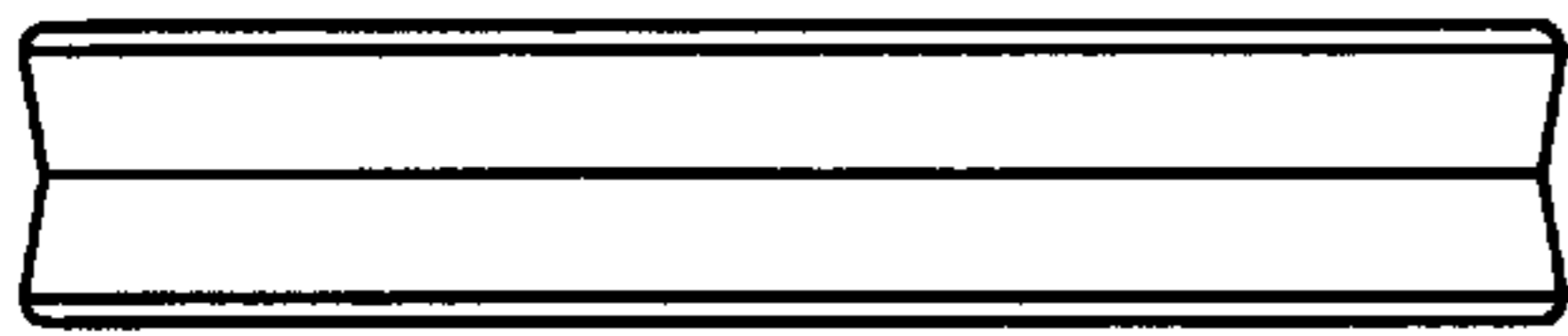

FIG. 11

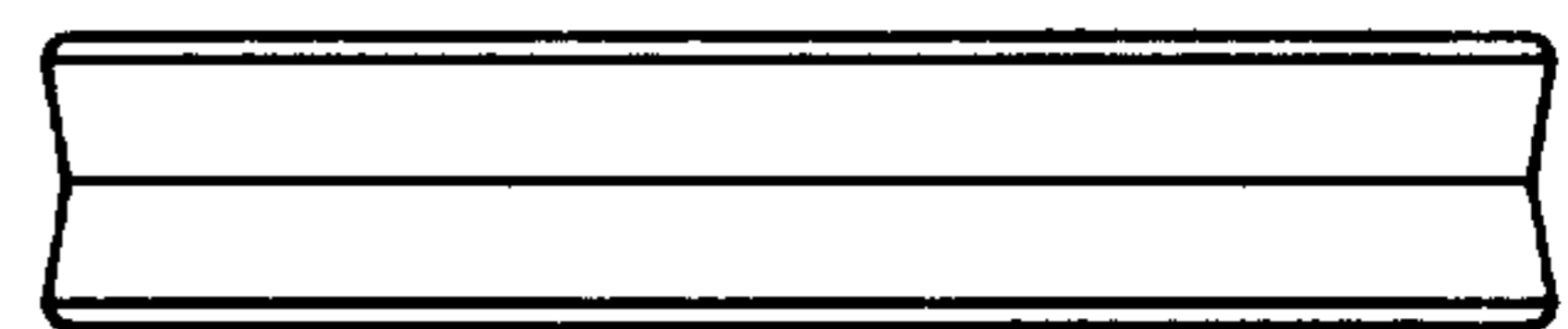

FIG. 12

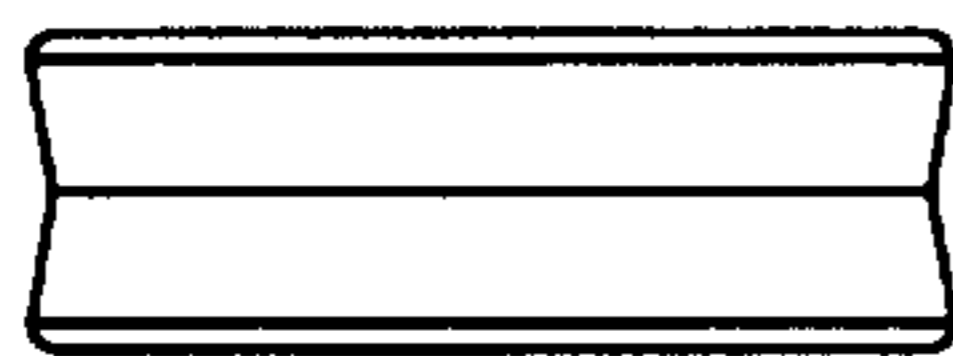

FIG. 13

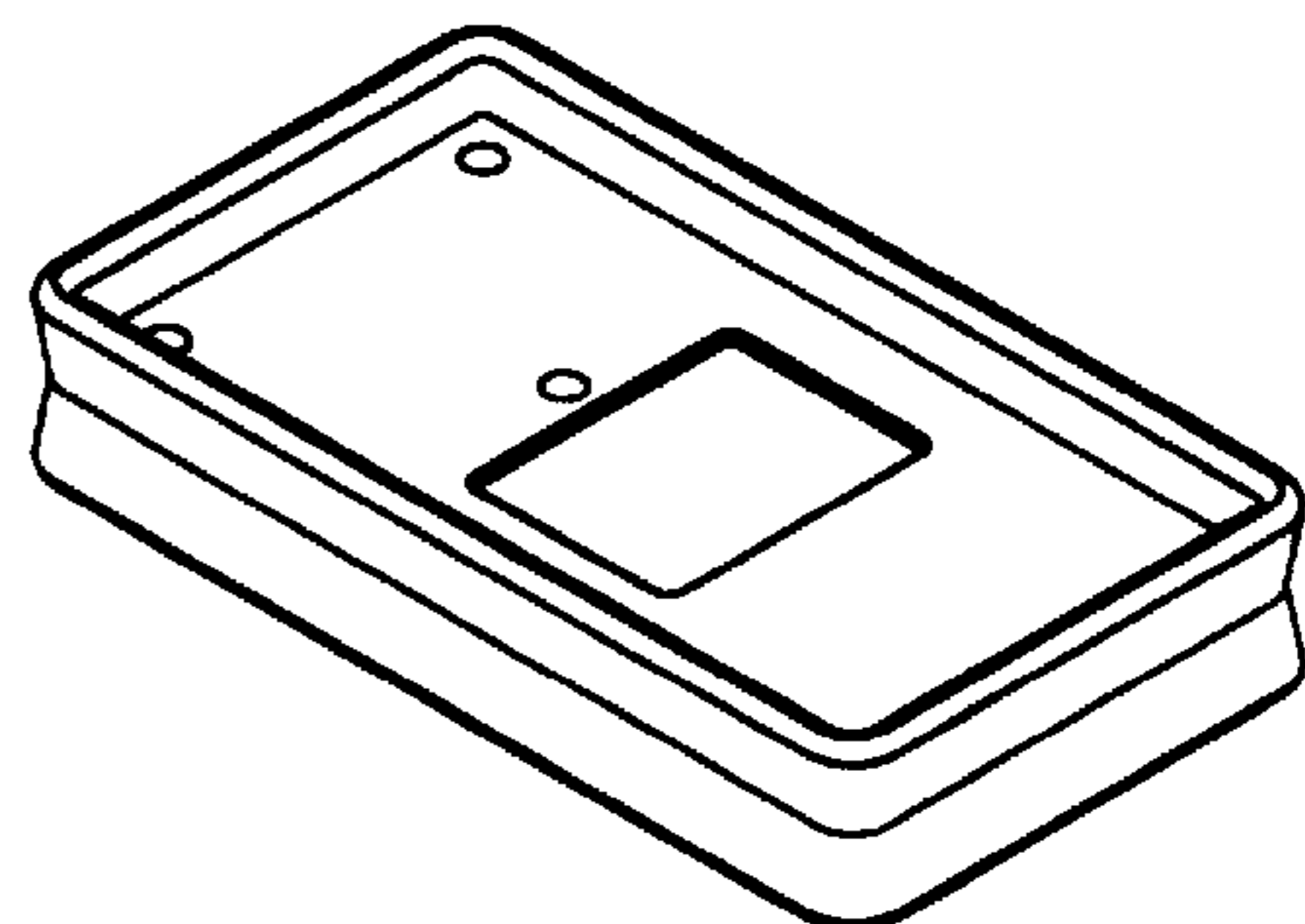

FIG. 14