



US00D446242S

(12) **United States Design Patent**
Stukenkemper

(10) **Patent No.:** **US D446,242 S**

(45) **Date of Patent:** **** Aug. 7, 2001**

(54) **WRITING INSTRUMENT**

(75) **Inventor:** **Heinrich Stukenkemper,**
Castrop-Rauxel (DE)

(73) **Assignee:** **Sanford GmbH, Hamburg (DE)**

(**) **Term:** **14 Years**

(21) **Appl. No.:** **29/126,866**

(22) **Filed:** **Jul. 25, 2000**

(30) **Foreign Application Priority Data**

Feb. 22, 2000 (DE) 4 00 02 006

(51) **LOC (7) Cl.** **19-06**

(52) **U.S. Cl.** **D19/43; D19/47; D19/48;**
D19/56; D19/57

(58) **Field of Search** D19/35, 36, 41-51,
D19/53-58, 81-85; 401/98, 202, 209, 243-247,
262, 6, 7; 24/10 R, 11 R, 11 CT, 11 C,
11 PP

(56) **References Cited**

U.S. PATENT DOCUMENTS

- D. 141,630 * 6/1945 Chapman D19/47
- D. 147,107 * 7/1947 Breitenstein D19/48
- D. 161,426 * 1/1951 Covey et al. D19/48

- D. 286,547 * 11/1986 Koizumi et al. D19/51
- D. 294,281 * 2/1988 Song D19/47
- D. 414,202 * 9/1999 Beneyto D19/47
- D. 426,573 * 6/2000 Sekine et al. D19/48
- D. 428,917 * 8/2000 Gruosi D19/48

* cited by examiner

Primary Examiner—Martie K. Holtje

(74) *Attorney, Agent, or Firm*—Marshall, O'Toole,
Gerstein, Murray & Borun

(57) **CLAIM**

The ornamental design for a writing instrument, as shown and described.

DESCRIPTION

FIG. 1 is a perspective view showing my new design;
 FIG. 2 is a front elevational view thereof;
 FIG. 3 is a left elevational view thereof;
 FIG. 4 is a rear elevational view thereof;
 FIG. 5 is a right elevational view thereof;
 FIG. 6 is a plan view thereof;
 FIG. 7 is a bottom view thereof;
 FIG. 8 is a front elevational view shown in an exploded condition; and,
 FIG. 9 is a left elevational view shown in an exploded condition.

1 Claim, 5 Drawing Sheets

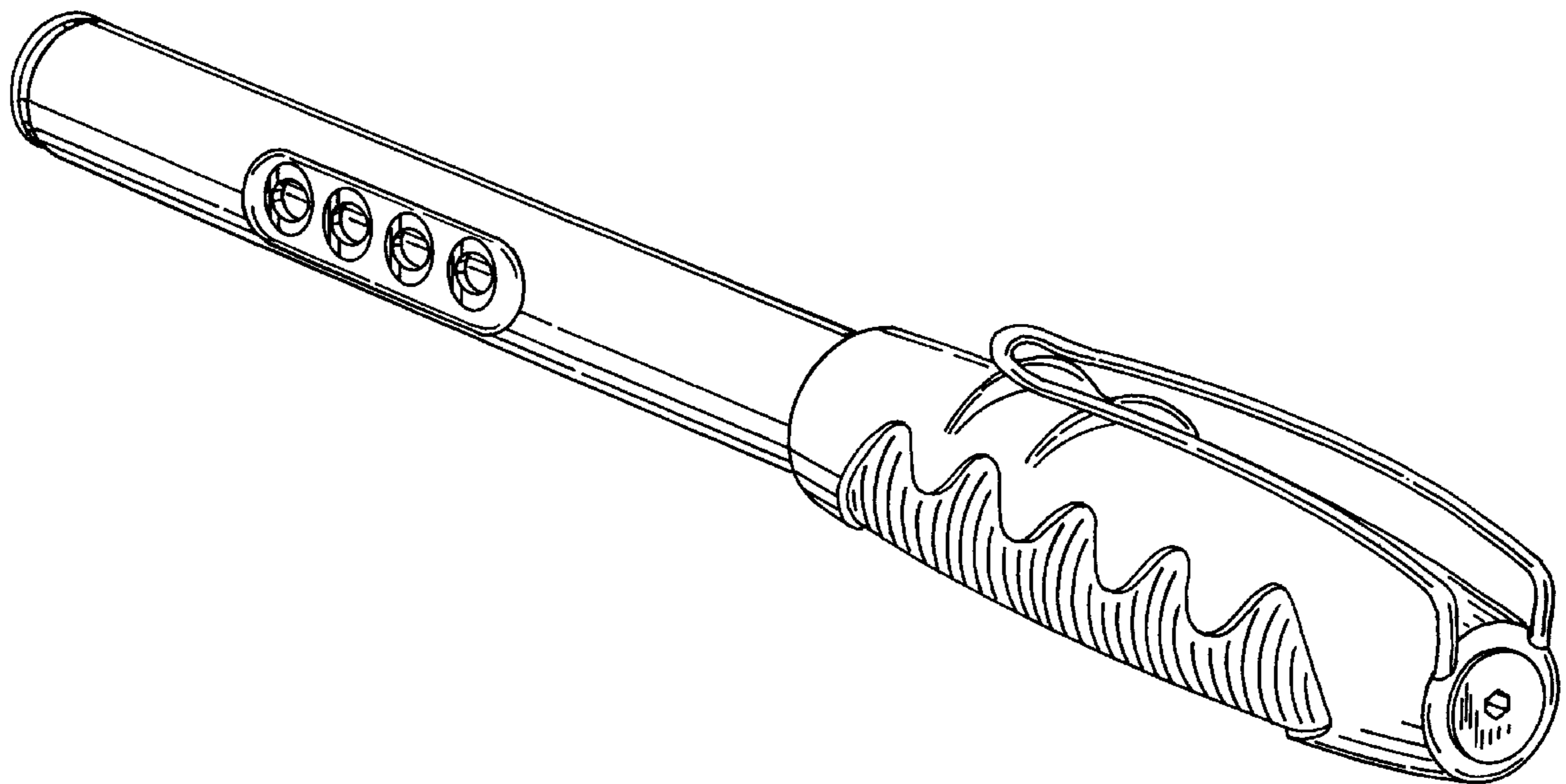

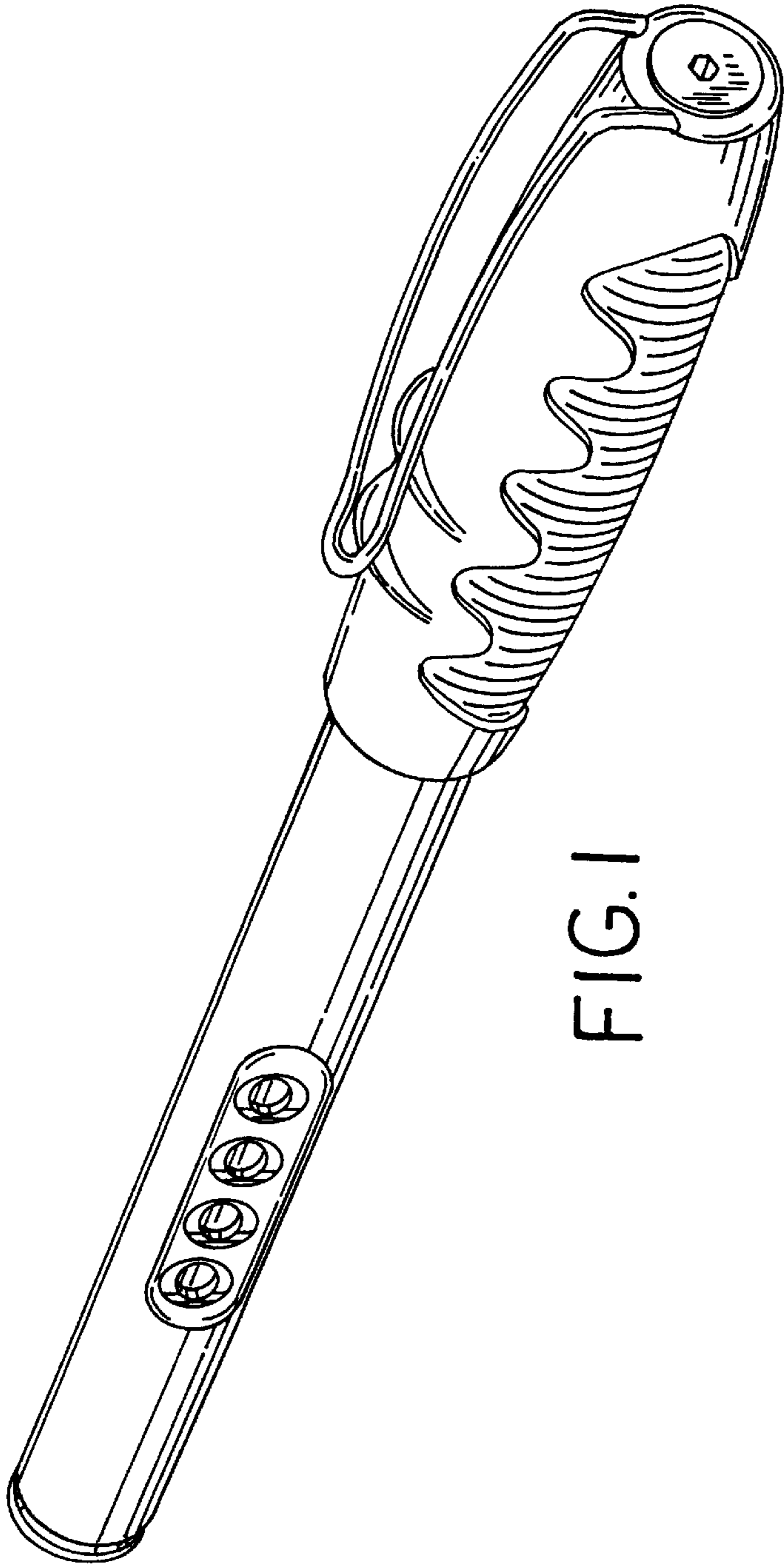

FIG. 1

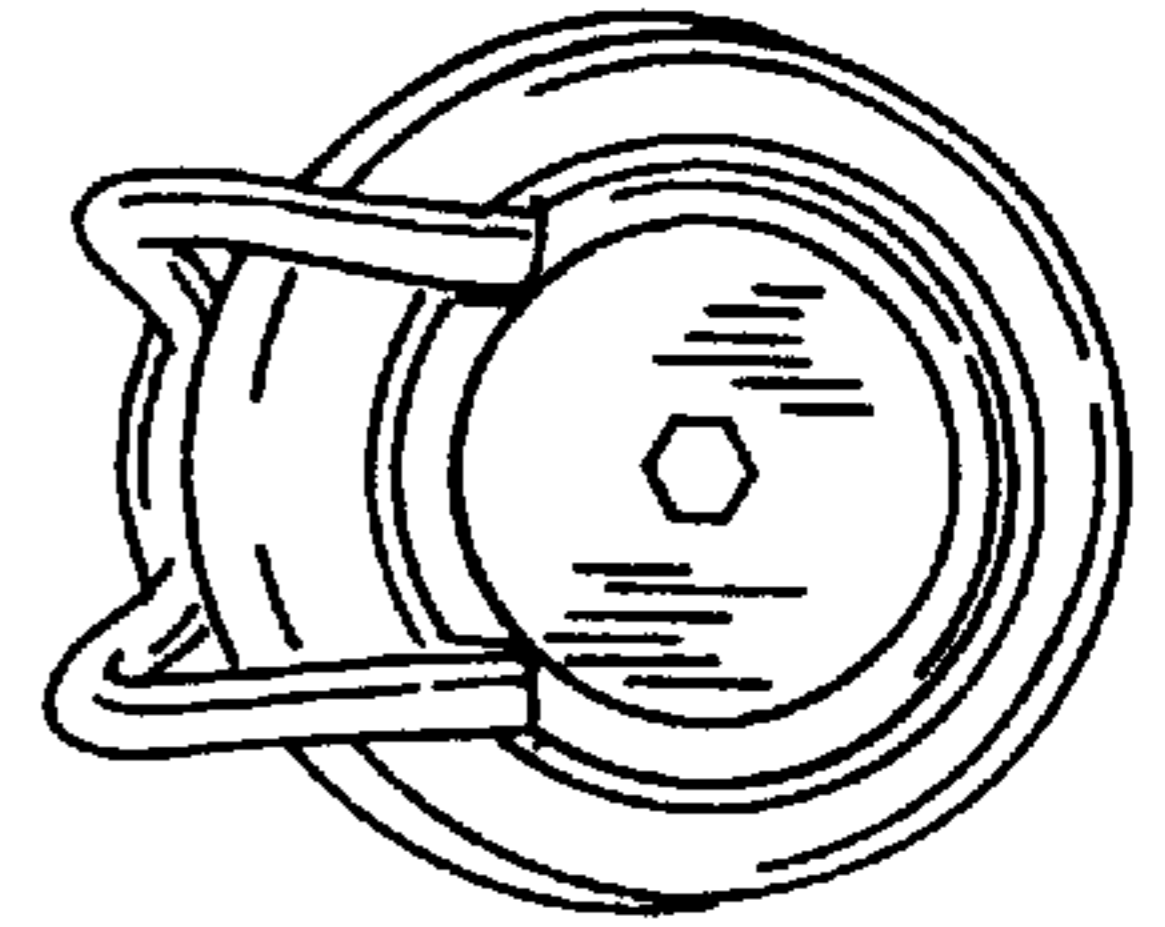

FIG. 7

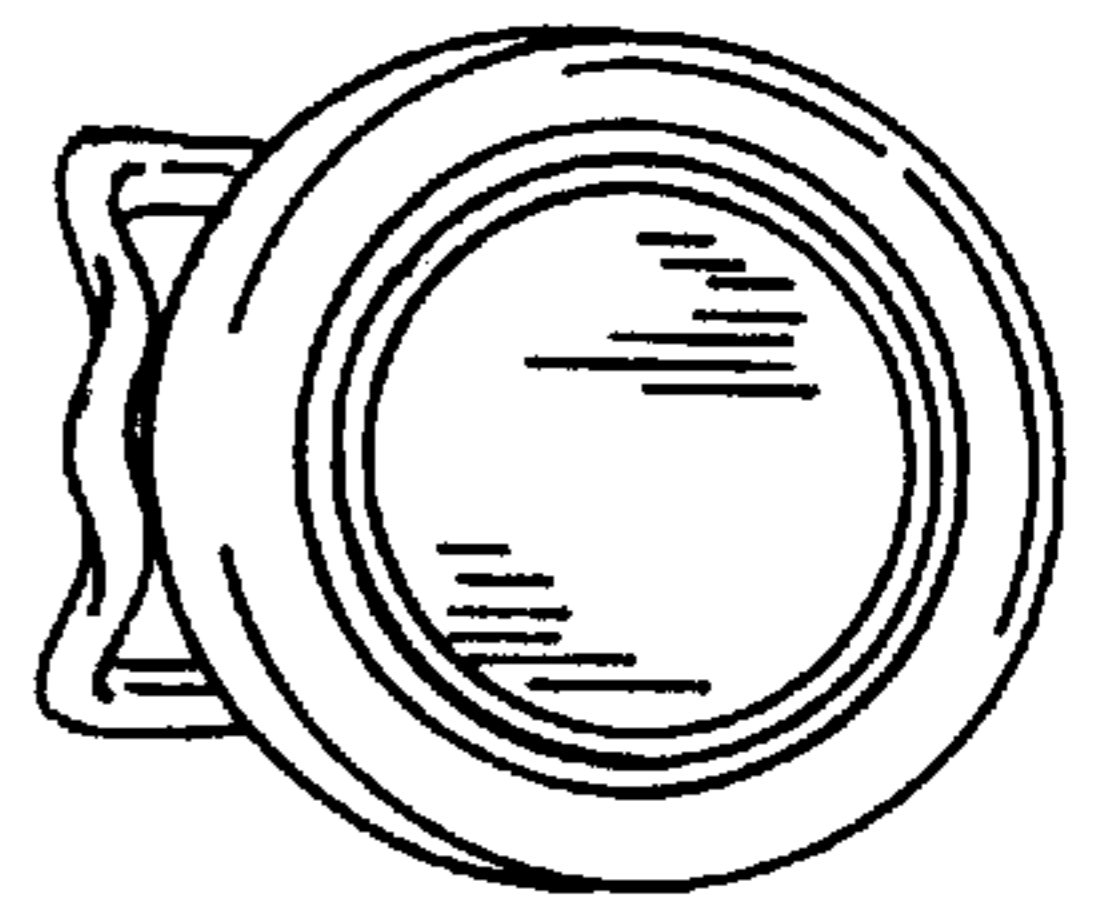

FIG. 6

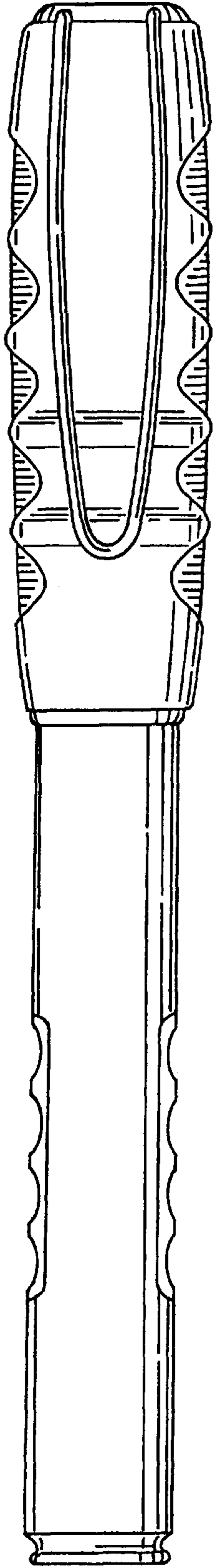

FIG. 2

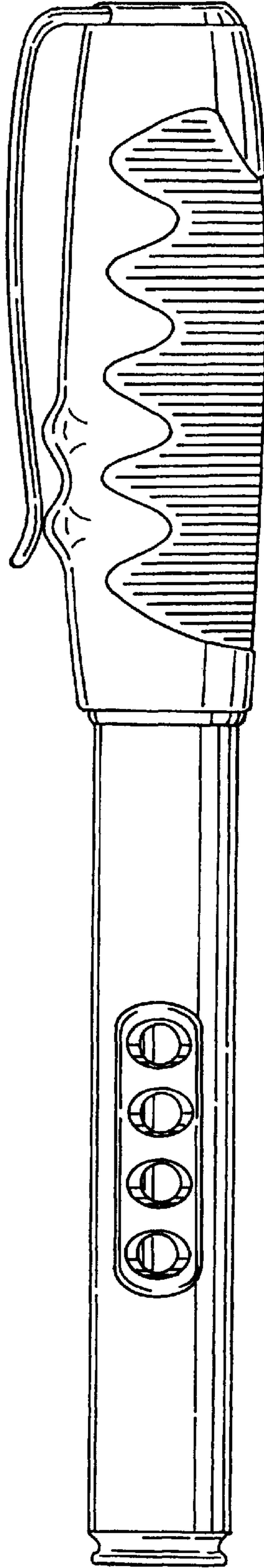

FIG. 3

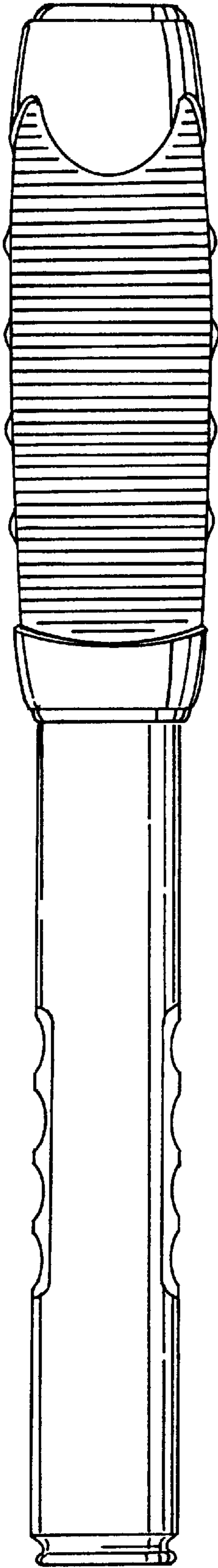

FIG. 4

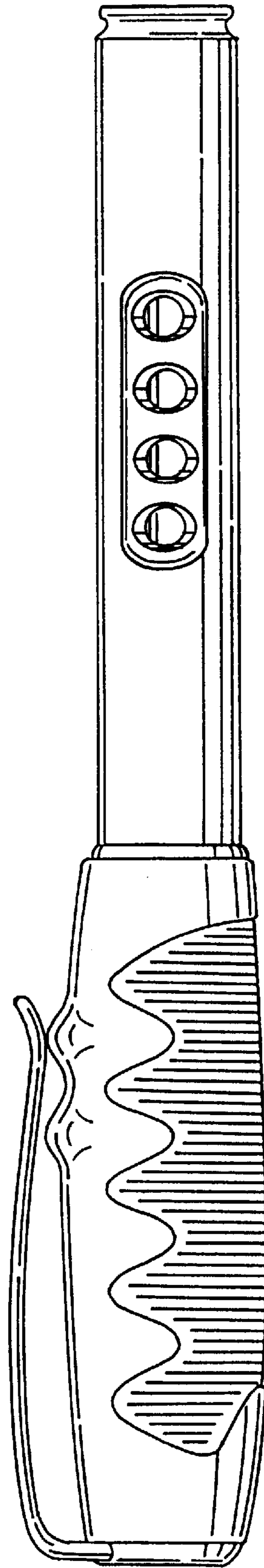

FIG. 5

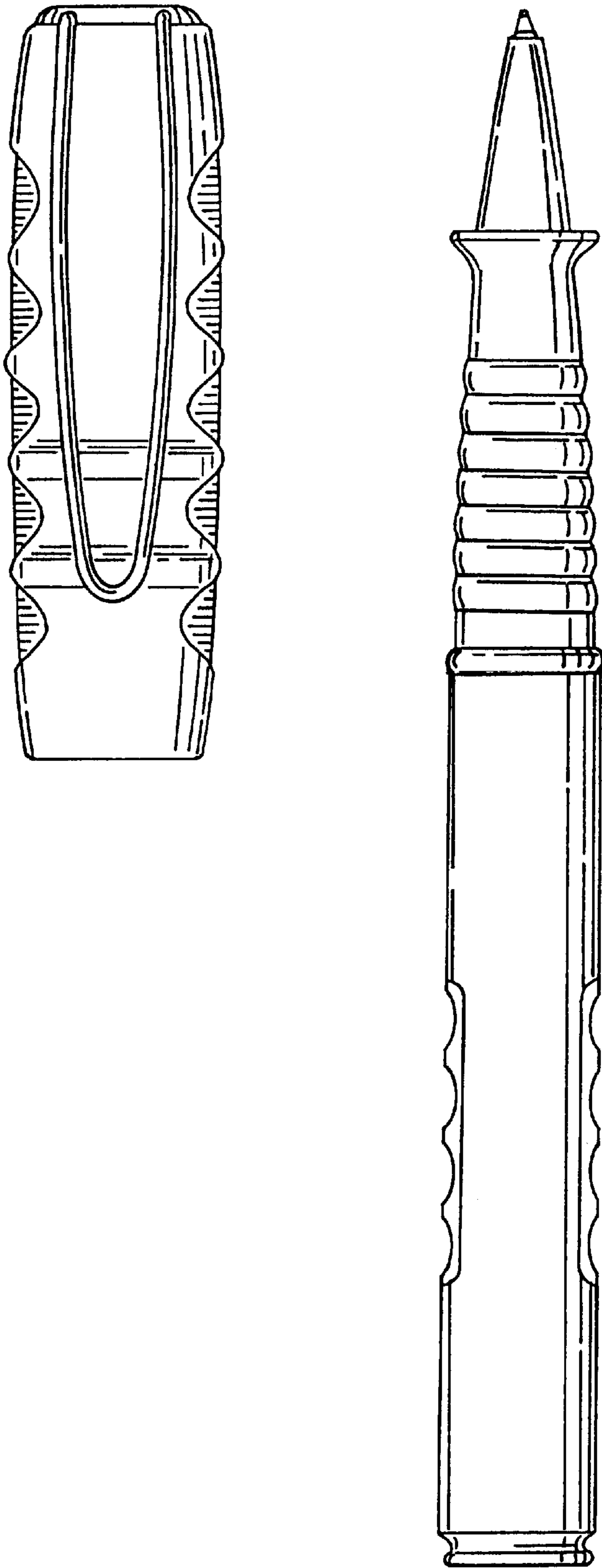

FIG. 8

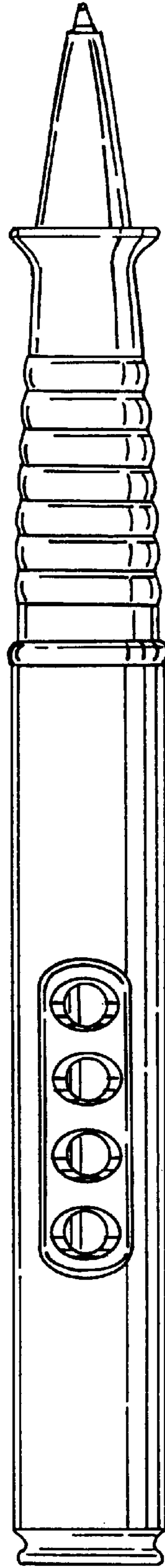
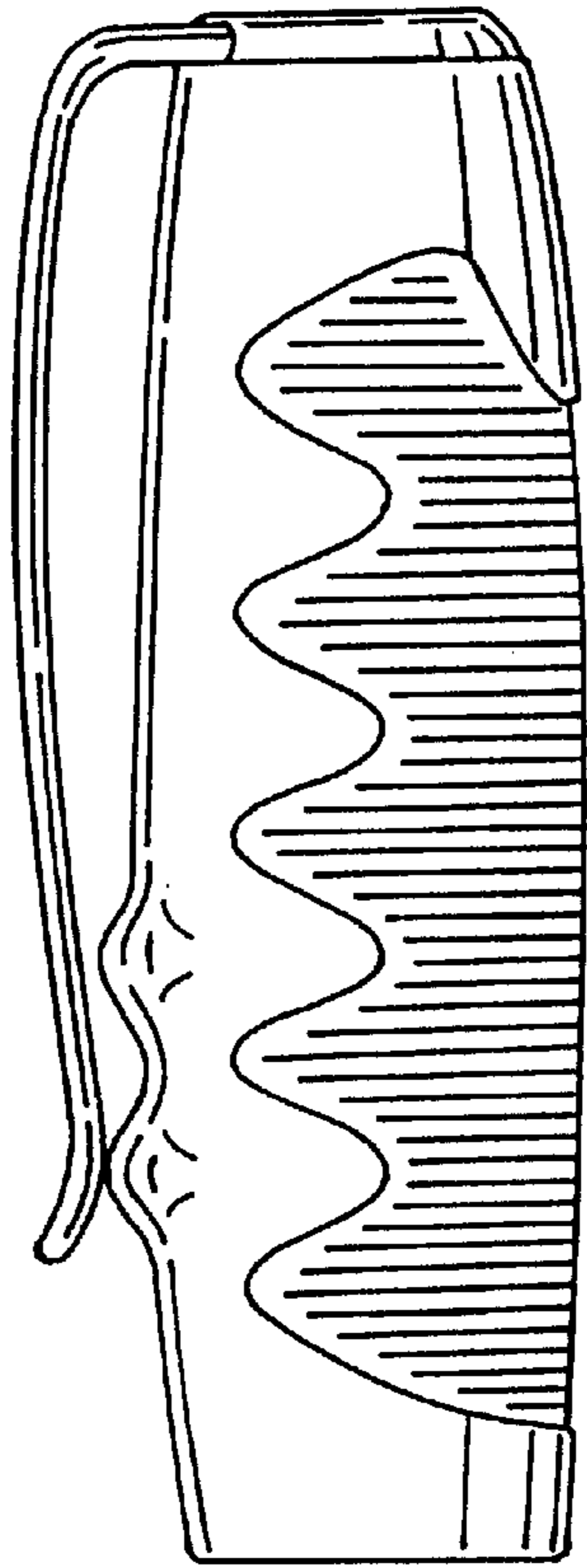

FIG. 9