



US00D446135S

(12) **United States Design Patent**
Chen

(10) **Patent No.:** **US D446,135 S**

(45) **Date of Patent:** **** Aug. 7, 2001**

(54) **THERMOMETER**

(76) Inventor: **Li-Chuan Chen**, 7th Fl., No. 31, Lane
513, Ruikwang Rd., Taipei (TW)

(**) Term: **14 Years**

(21) Appl. No.: **29/132,187**

(22) Filed: **Nov. 6, 2000**

(51) **LOC (7) Cl.** **10-04**

(52) **U.S. Cl.** **D10/57; D10/78**

(58) **Field of Search** **D10/57, 78; 374/208;**
324/115, 767, 768

(56) **References Cited**

U.S. PATENT DOCUMENTS

- D. 399,768 * 10/1998 Schwan D10/57
- D. 400,808 * 11/1998 Schwan D10/57
- D. 410,204 * 5/1999 Hendriks D10/78

* cited by examiner

Primary Examiner—Antoine Duval Davis
(74) *Attorney, Agent, or Firm*—Bacon & Thomas, PLLC

(57) **CLAIM**

The ornamental design for a thermometer, as shown.

DESCRIPTION

FIG. 1 is a front-right-top perspective view of a thermometer, showing my new design;
 FIG. 2 is a front elevational view thereof;
 FIG. 3 is a rear elevational view thereof;
 FIG. 4 is a left elevational view thereof;
 FIG. 5 is a right elevational view thereof;
 FIG. 6 is a top plan view thereof;
 FIG. 7 is a bottom plan view thereof; and,
 FIG. 8 is another right elevational view with the support stand shown extended.

1 Claim, 5 Drawing Sheets

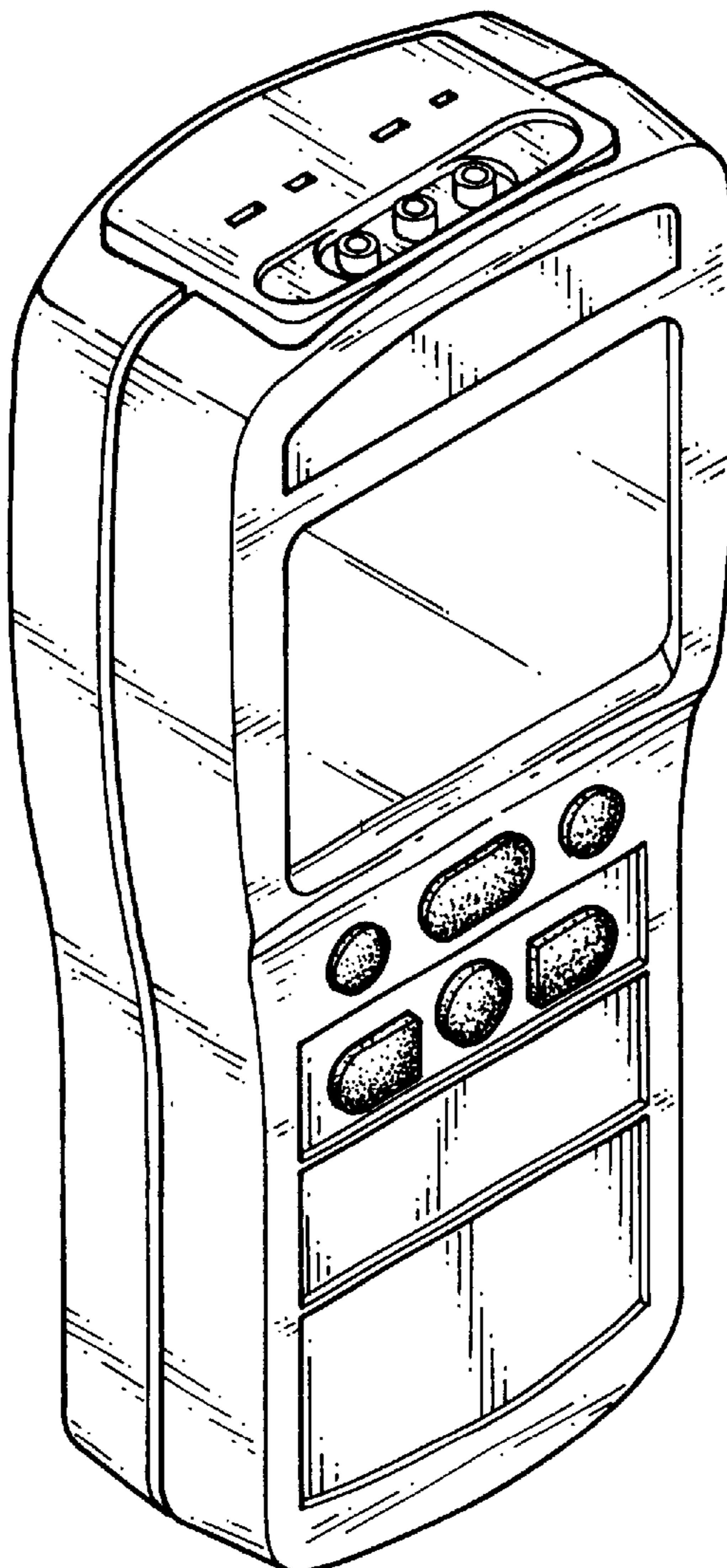

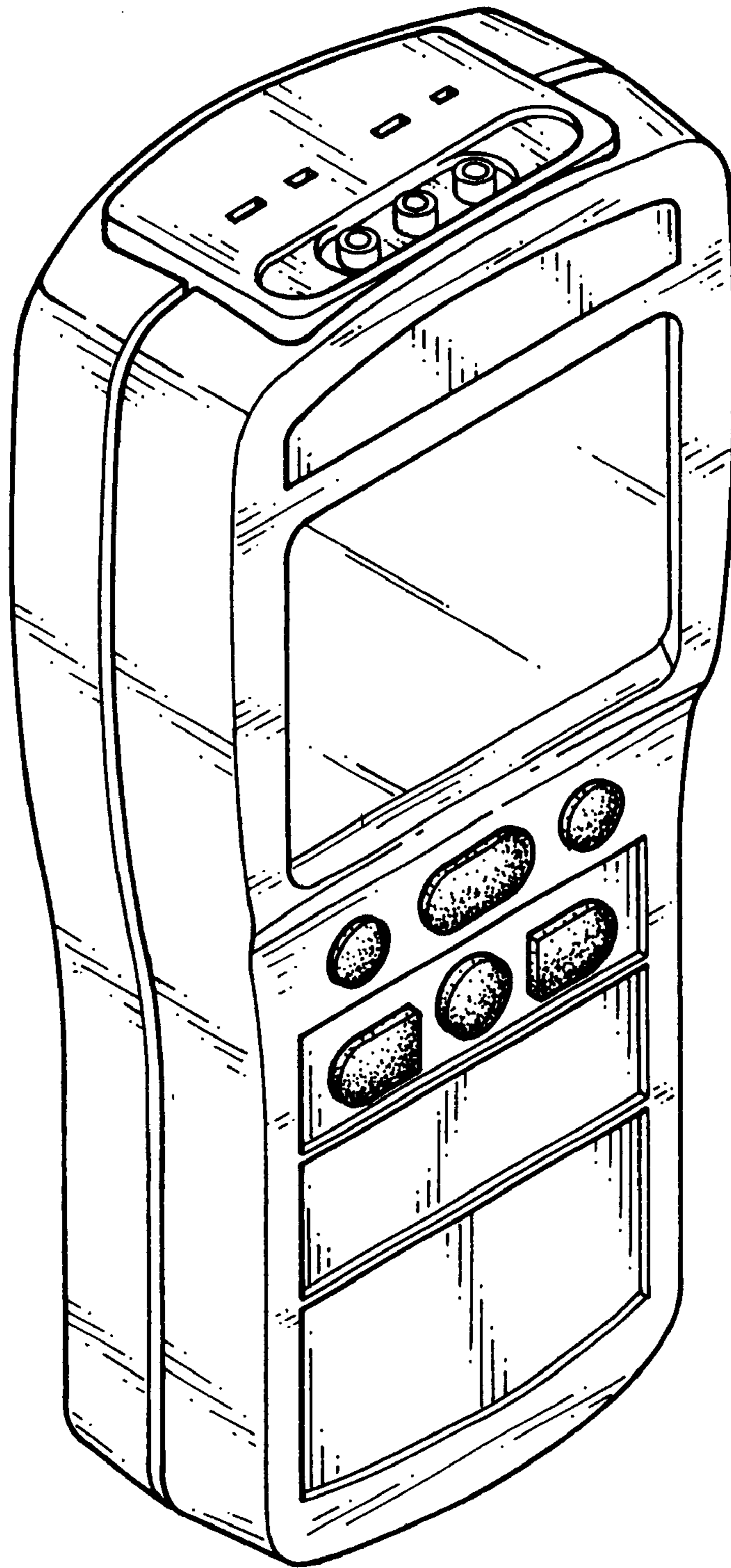

FIG. 1

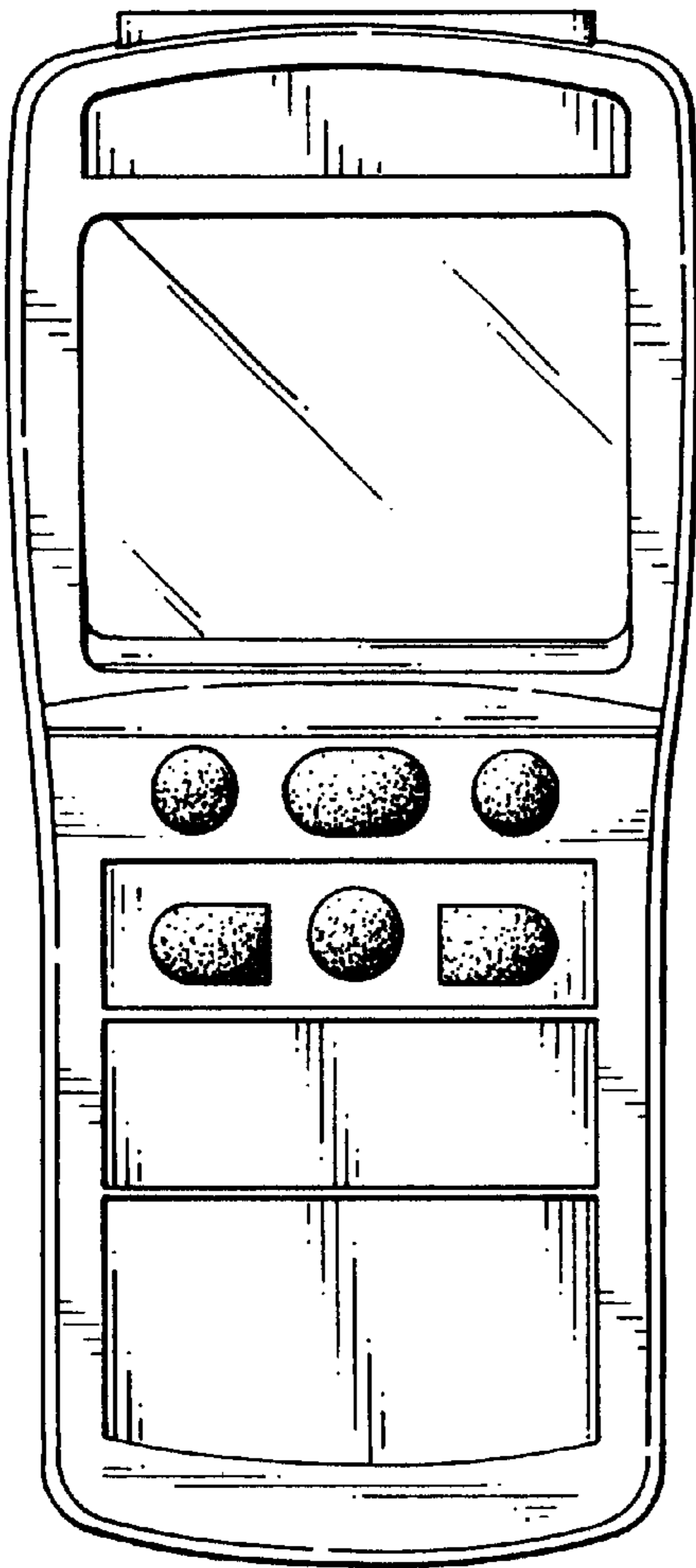

FIG. 2

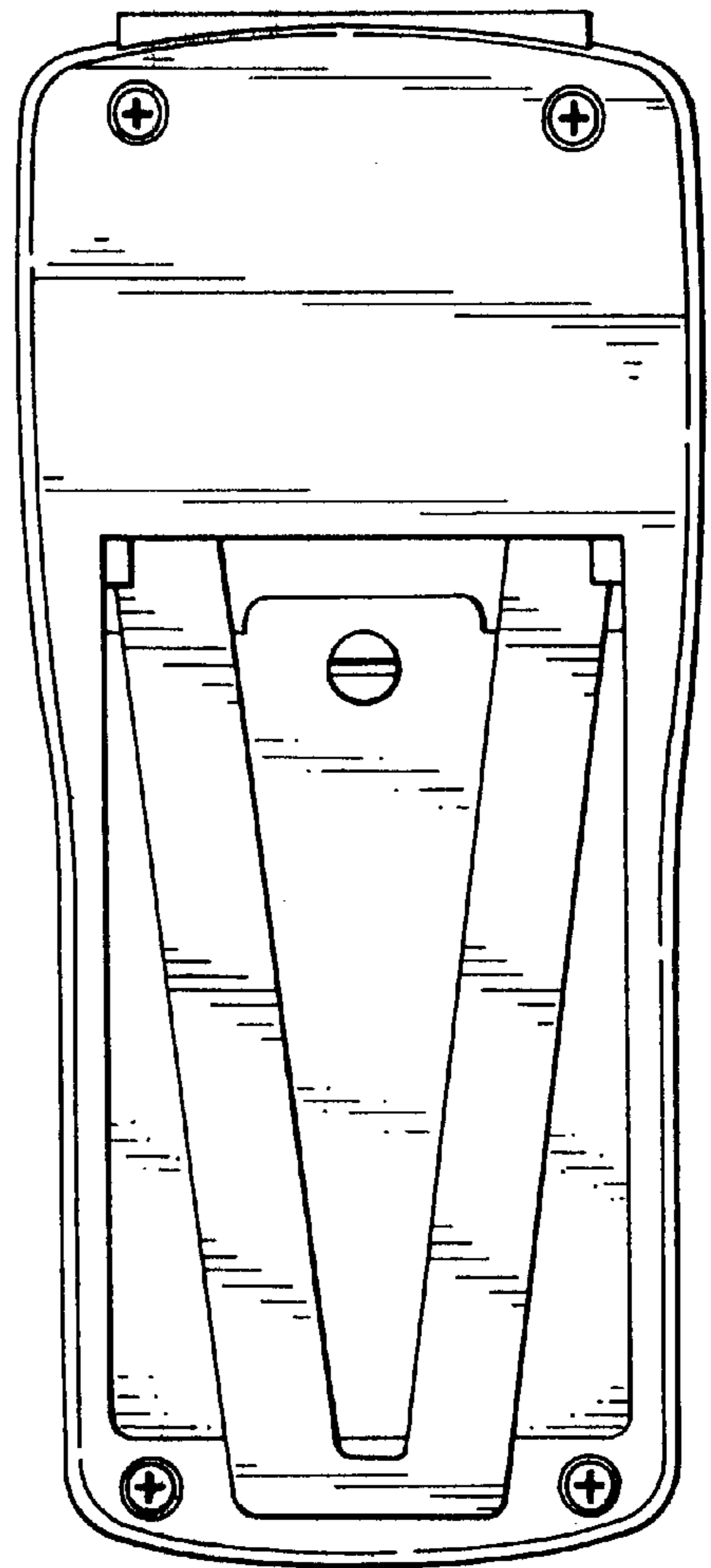

FIG. 3

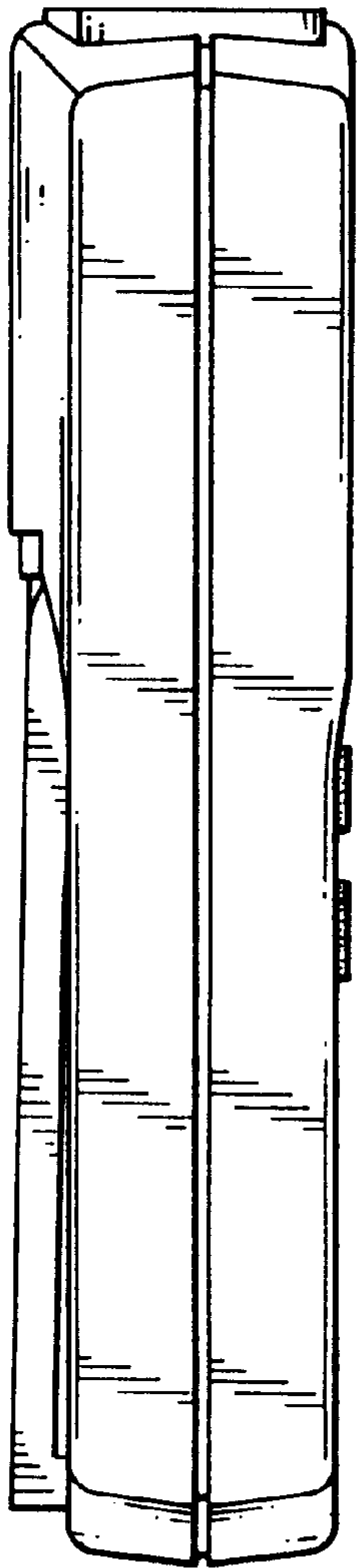

FIG. 4

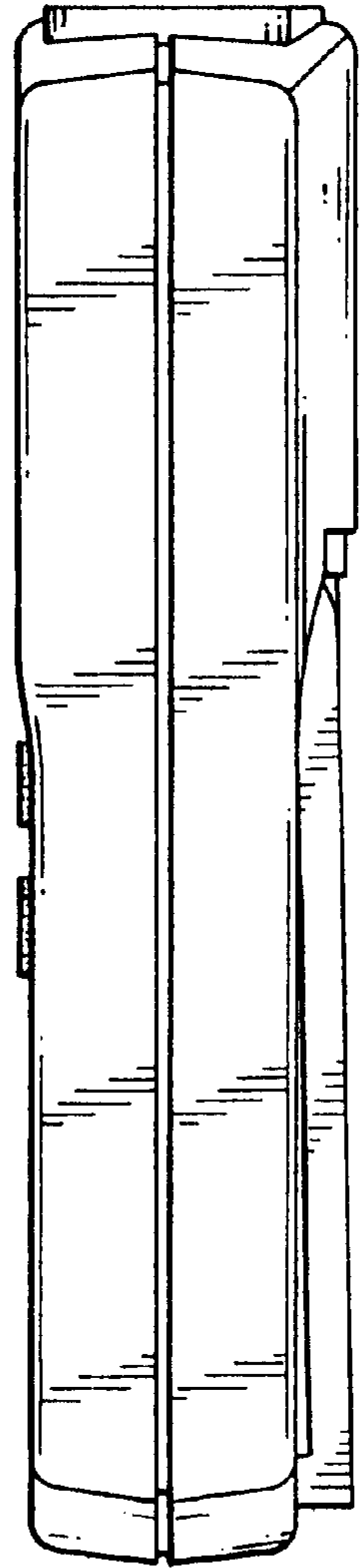

FIG. 5

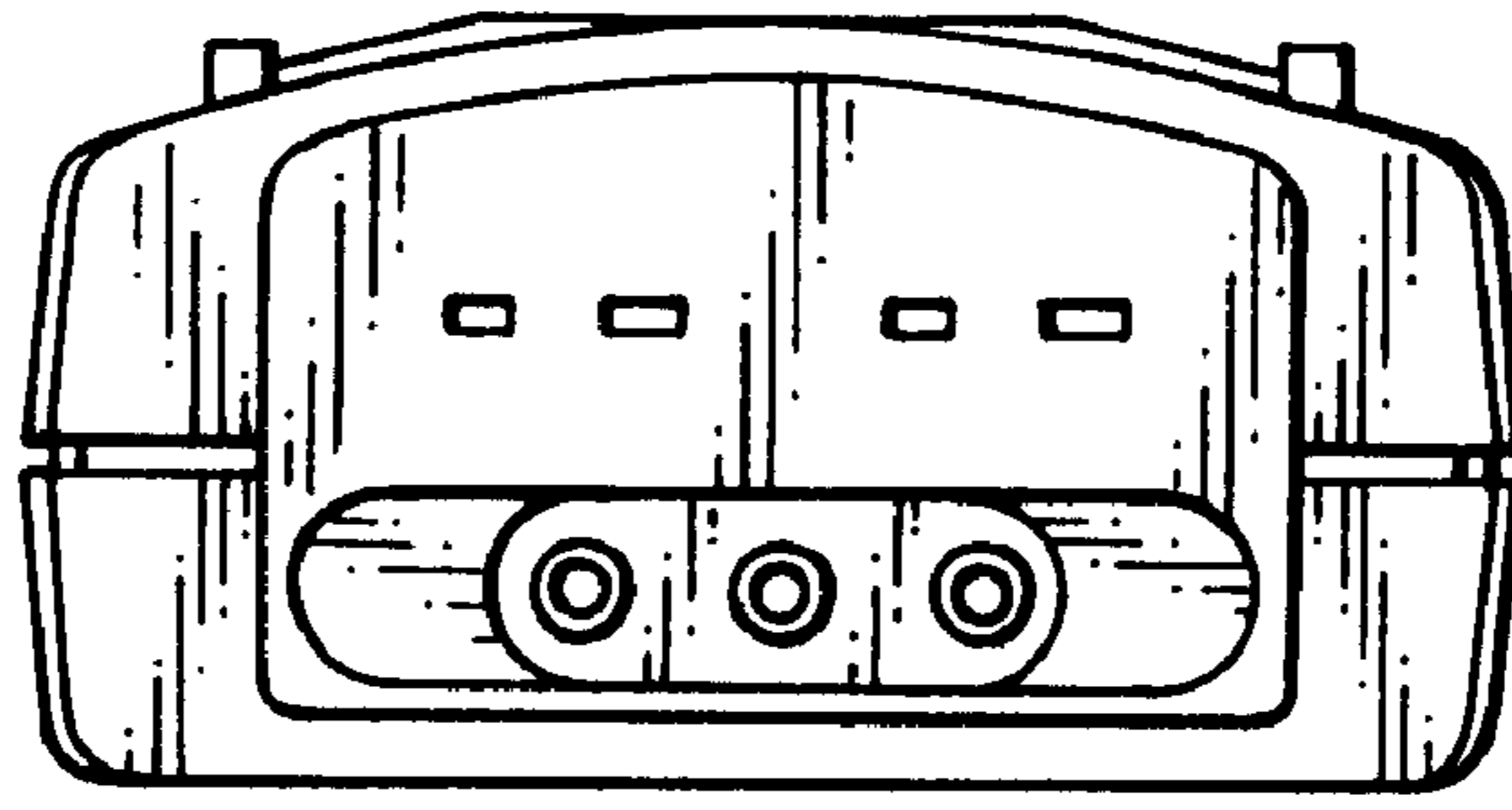

FIG. 6

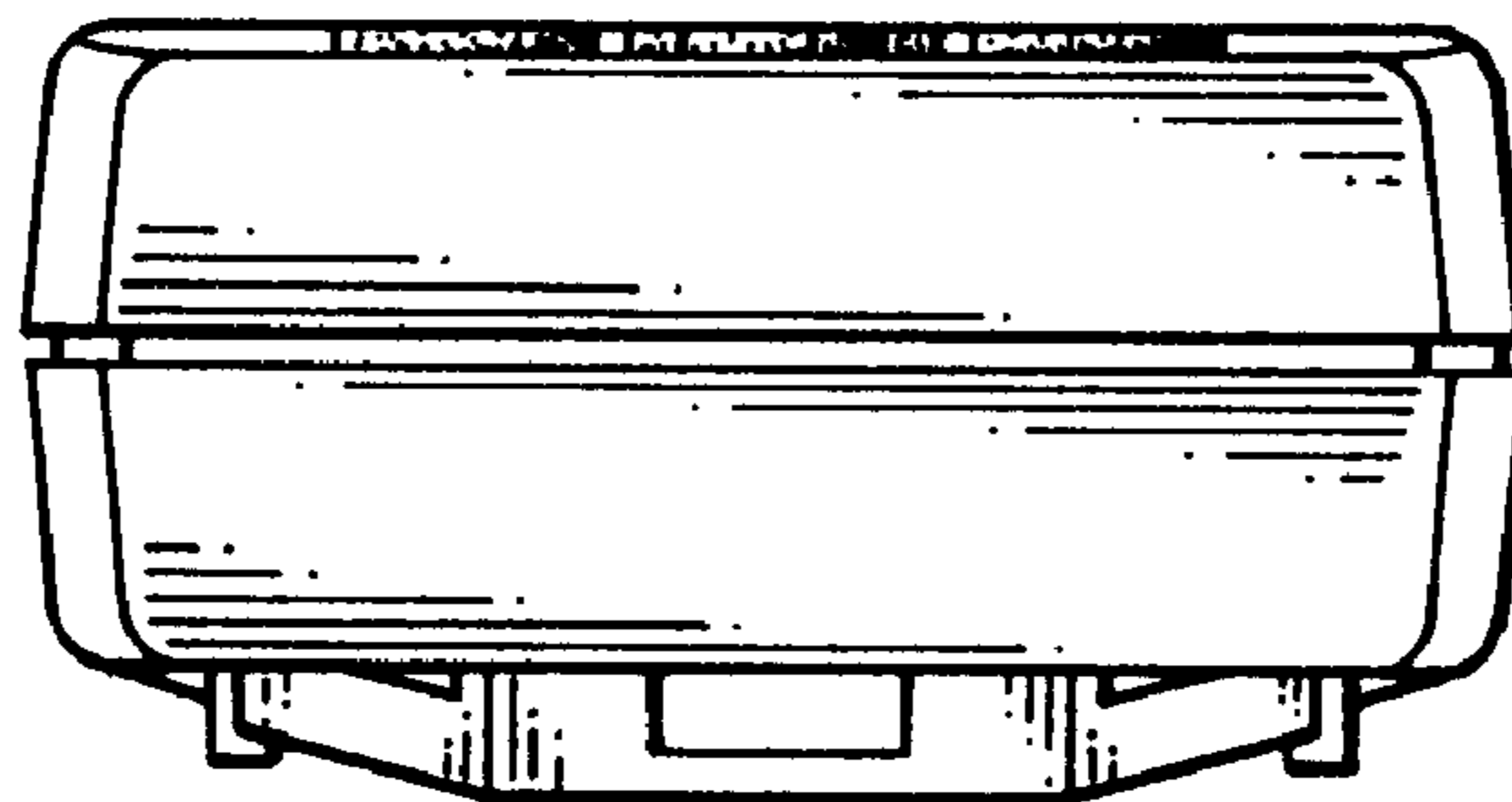

FIG. 7

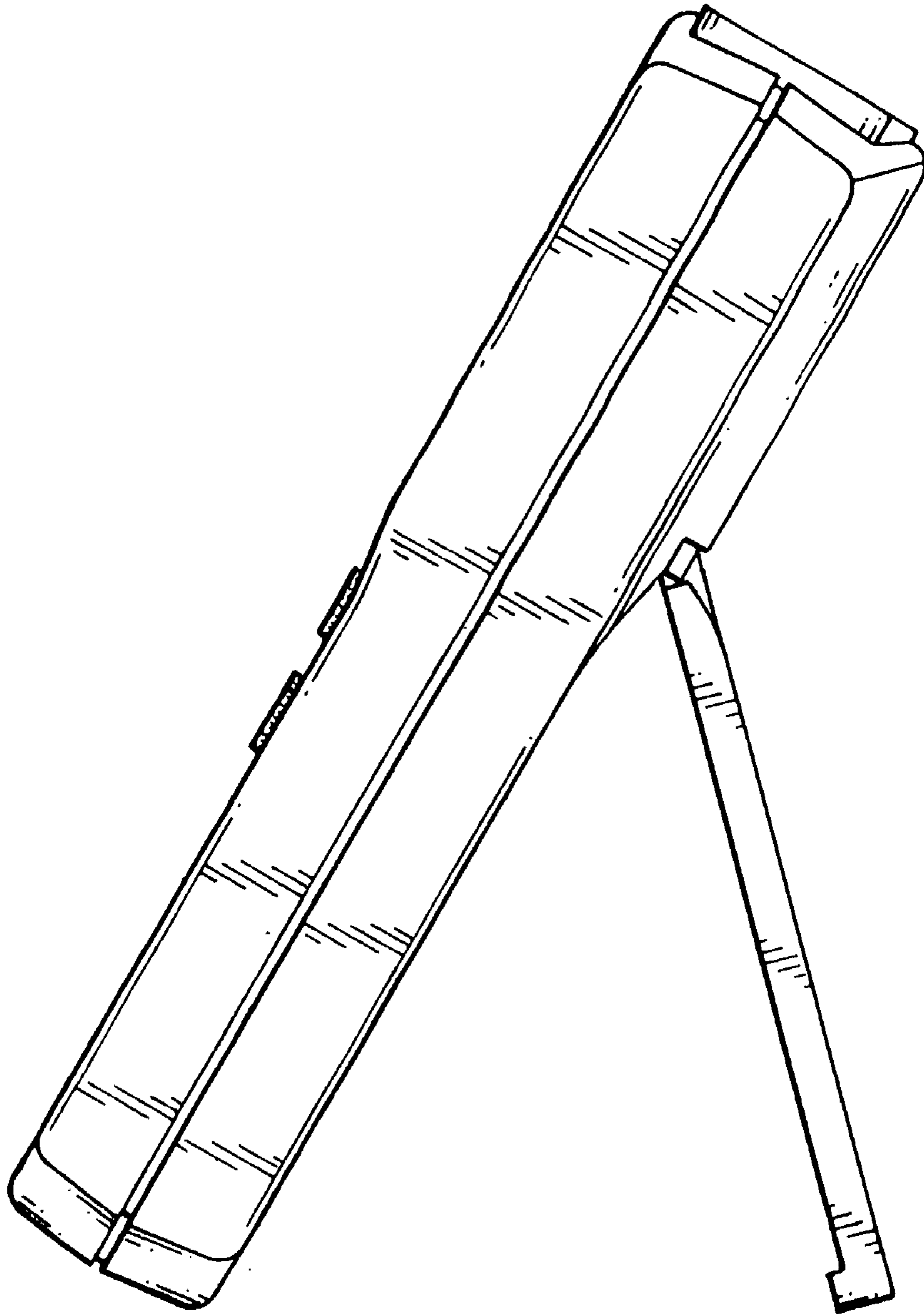

FIG. 8