



US00D446064S

(12) **United States Design Patent**
Noll

(10) **Patent No.:** **US D446,064 S**

(45) **Date of Patent:** **** Aug. 7, 2001**

(54) **SLATTED TABLE TOP**

DESCRIPTION

(76) Inventor: **Ronald C. Noll**, 25 Fiarway Trail,
Moreland Hills, OH (US) 44022

(**) Term: **14 Years**

(21) Appl. No.: **29/136,561**

(22) Filed: **Feb. 1, 2001**

Related U.S. Application Data

(62) Division of application No. 29/119,043, filed on Feb. 23,
2000, now Pat. No. Des. 440,087.

(51) **LOC (7) Cl.** **06-06**

(52) **U.S. Cl.** **D6/511**

(58) **Field of Search** D6/480-489, 511;
108/150, 151, 153.1, 156, 157.1, 161

(56) **References Cited**

U.S. PATENT DOCUMENTS

D. 189,785	2/1961	Swarts et al.	D6/430
D. 365,732	1/1996	Kellen et al.	D6/511 X
D. 412,254	7/1999	Gower	D6/480

OTHER PUBLICATIONS

- Country Casual, p. 57, table at top.*
- Schoner Wohnen, Apr. 1985, p. 202K, table at lower right.*
- Smith and Hawken, p. 27, table.*
- Smith and Hawken, p. 33, table.

* cited by examiner

Primary Examiner—Janice E. Seeger
(74) *Attorney, Agent, or Firm*—Pearne & Gordon LLP

(57) **CLAIM**

The ornamental design for a slatted table top, as shown and described.

FIG. 1 is a perspective view of a first embodiment of a slatted table top having a plurality of slots which extend all the way through the table top, showing my new design;
 FIG. 2 is a top plan view thereof;
 FIG. 3 is a front elevational view thereof;
 FIG. 4 is a right side elevational view thereof, the left side elevational view being identical;
 FIG. 5 is a bottom plan view thereof.
 FIG. 6 is a perspective view of a second embodiment of a slatted table top having a plurality of slots which extend all the way through the table top, showing my new design;
 FIG. 7 is a top plan view thereof;
 FIG. 8 is a front elevational view thereof;
 FIG. 9 is a right side elevational view thereof, the left side elevational view being identical;
 FIG. 10 is a bottom plan view thereof.
 FIG. 11 is a perspective view of a third embodiment of a slatted table top having a plurality of grooves in the top surface of the table top which do not extend all the way through the table top, showing my new design;
 FIG. 12 is a top plan view thereof;
 FIG. 13 is a front elevational view thereof;
 FIG. 14 is a right side elevational view thereof, the left side elevational view being identical;
 FIG. 15 is a bottom plan view thereof.
 FIG. 16 is a perspective view of a fourth embodiment of a slatted table top having a plurality of grooves in the top surface of the table top which do not extend all the way through the table top, showing my new design;
 FIG. 17 is a top plan view thereof;
 FIG. 18 is a front elevational view thereof;
 FIG. 19 is a right side elevational view thereof, the left side elevational view being identical; and,
 FIG. 20 is a bottom plan view thereof.
 The broken lines are for environmental purposes only and form no part of the claimed design.

1 Claim, 12 Drawing Sheets

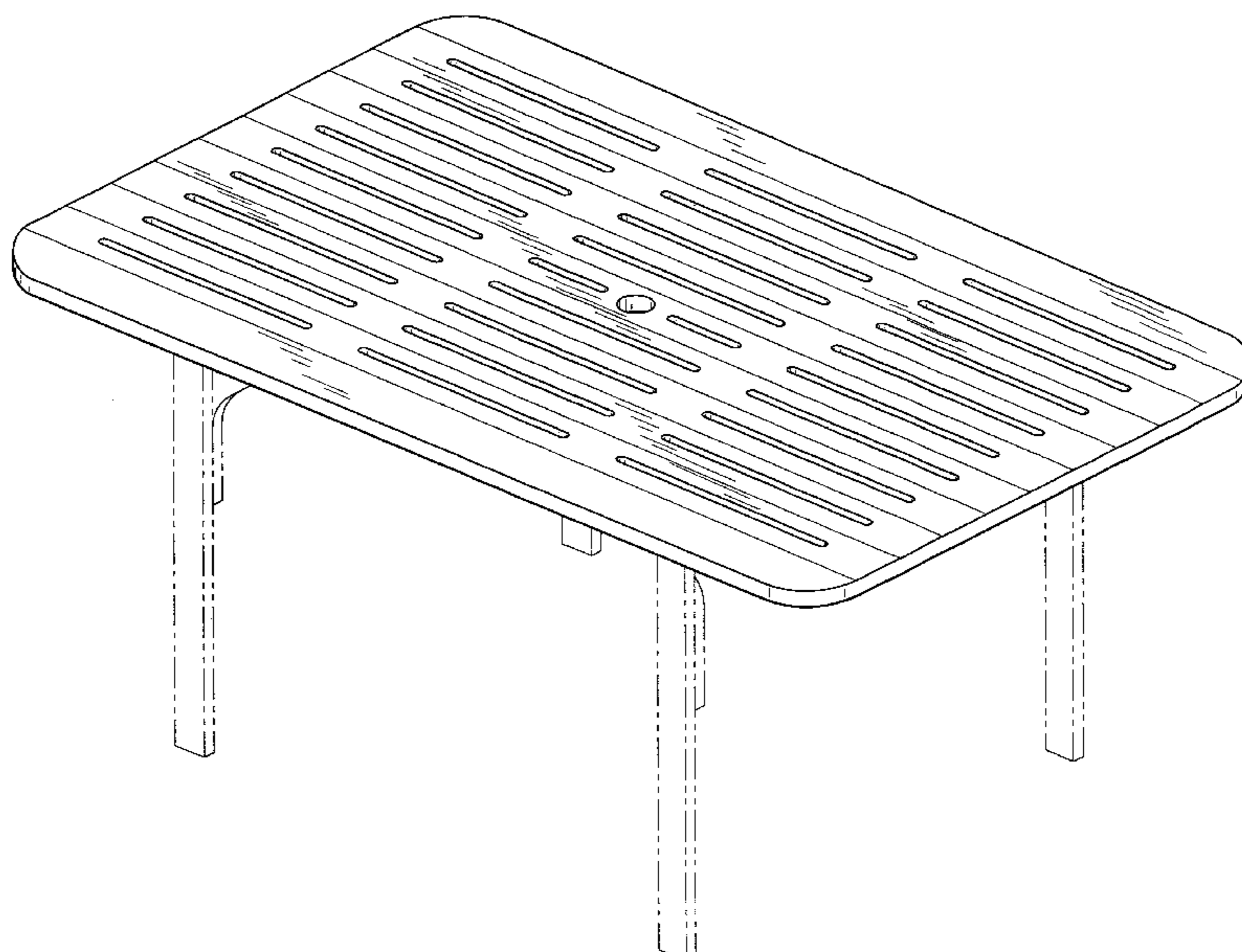

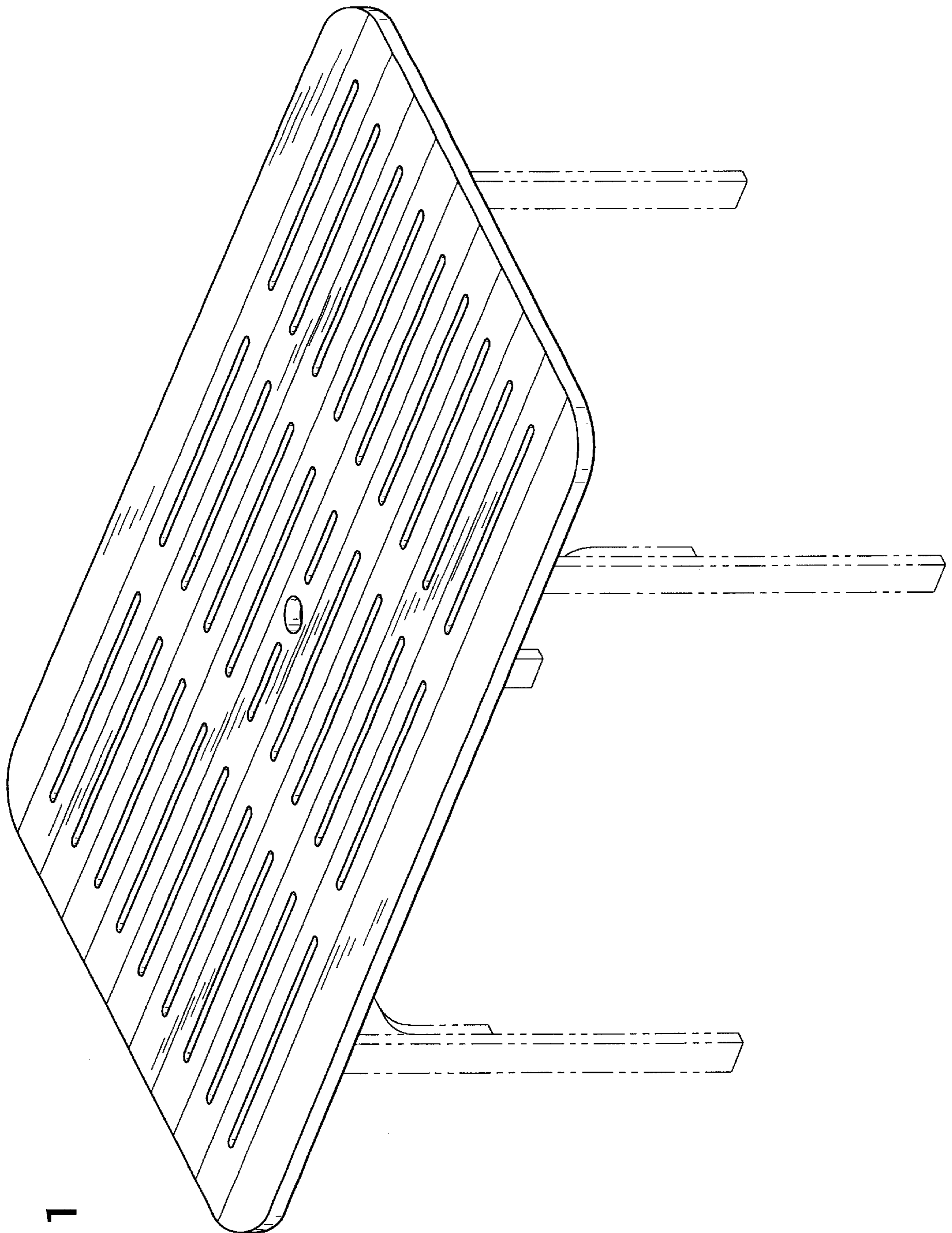

FIG. 1

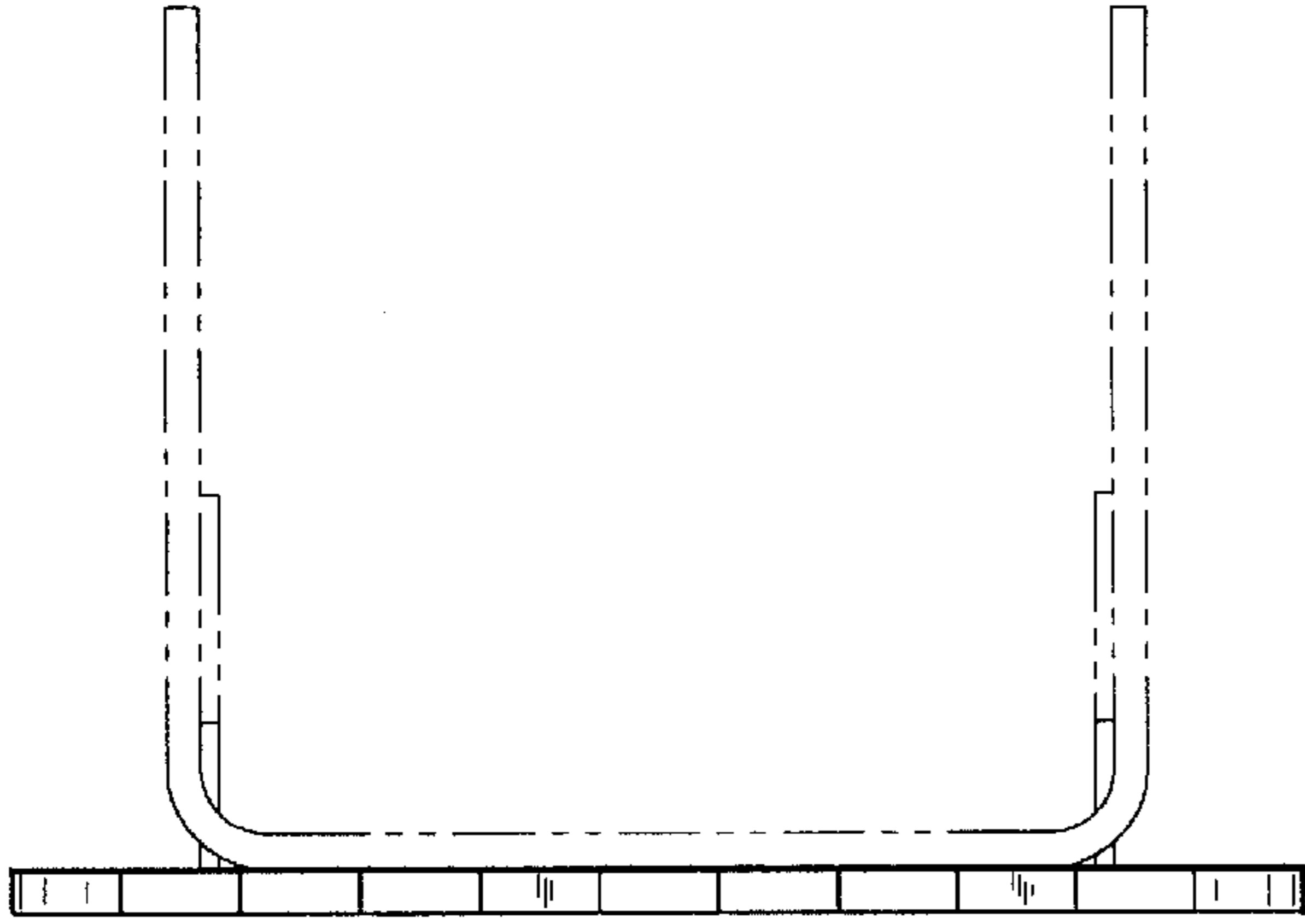

FIG. 3

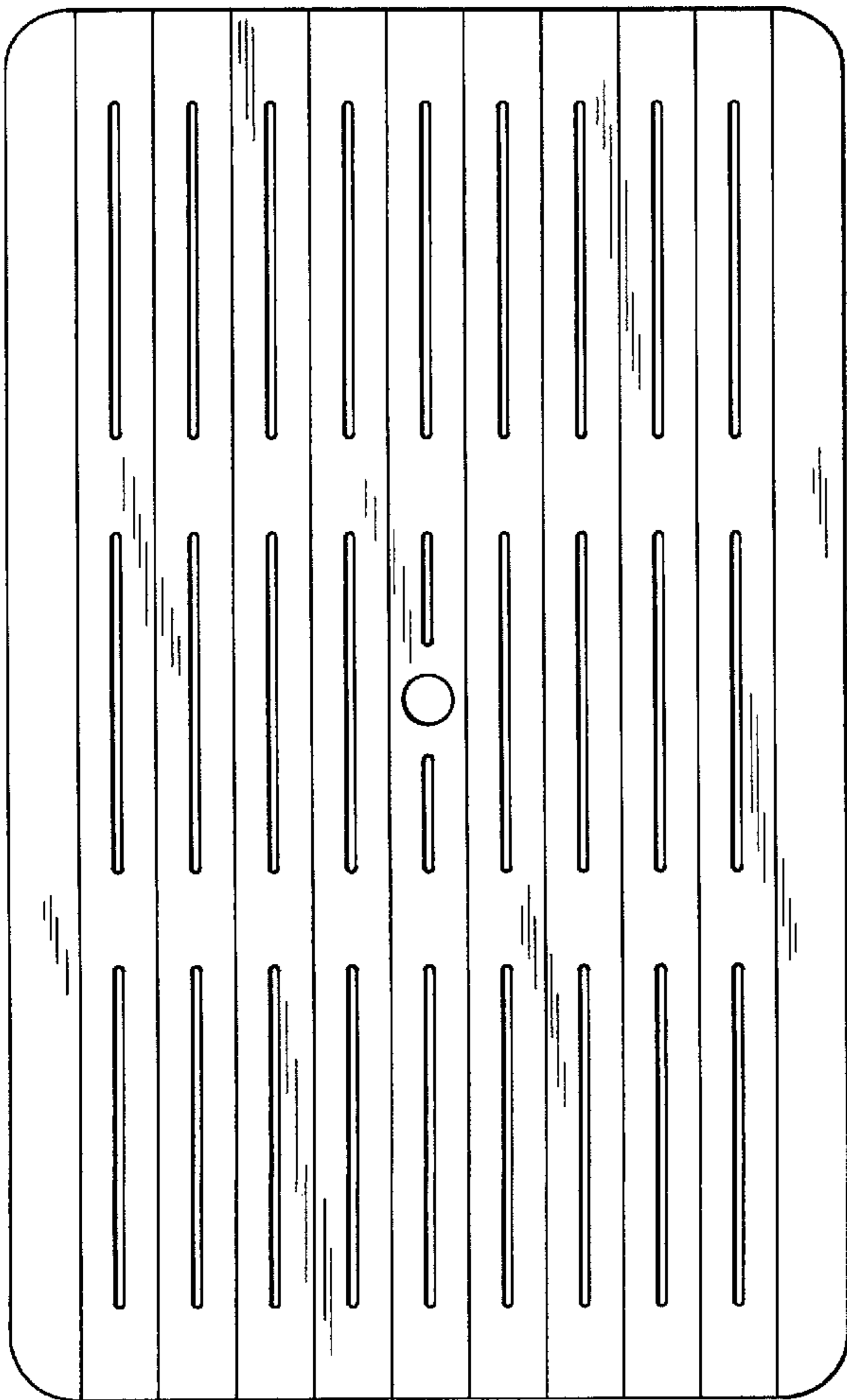

FIG. 2

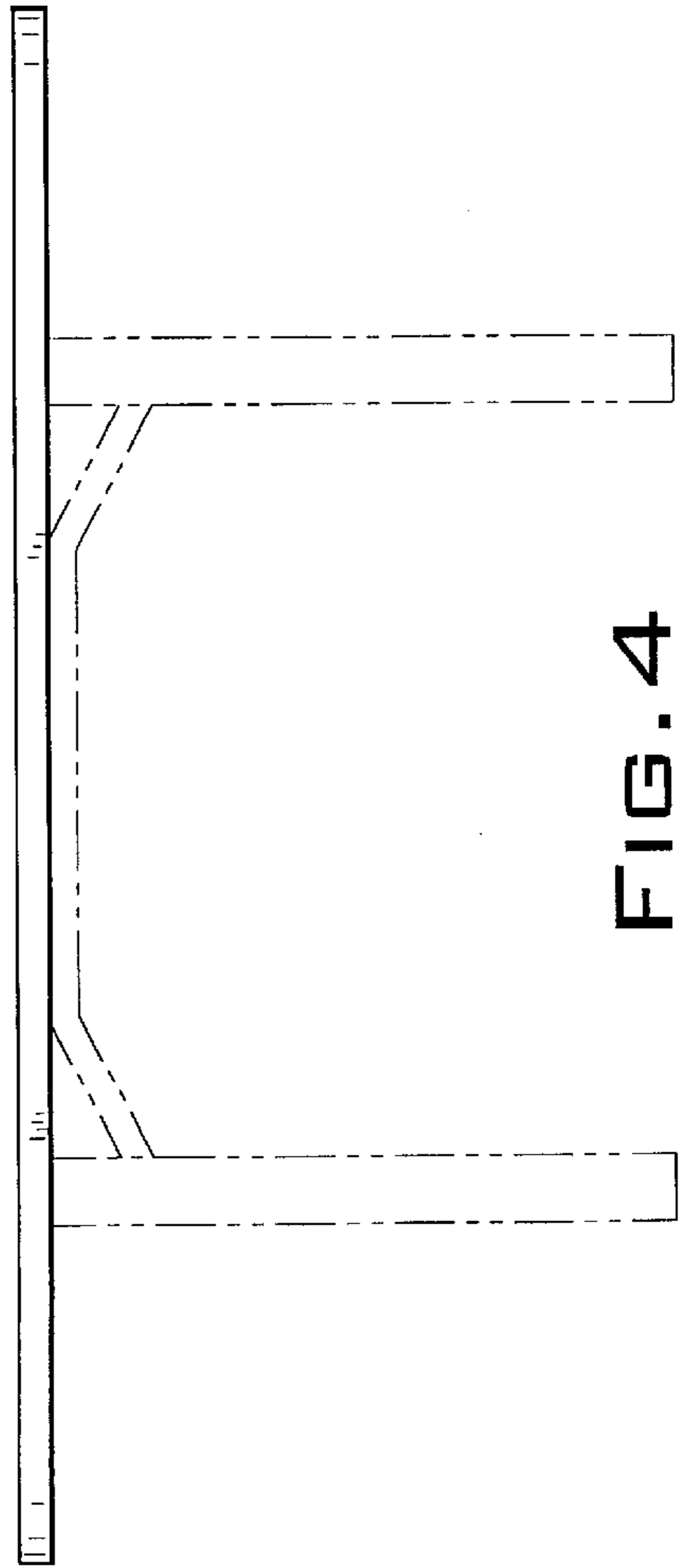

FIG. 4

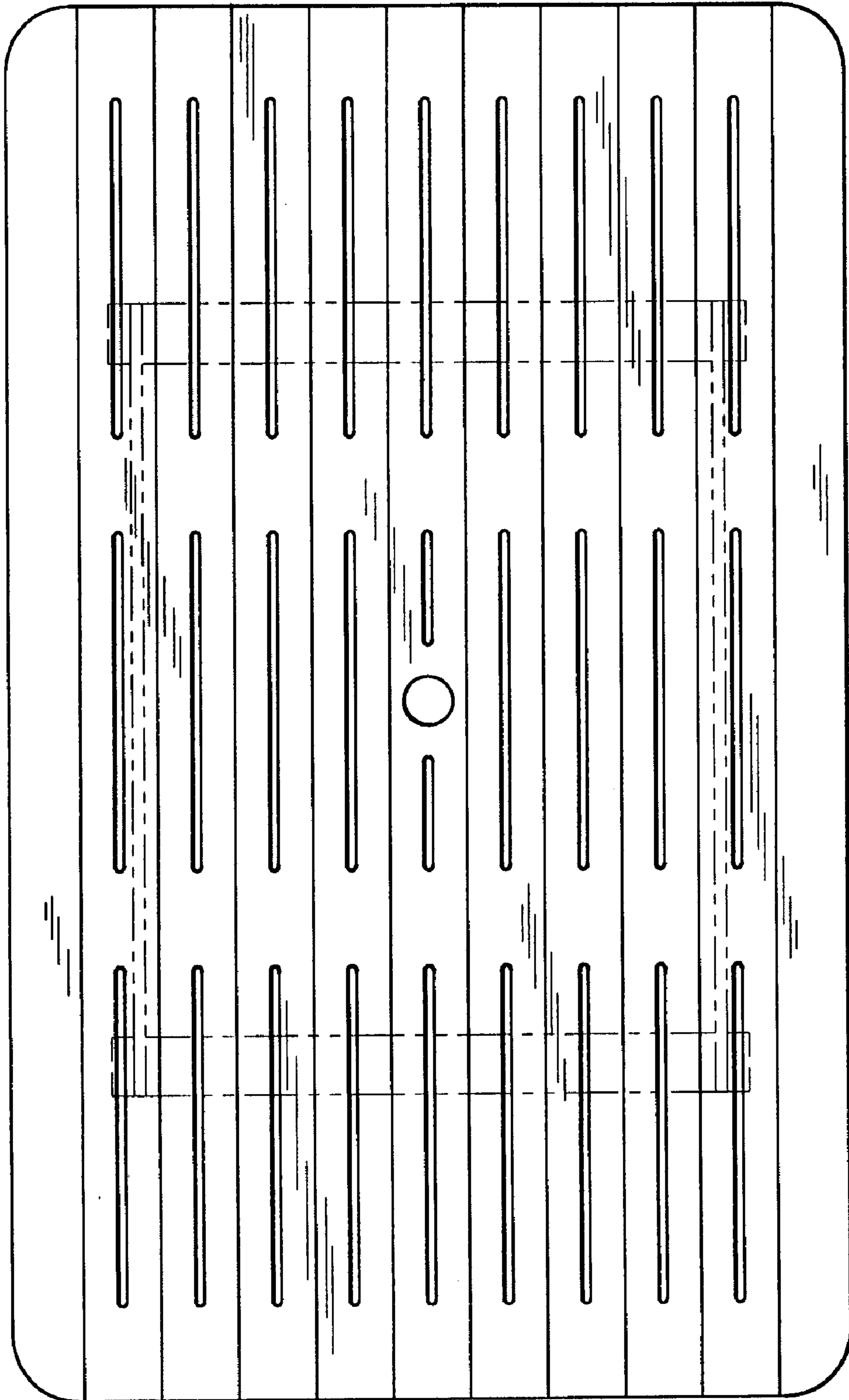

FIG. 5

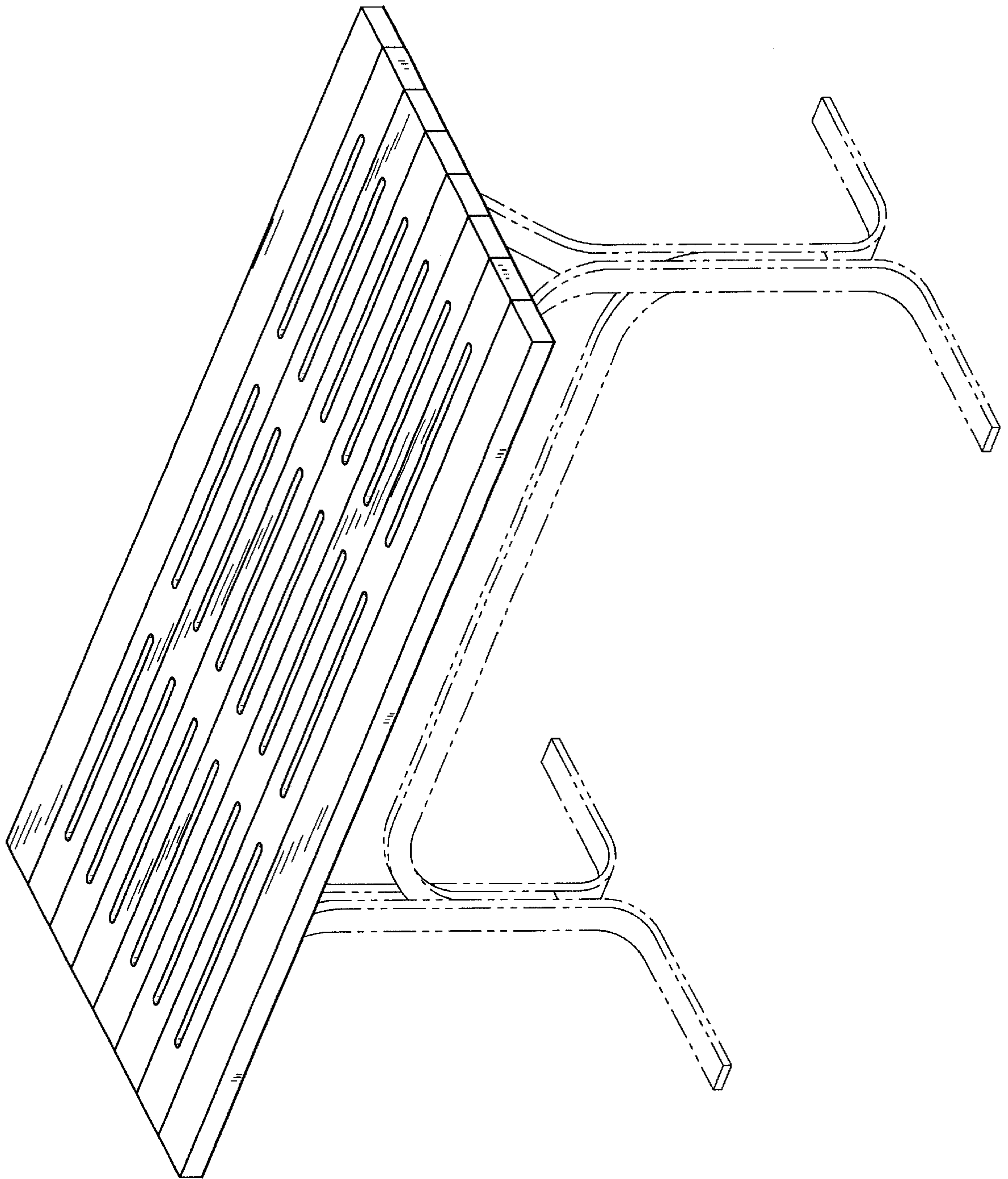

FIG. 6

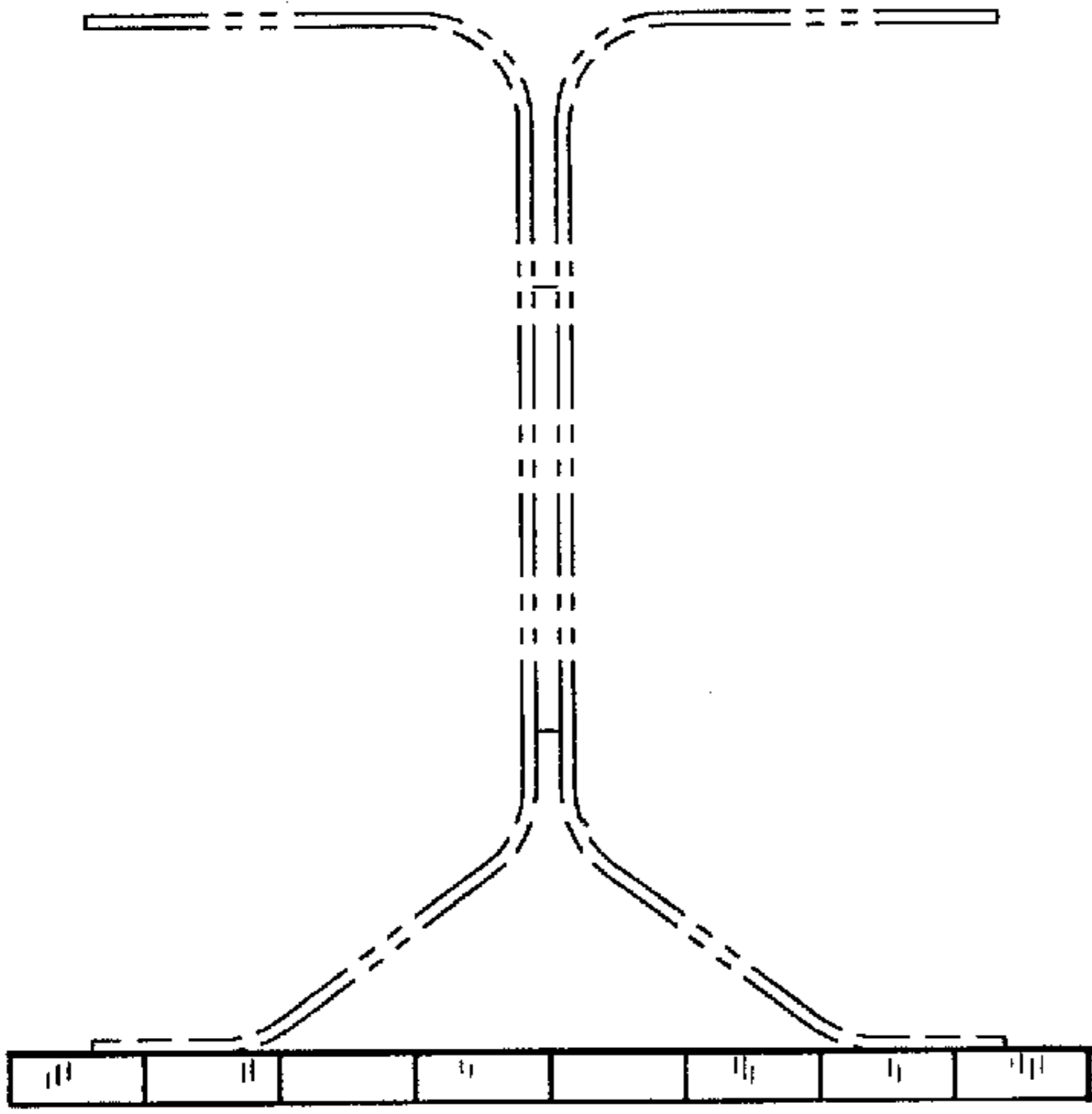

FIG. 8

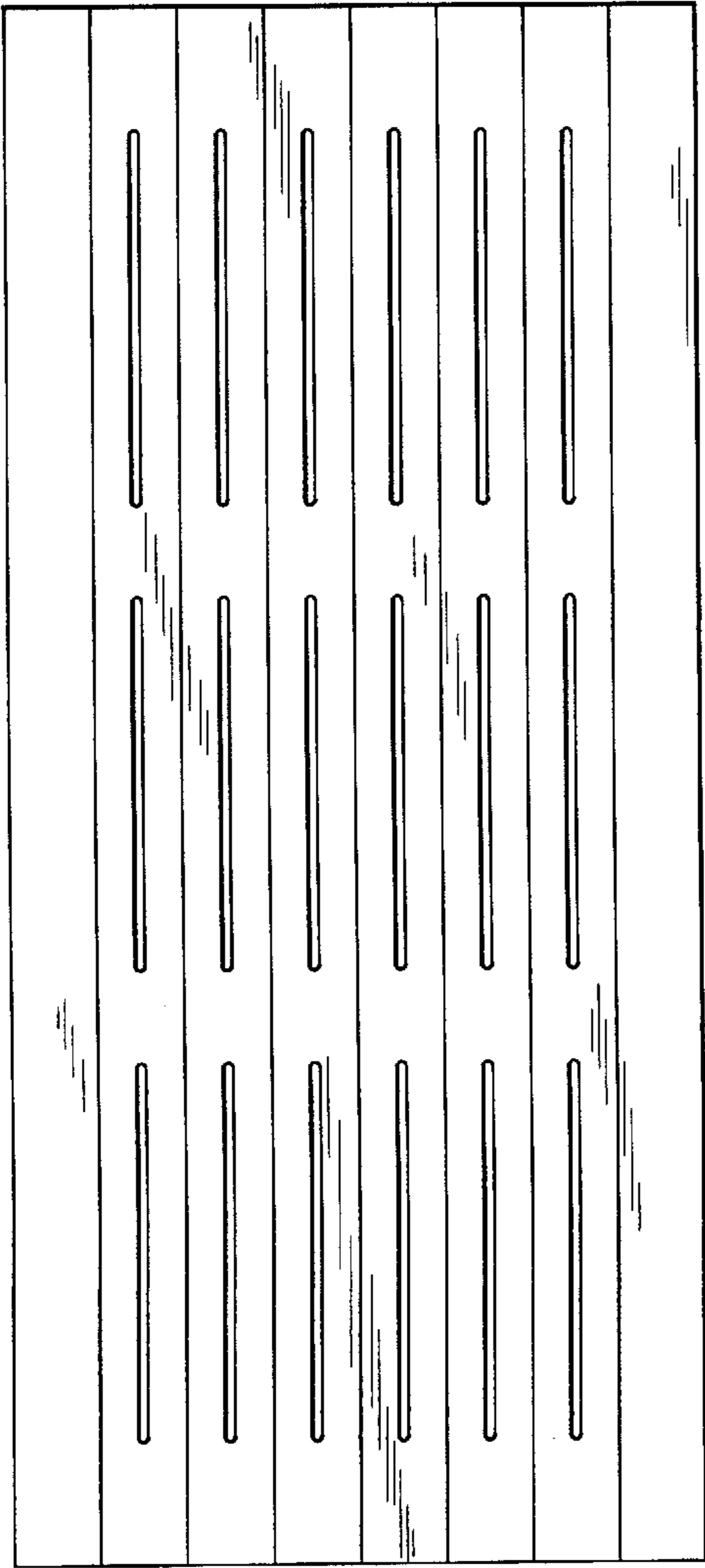

FIG. 7

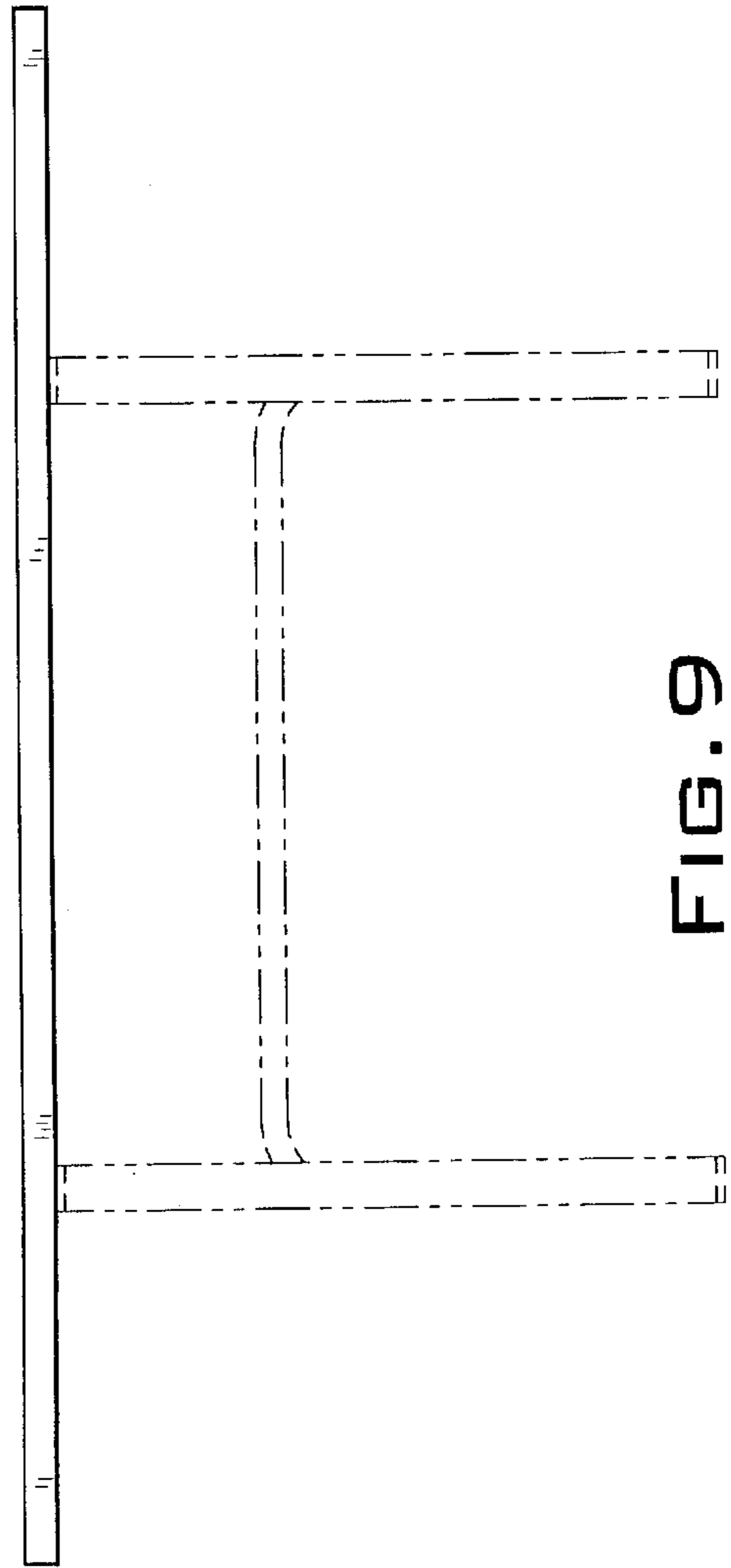

FIG. 9

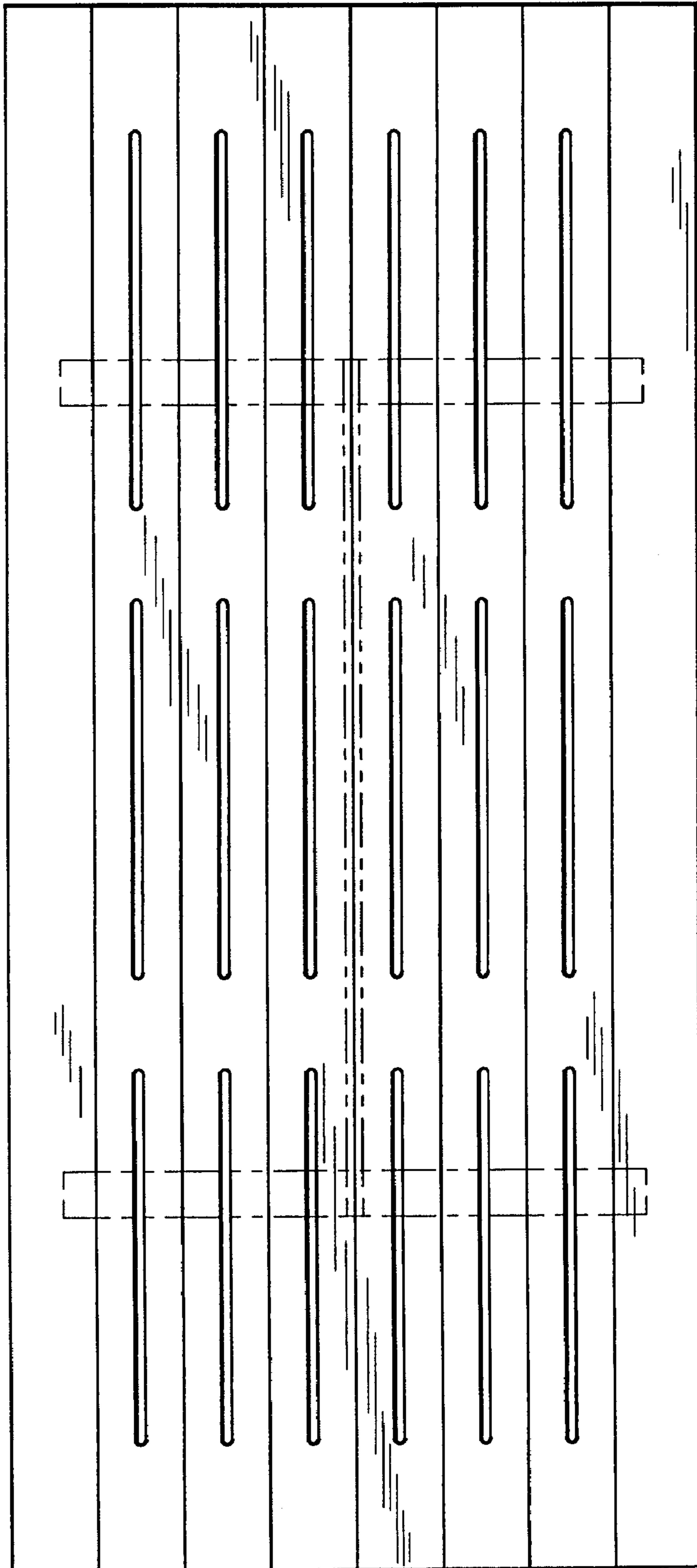

FIG. 10

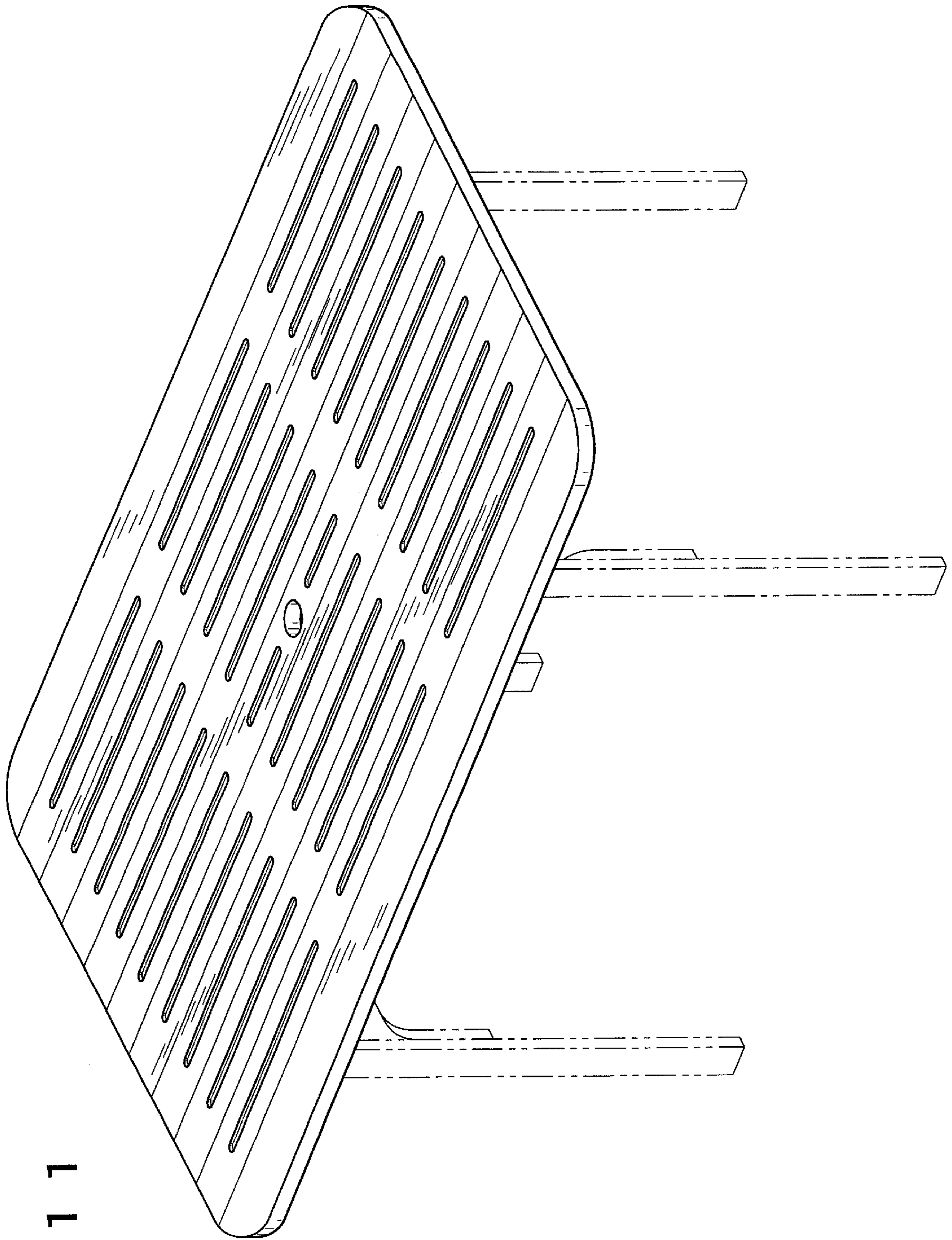

FIG. 1 1

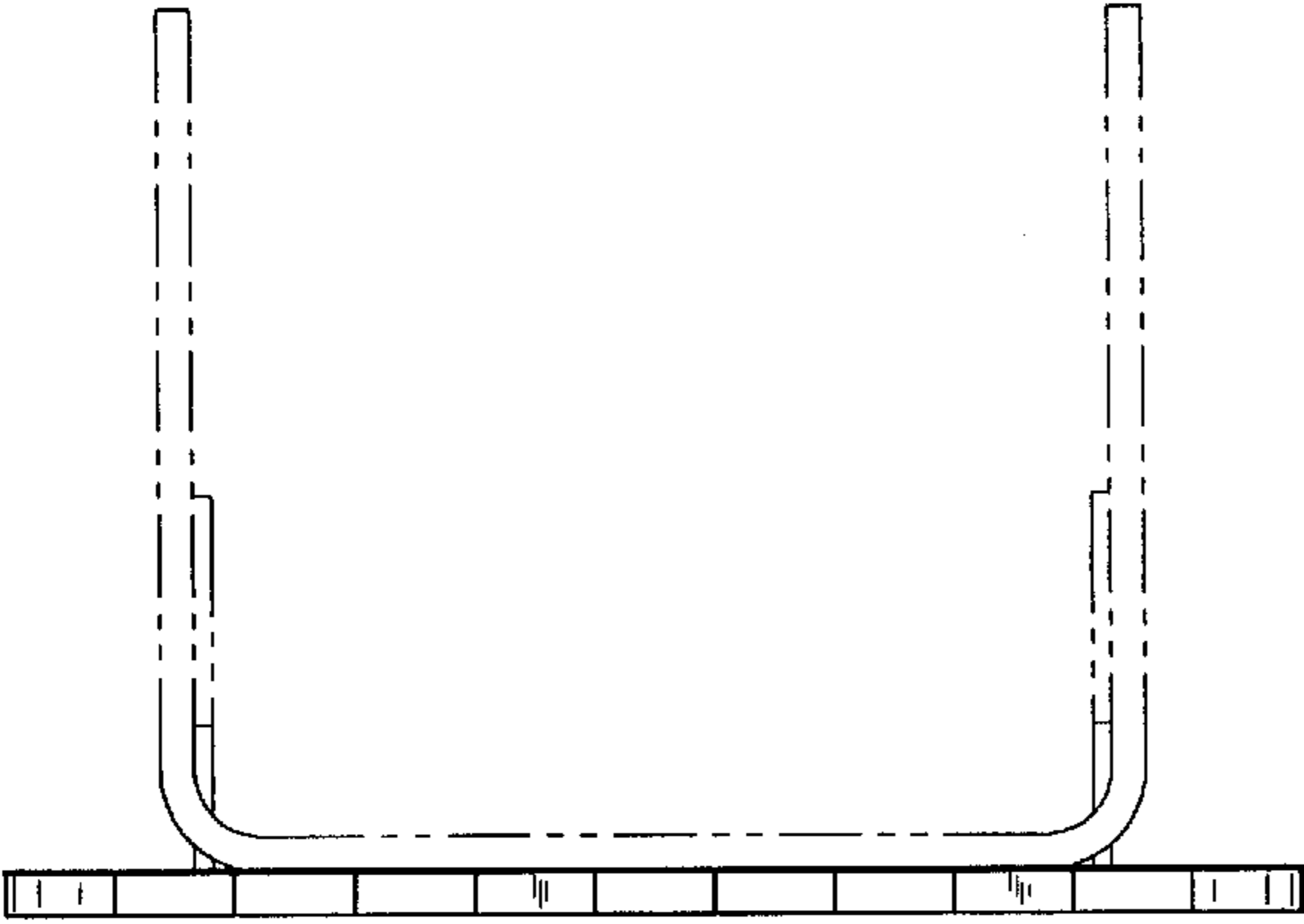

FIG. 13

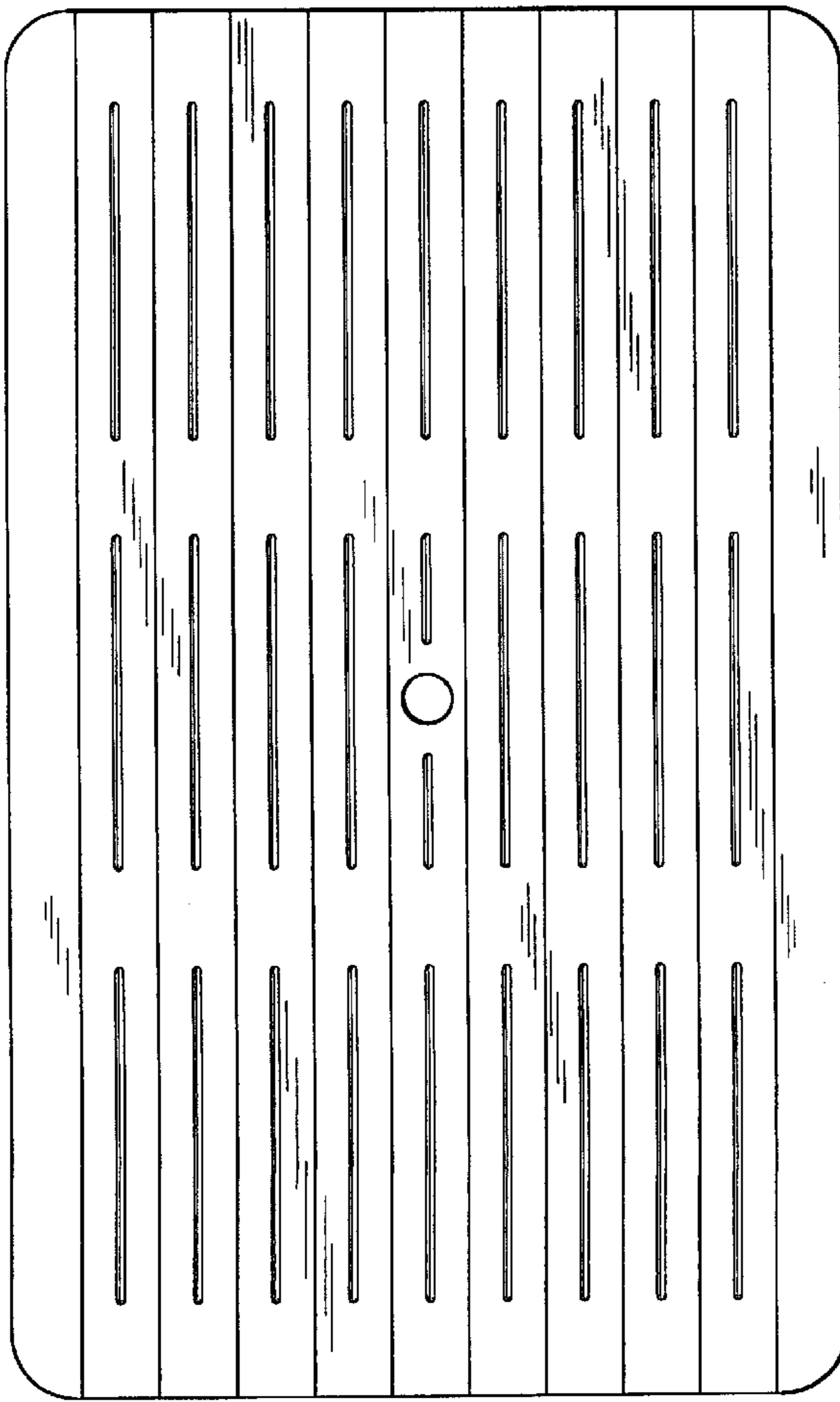

FIG. 12

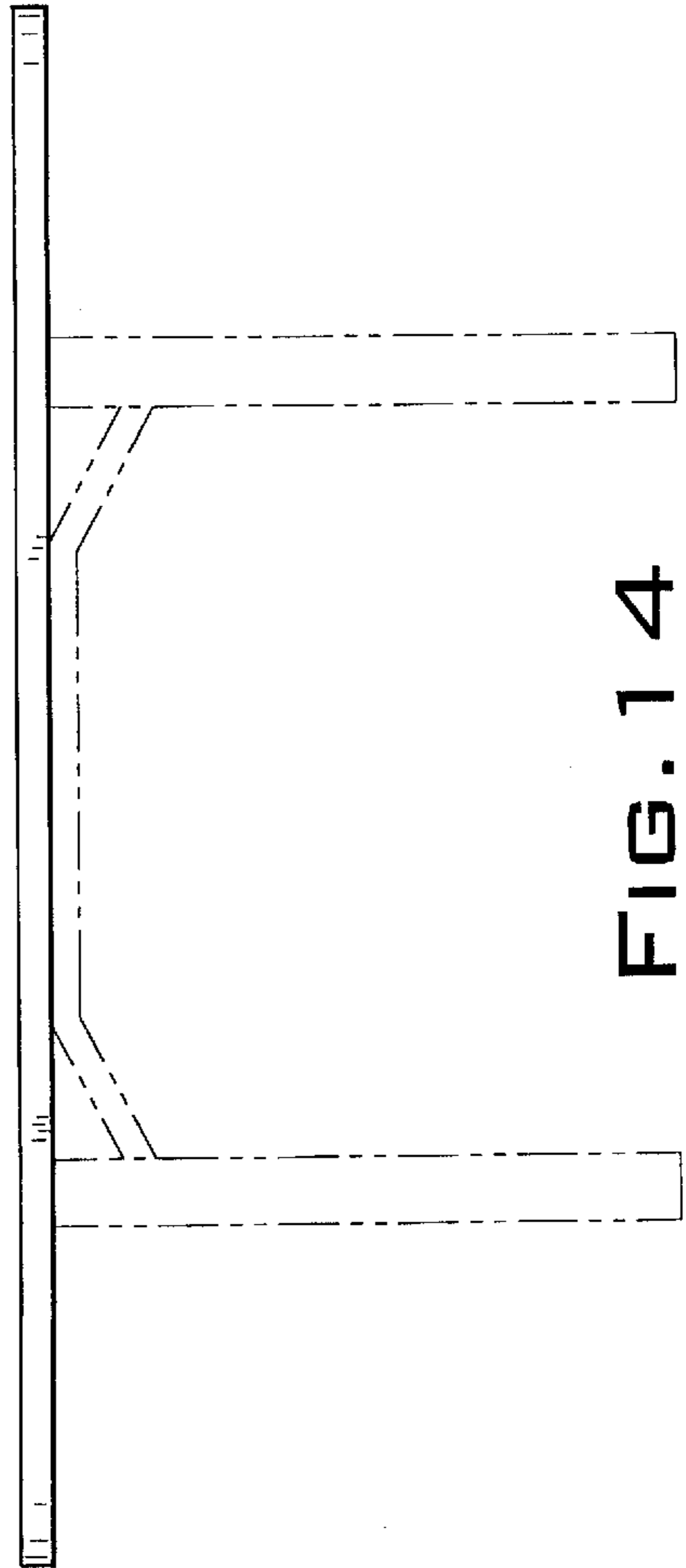

FIG. 14

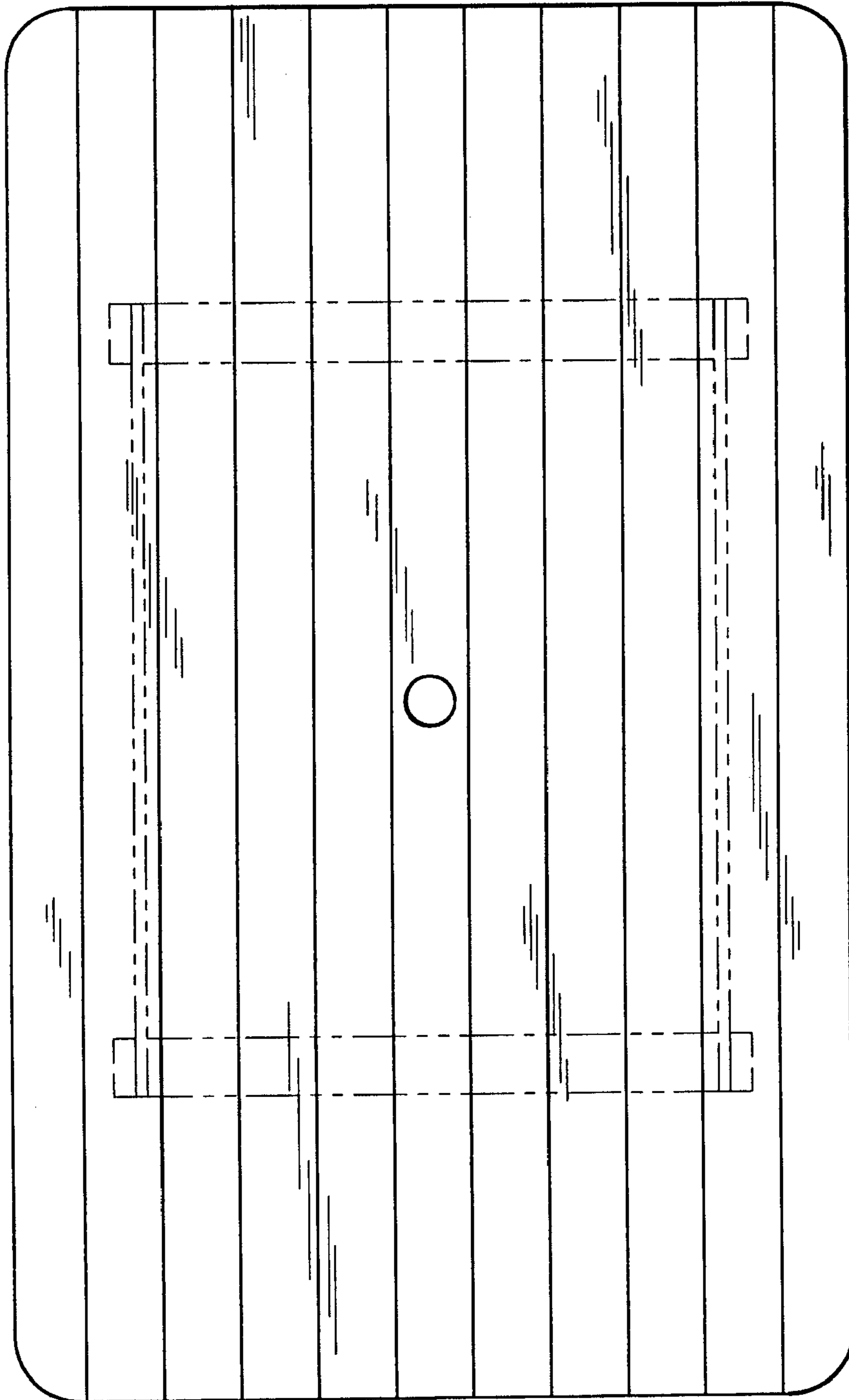

FIG. 15

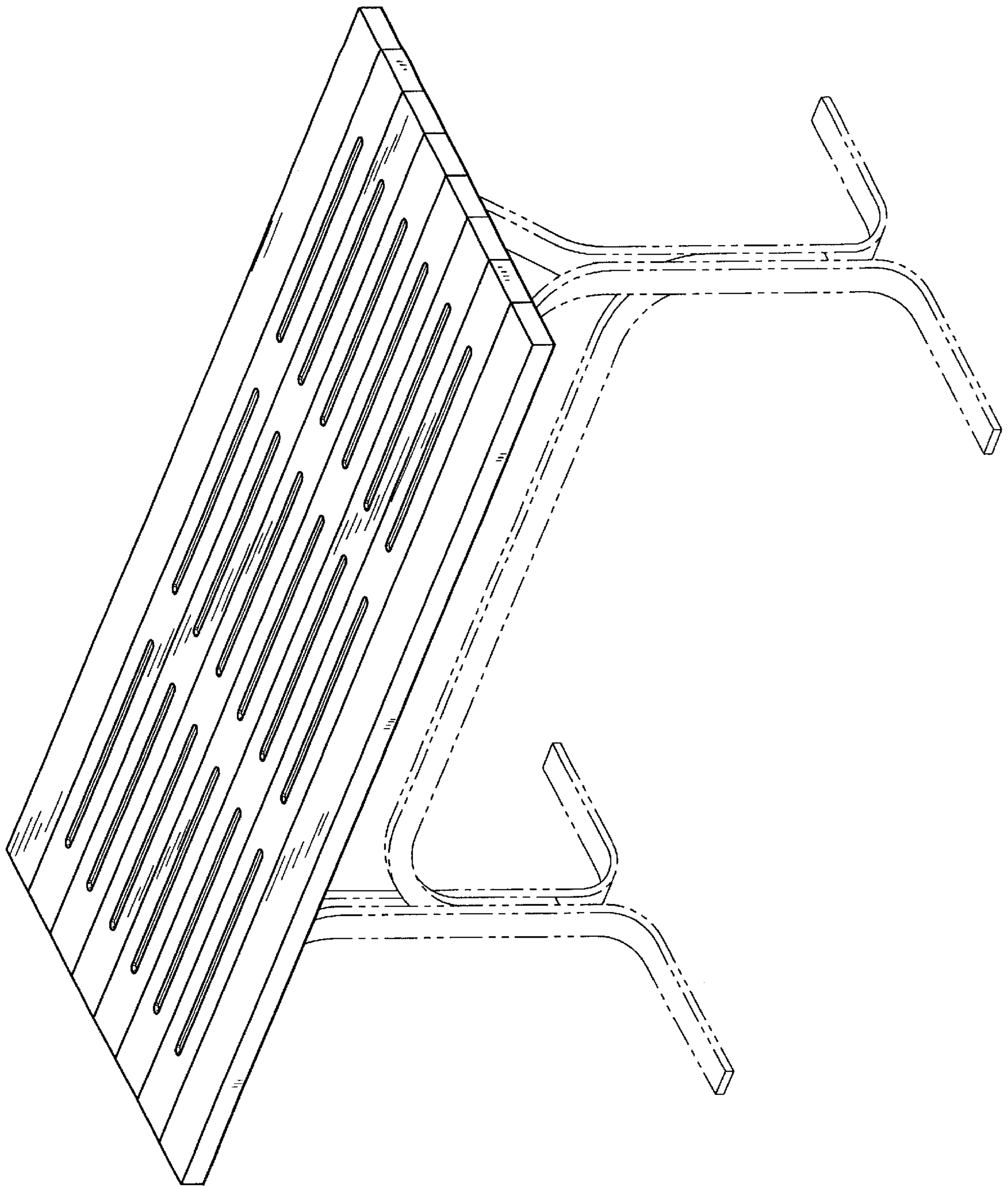

FIG. 16

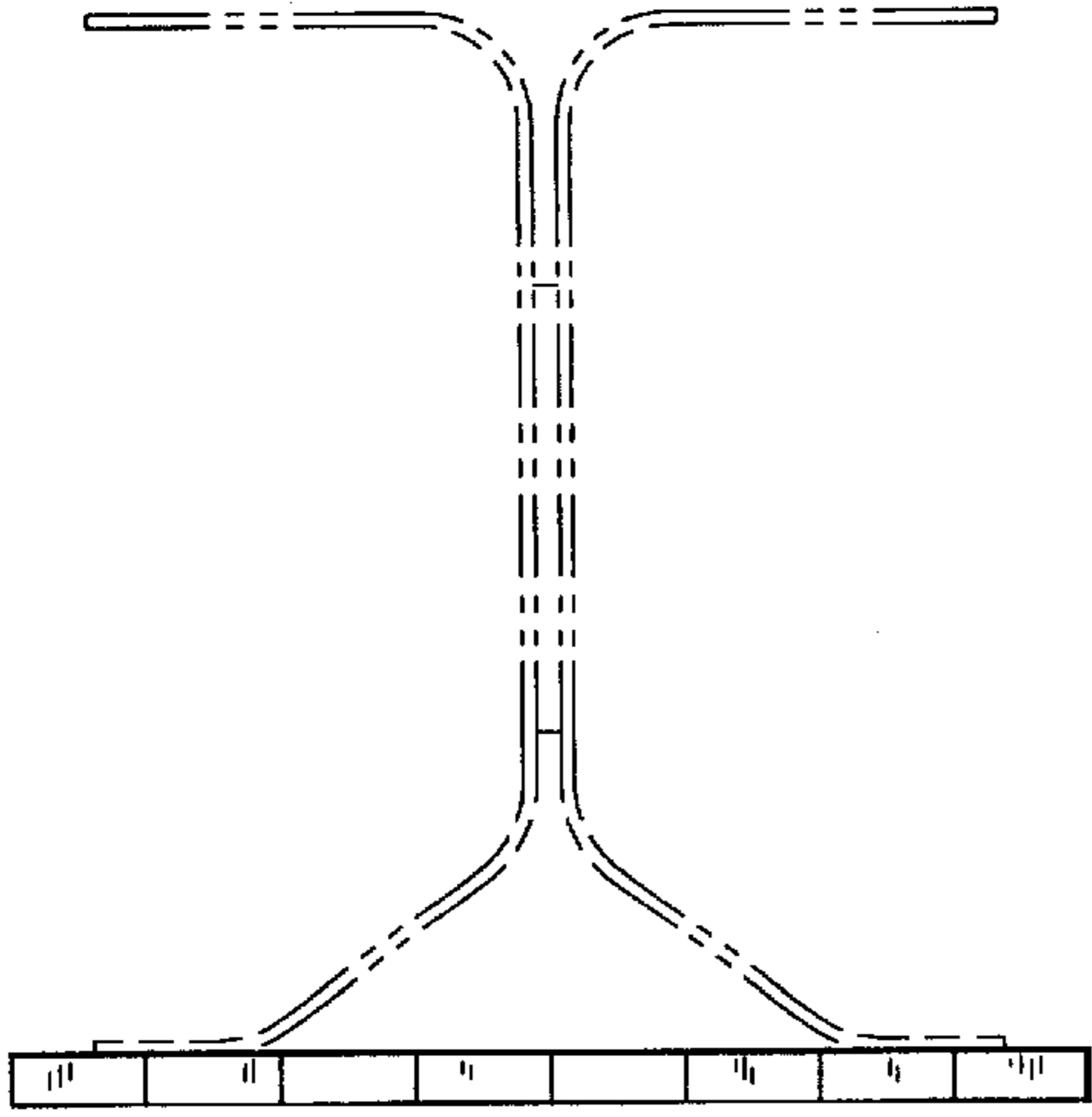

FIG. 18

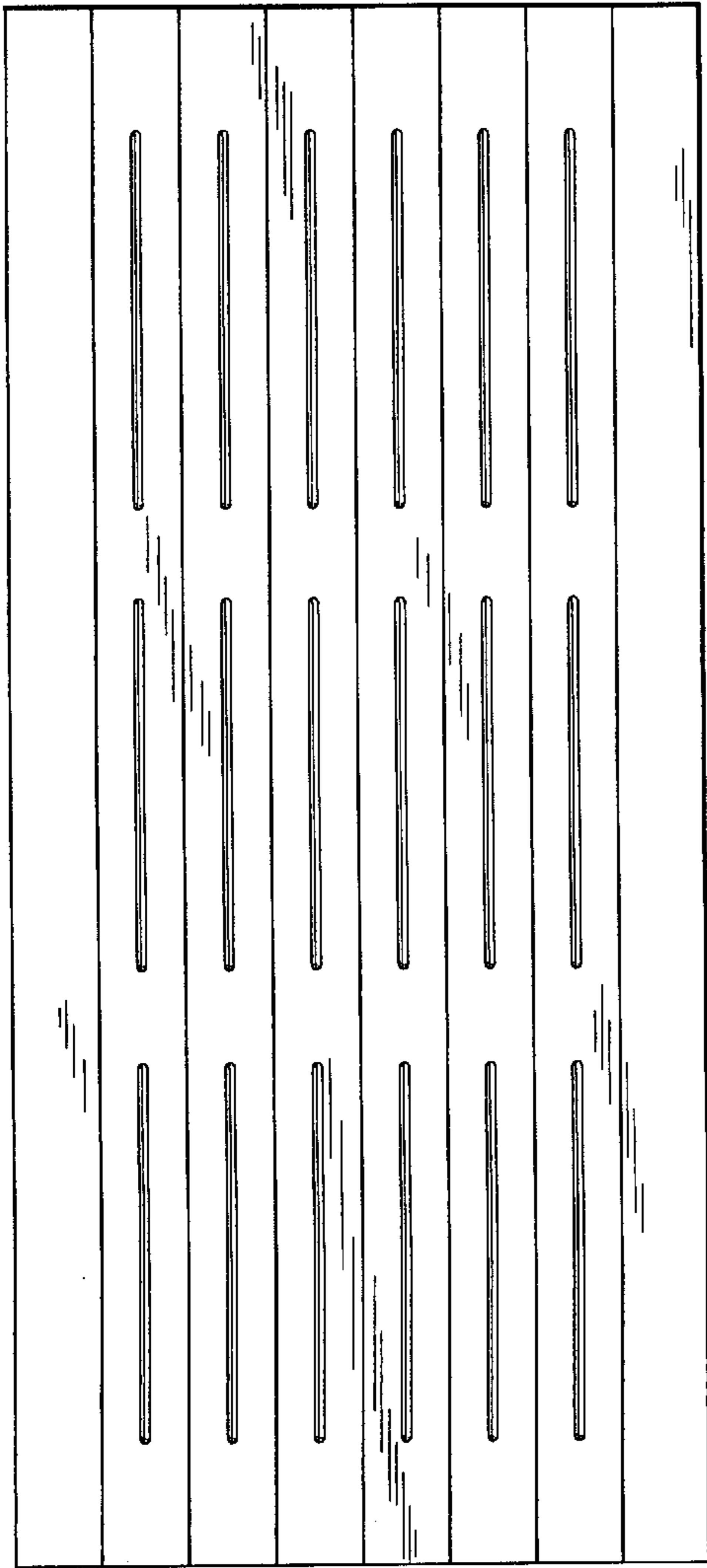

FIG. 17

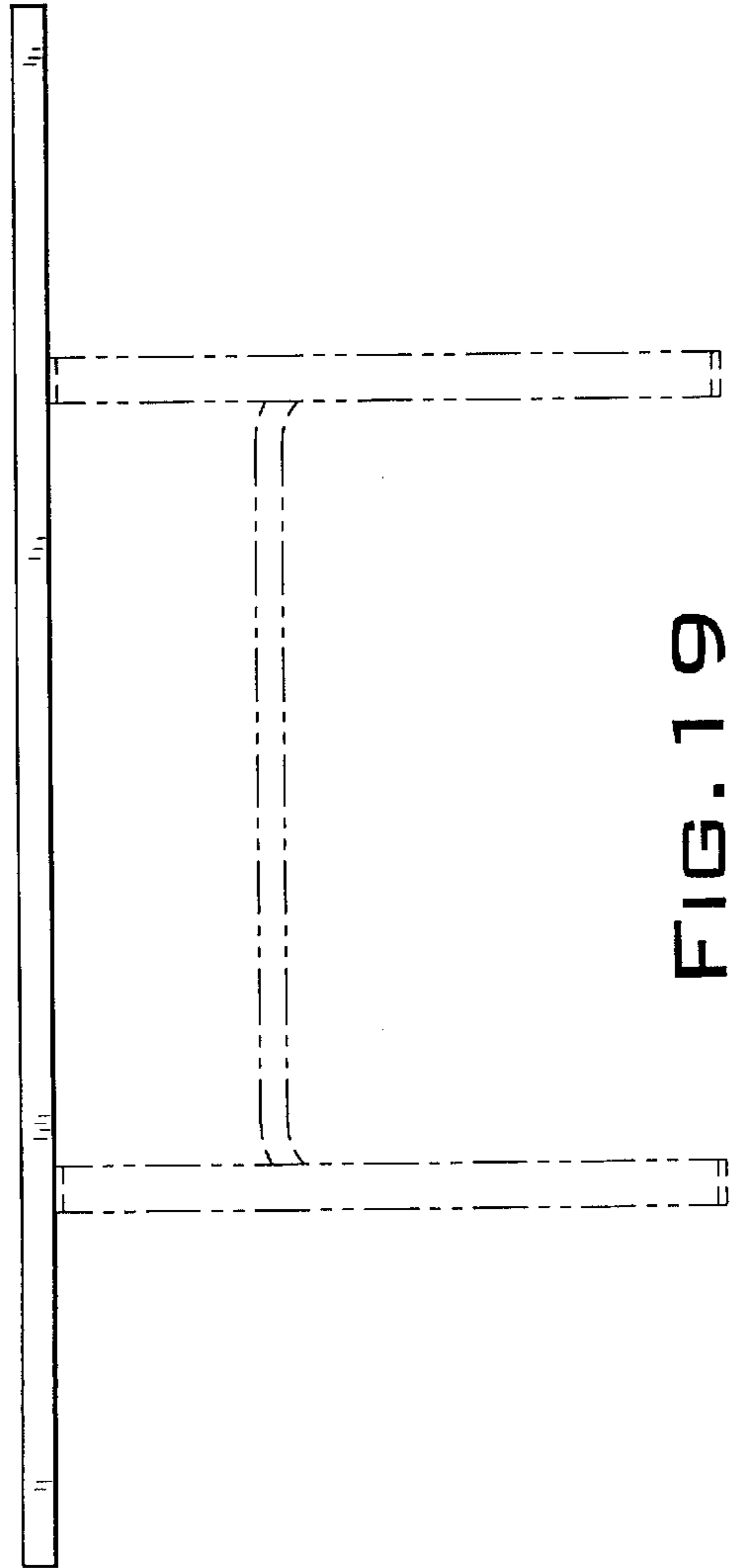

FIG. 19

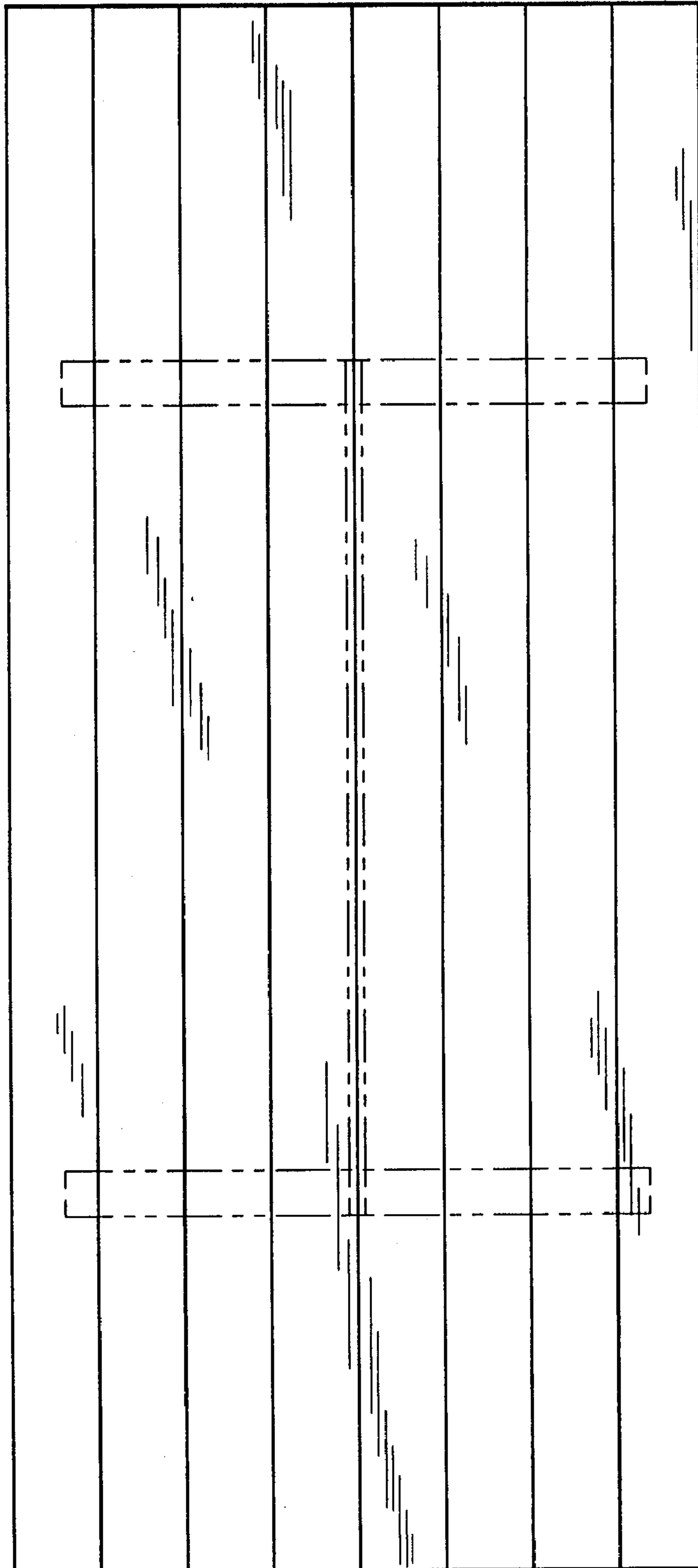

FIG. 20