



US00D446043S

(12) **United States Design Patent**
Stoppenhagen et al.

(10) **Patent No.:** **US D446,043 S**

(45) **Date of Patent:** **** Aug. 7, 2001**

(54) **DISPLAY STAND FOR CONTAINING AND DISPLAYING BULK MERCHANDISE**

(75) Inventors: **Bradley P. Stoppenhagen**, Liberty Township; **Brian Michael Scarth**, Fairfield; **Bryan Lee Thomas**, Cincinnati, all of OH (US)

(73) Assignee: **Campbell Hausfeld/Scott Fetzer Company**, Harrison, OH (US)

(**) Term: **14 Years**

(21) Appl. No.: **29/139,986**

(22) Filed: **Apr. 10, 2001**

Related U.S. Application Data

(62) Division of application No. 29/132,437, filed on Nov. 8, 2000, now Pat. No. Des. 441,561.

(51) **LOC (7) Cl.** **06-99**

(52) **U.S. Cl.** **D6/396**

(58) **Field of Search** D6/396, 397, 405, D6/449, 475, 476, 512; 221/191, 196; 312/42; D7/589, 590

(56) **References Cited**

U.S. PATENT DOCUMENTS

D. 49,875 11/1916 Wearne .

D. 223,586 5/1972 Burden .
D. 297,091 8/1988 Kyler .
D. 317,384 6/1991 Powell .
D. 369,522 5/1996 Casey .
D. 378,887 * 4/1997 Joergensen D7/590
D. 410,157 5/1999 Murray et al. .
1,218,092 3/1917 Levy .

* cited by examiner

Primary Examiner—Nanda Bondade

(74) *Attorney, Agent, or Firm*—Jones, Day, Reavis & Pogue

(57) **CLAIM**

The ornamental design for a display stand for containing and displaying bulk merchandise, as shown and described.

DESCRIPTION

FIG. 1 is a perspective view of a display stand for containing and displaying bulk merchandise showing our new design; FIG. 2 is a top view of the display stand of FIG. 1; FIG. 3 is a bottom view of the display stand of FIG. 1; FIG. 4 is a front view of the display stand of FIG. 1; FIG. 5 is a rear view of the display stand of FIG. 1; FIG. 6 is a side view of the display stand of FIG. 1; and, FIG. 7 is an opposite side view of the display stand of FIG. 1.

1 Claim, 2 Drawing Sheets

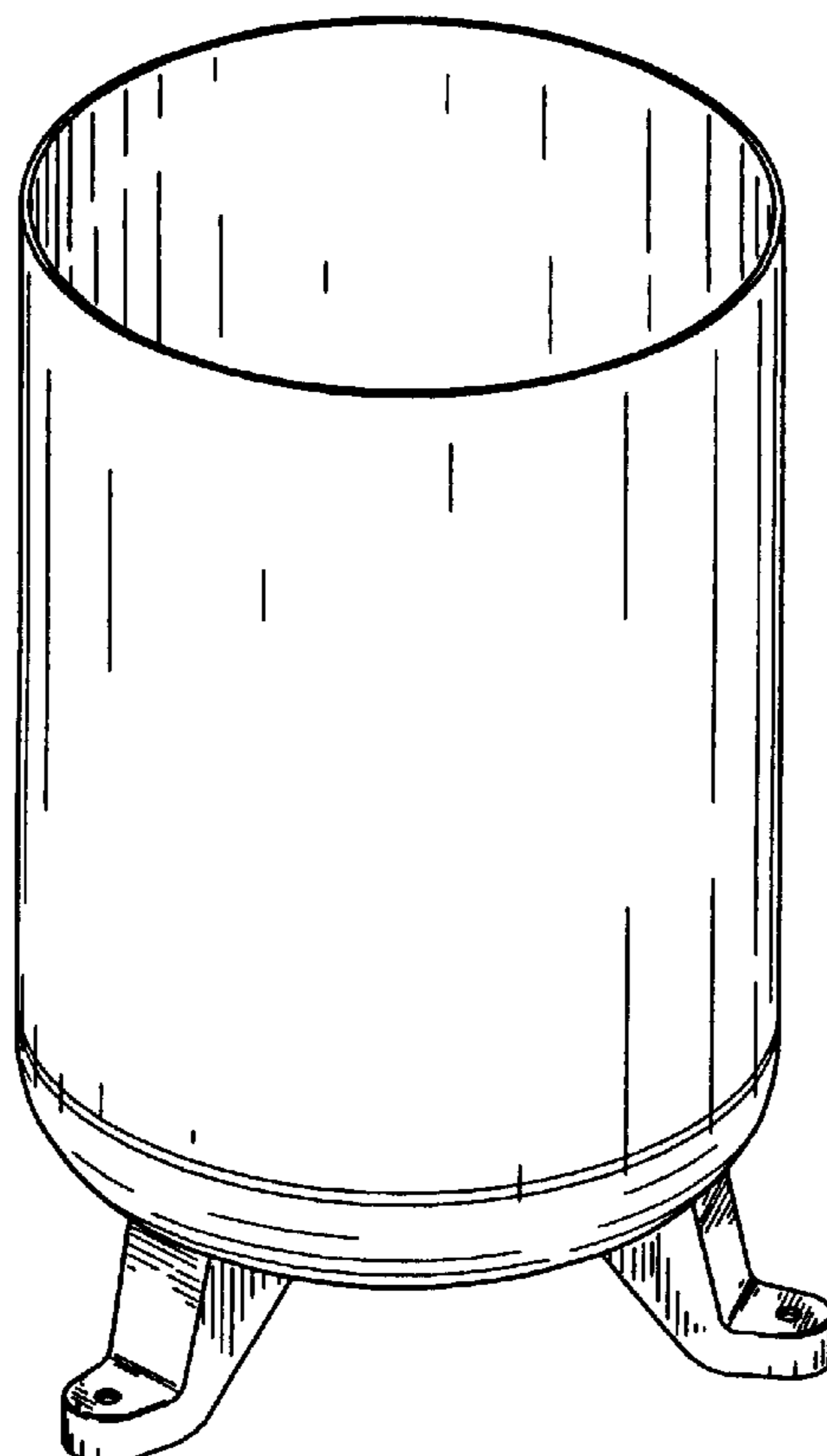

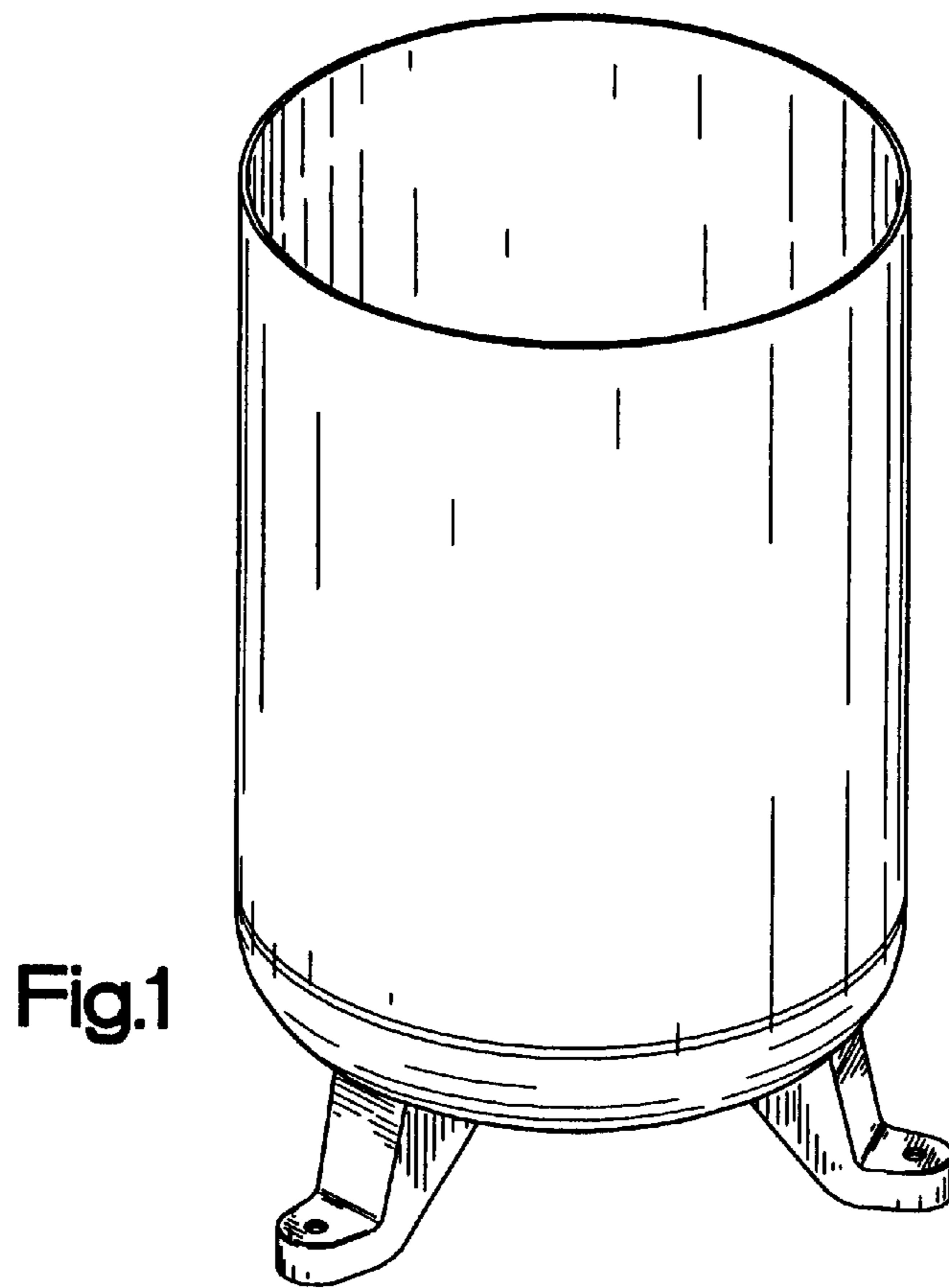

Fig.1

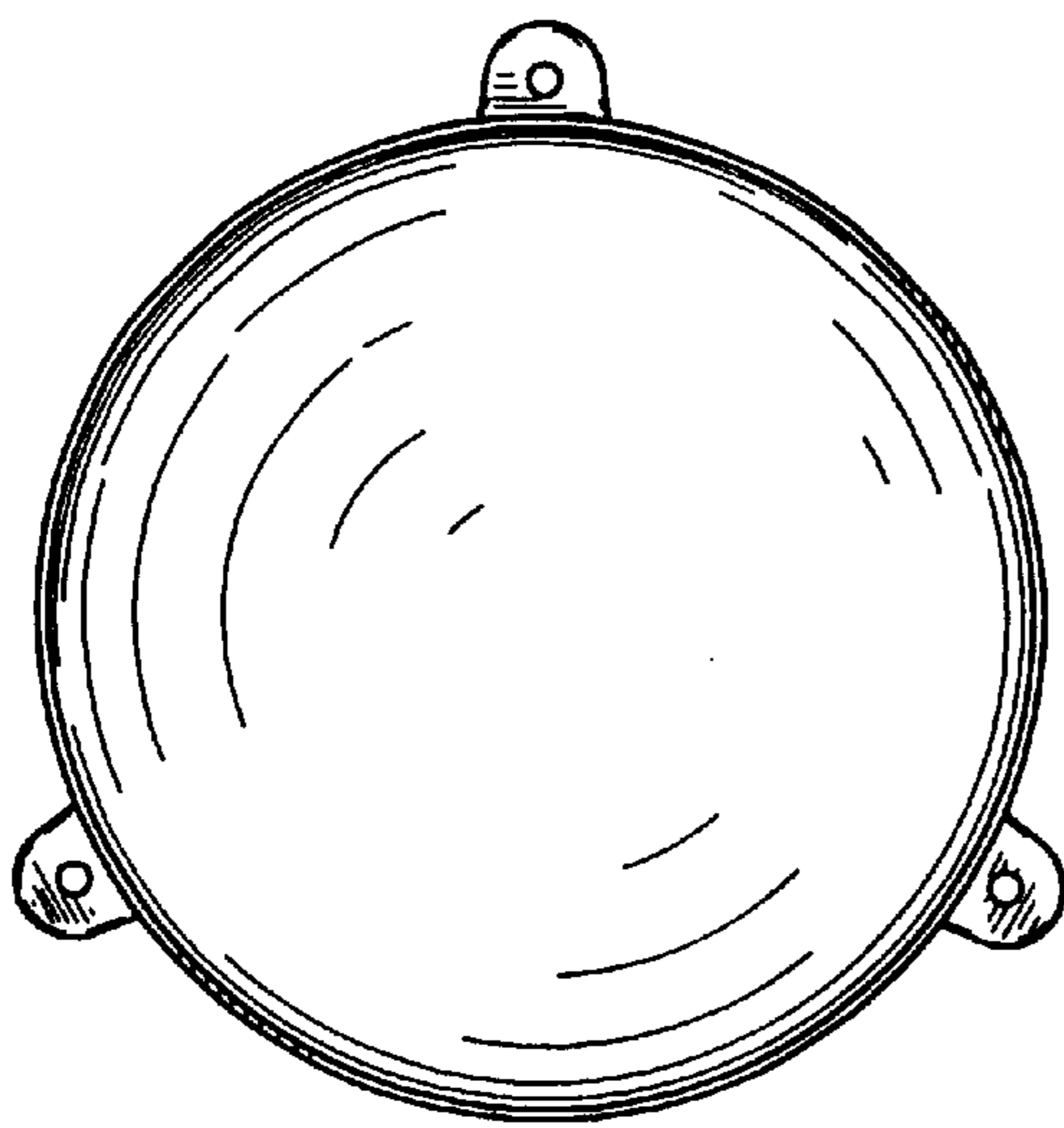

Fig.2

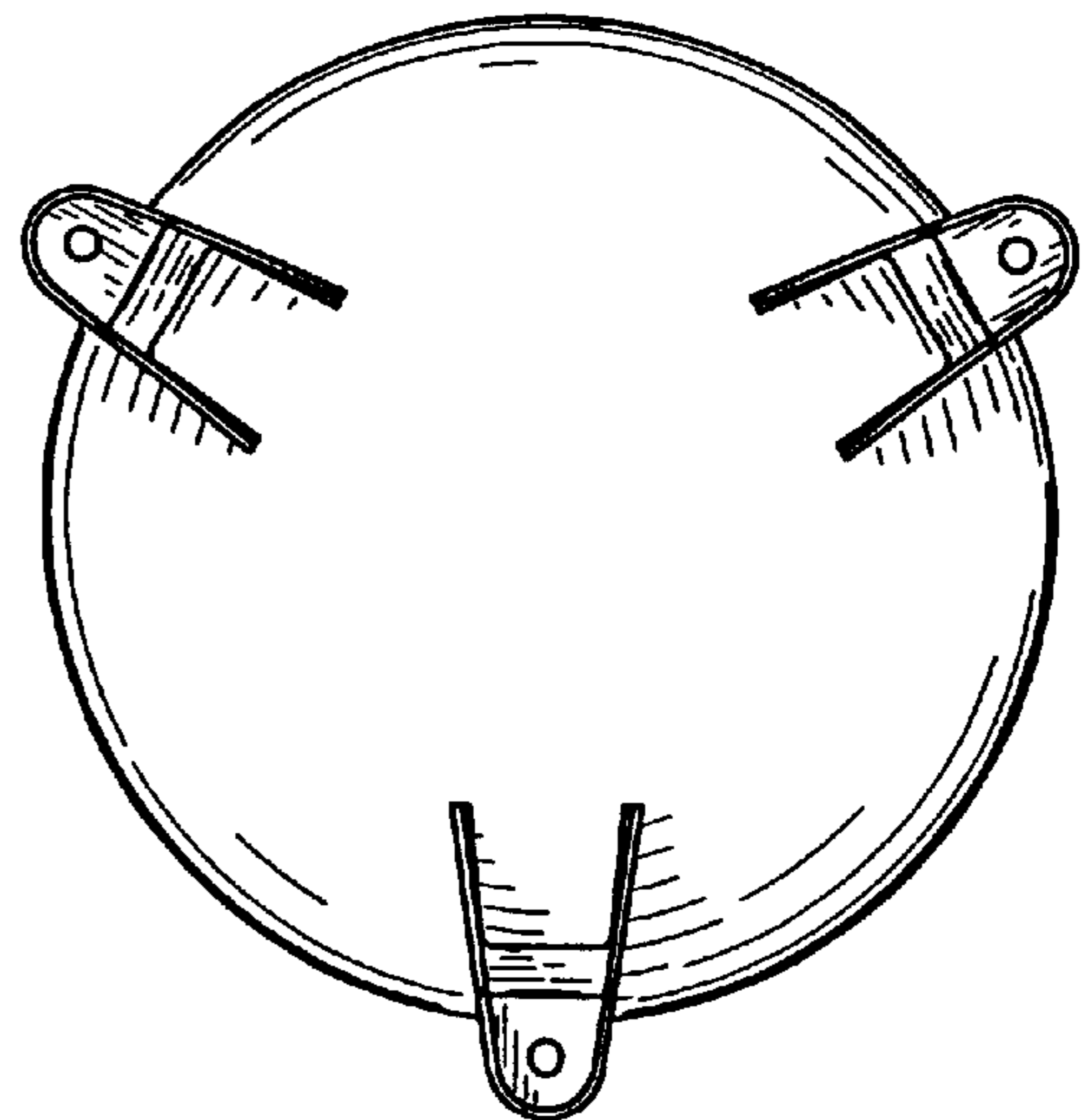

Fig.3

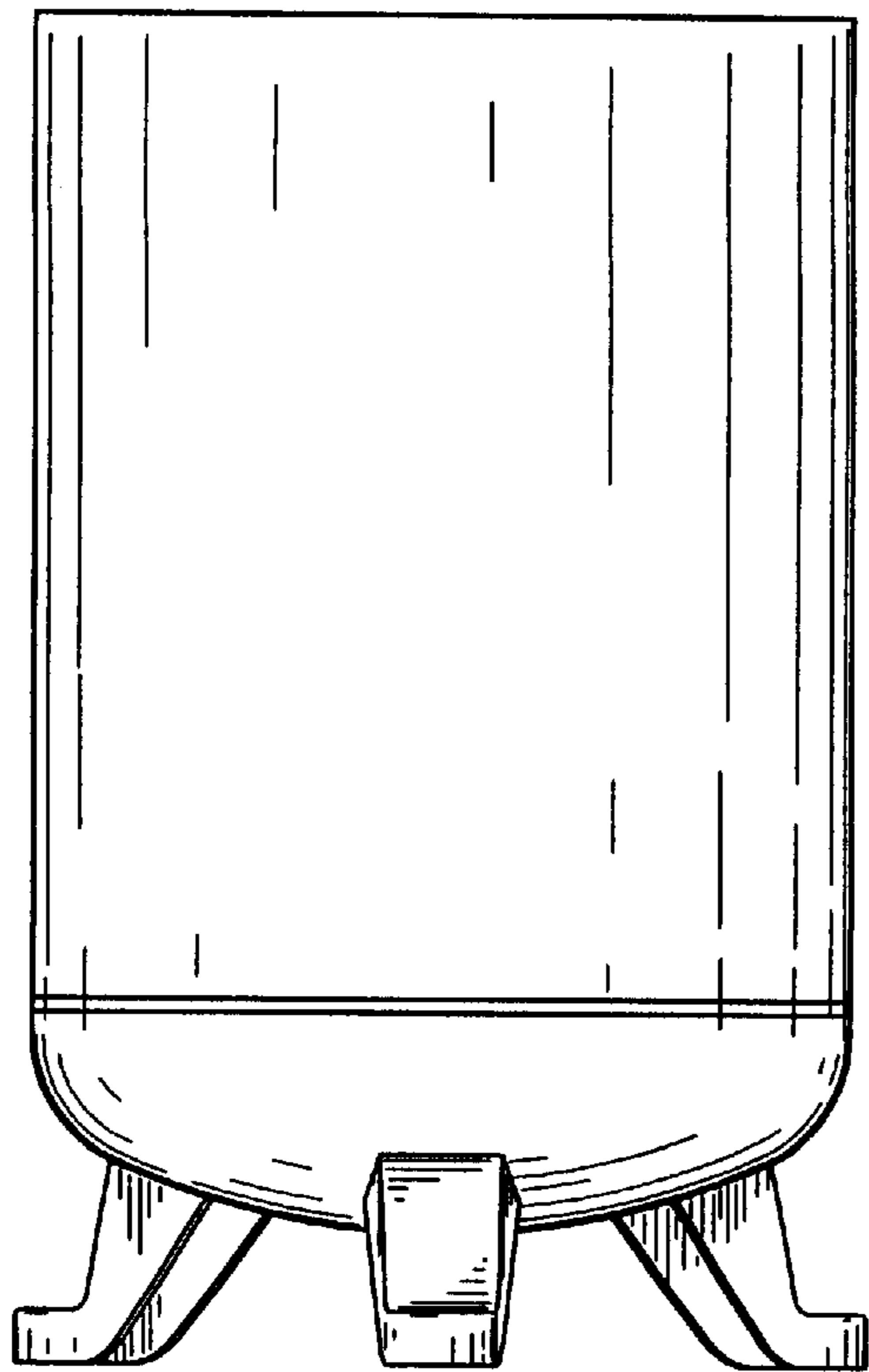

Fig.4

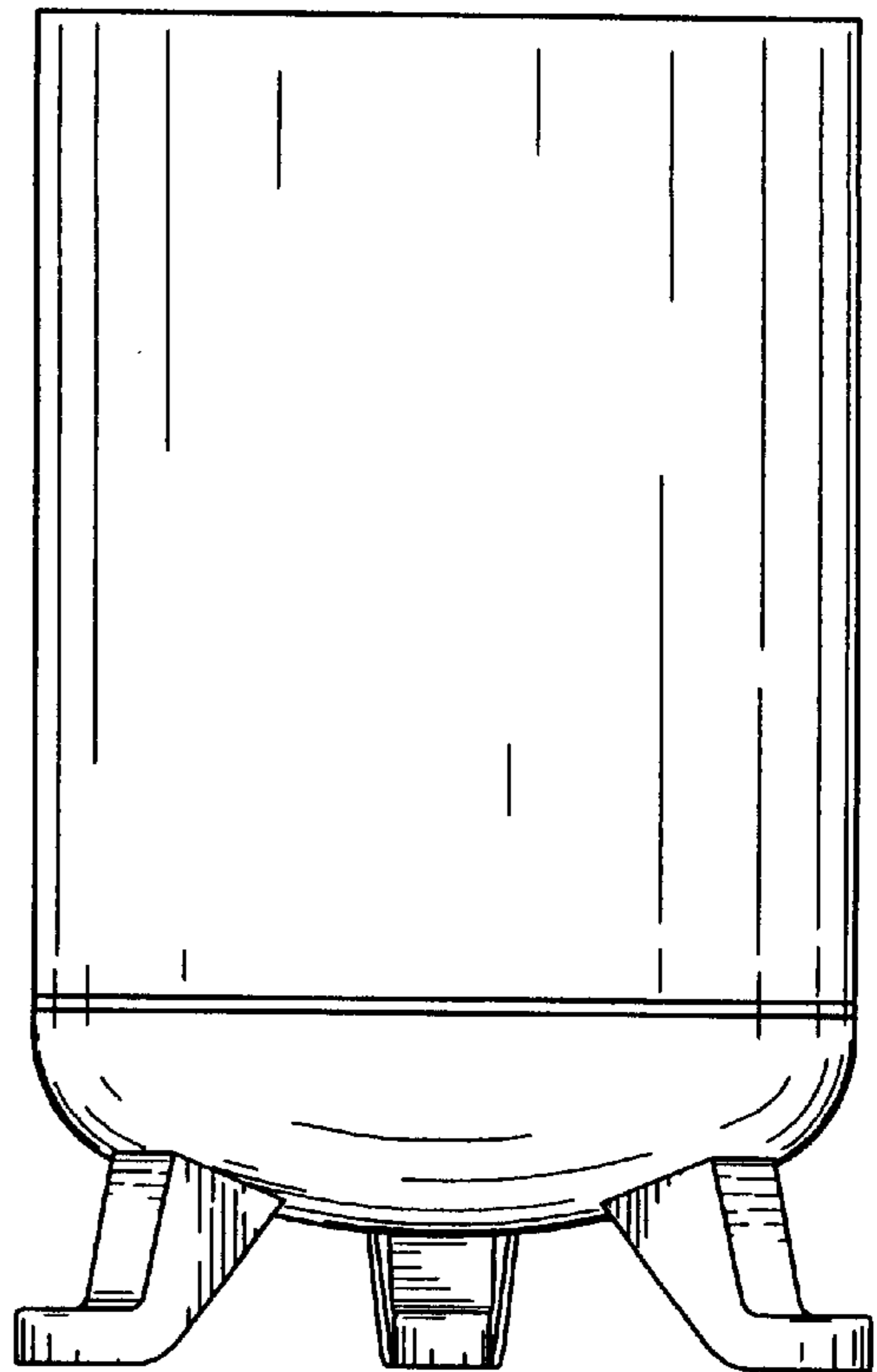

Fig.5

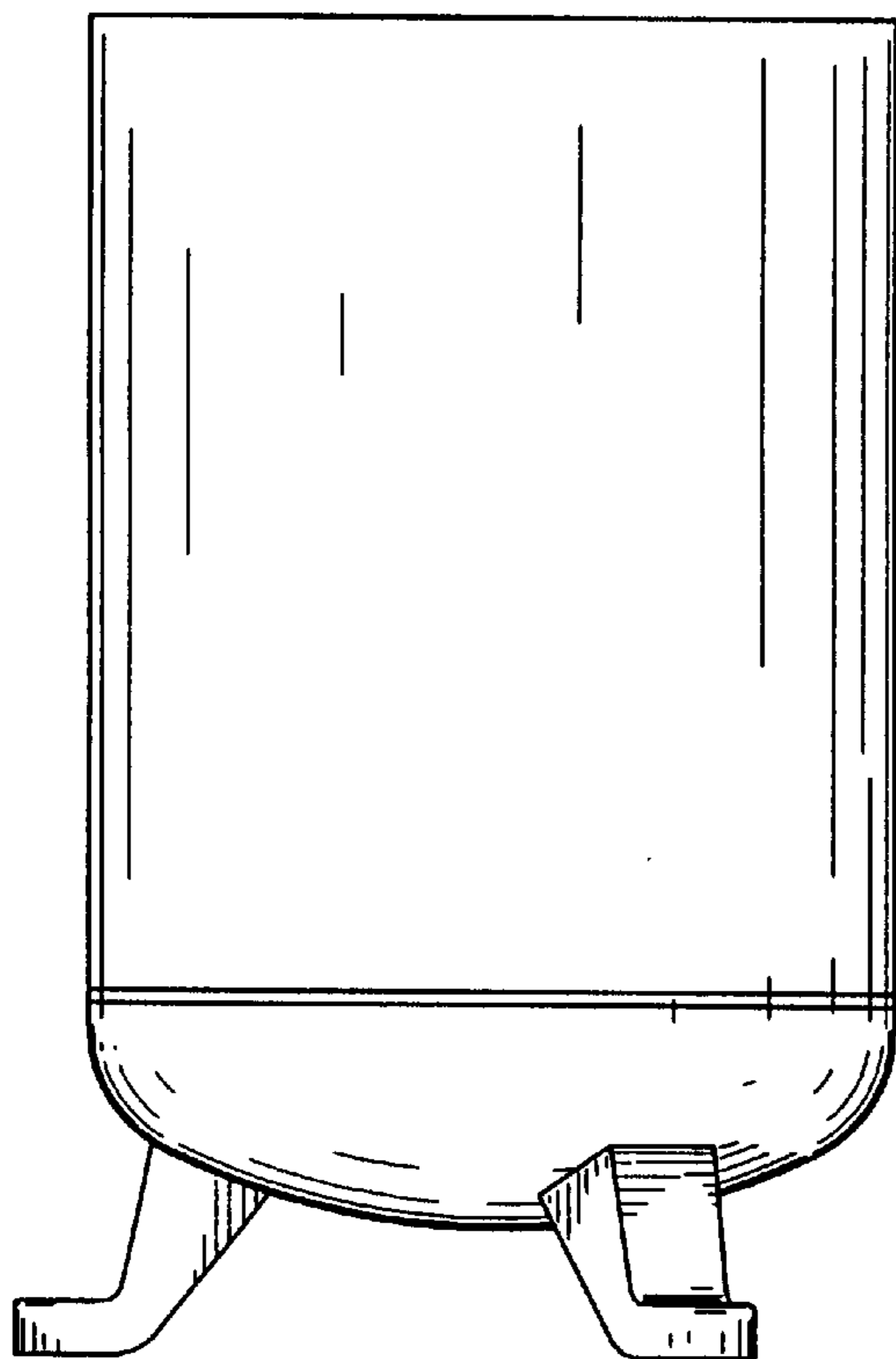

Fig.6

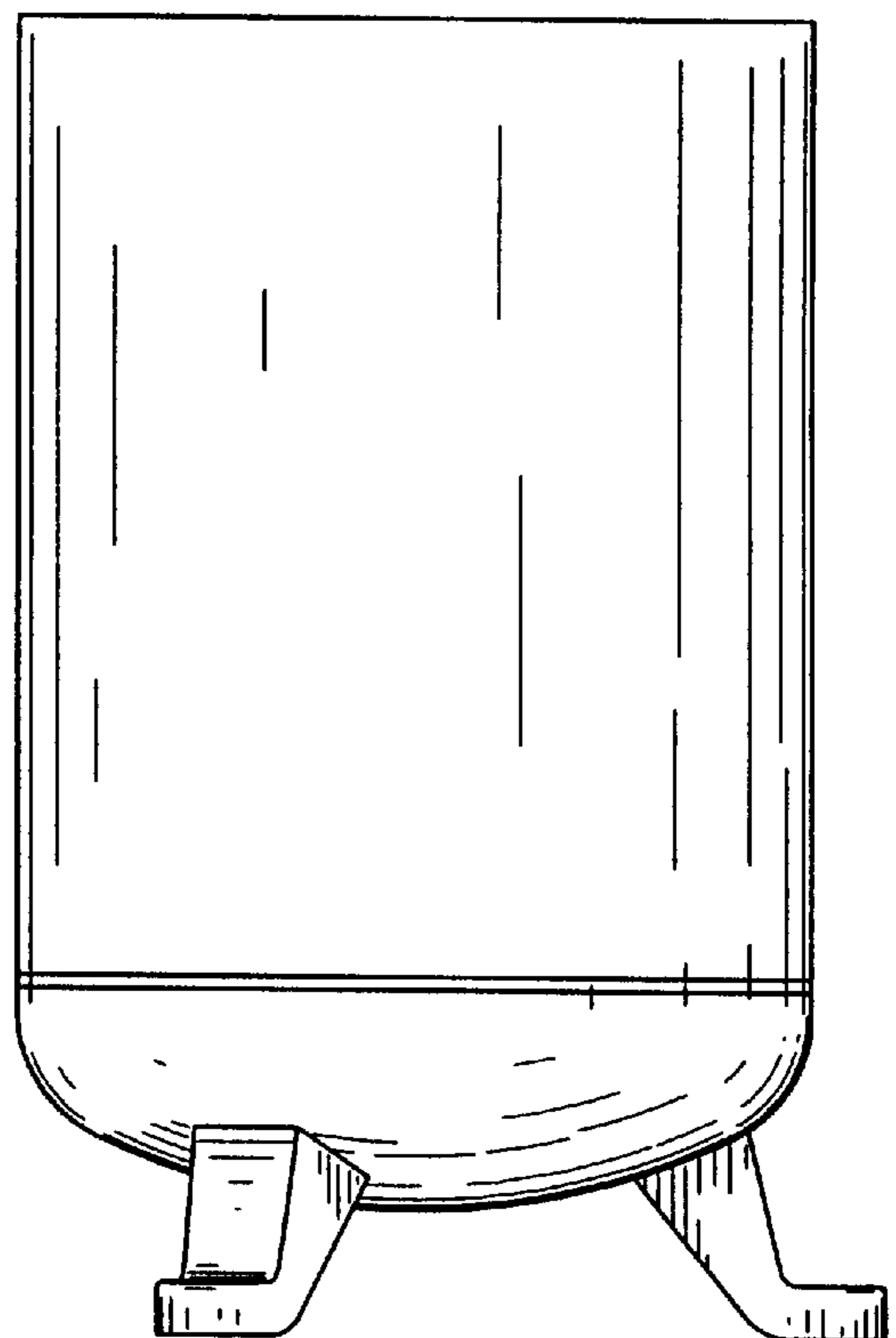

Fig.7