



US00D445977S

(12) **United States Design Patent**
Paterson et al.

(10) **Patent No.:** **US D445,977 S**

(45) **Date of Patent:** **** Jul. 31, 2001**

(54) **BAG FOR FLOOR CARE APPARATUS**

(75) Inventors: **Chris M. Paterson**, Long Beach, LA
(US); **Javier Verdura**, Milford, CT
(US)

(73) Assignee: **Oreck Holdings, LLC**, Cheyenne, WY
(US)

(**) Term: **14 Years**

(21) Appl. No.: **29/125,840**

(22) Filed: **Jun. 30, 2000**

(51) **LOC (7) Cl.** **15-05**

(52) **U.S. Cl.** **D32/31**

(58) **Field of Search** D32/31, 34, 25,
D32/22, 30; 15/347, 350-352; 55/334,
361, 371-372, 380-381

(56) **References Cited**

U.S. PATENT DOCUMENTS

- D. 213,586 * 3/1969 Howard et al. D32/31
- D. 292,335 * 10/1987 Wareham et al. D32/22
- D. 313,681 * 1/1991 McKnight D32/22
- D. 338,295 * 8/1993 Kieft D32/31
- D. 343,033 * 1/1994 Shoji D32/22

- D. 346,052 * 4/1994 Saunders et al. D32/22
- D. 426,688 * 6/2000 Moine et al. D32/31
- D. 429,041 * 8/2000 Medema et al. D32/22
- 4,715,084 * 12/1987 Jacob et al. 15/328
- 4,720,887 * 1/1988 Bosyj et al. 15/351
- 5,306,534 * 4/1994 Bosses 428/35.2

* cited by examiner

Primary Examiner—Ruth McInroy

(74) *Attorney, Agent, or Firm*—Dorsey & Whitney LLP

(57) **CLAIM**

The ornamental design for a bag for floor care apparatus, as shown and described.

DESCRIPTION

FIG. 1 is a front, right isometric view of a bag for floor care apparatus showing our new design; FIG. 2 is a front elevation view thereof; FIG. 3 is a rear elevation view thereof; FIG. 4 is a top plan view thereof; and, FIG. 5 is a right side elevational view thereof.

Portions of the accompanying drawings that appear in phantom lines are provided to illustrate the environment of the invention and do not form part of the invention as claimed.

1 Claim, 3 Drawing Sheets

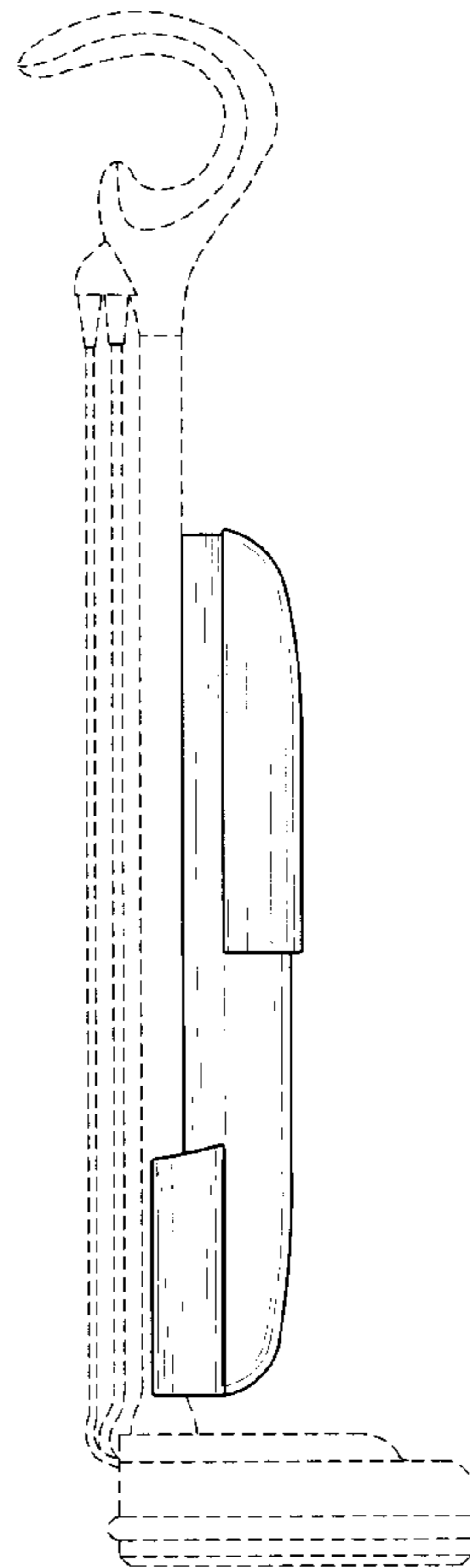
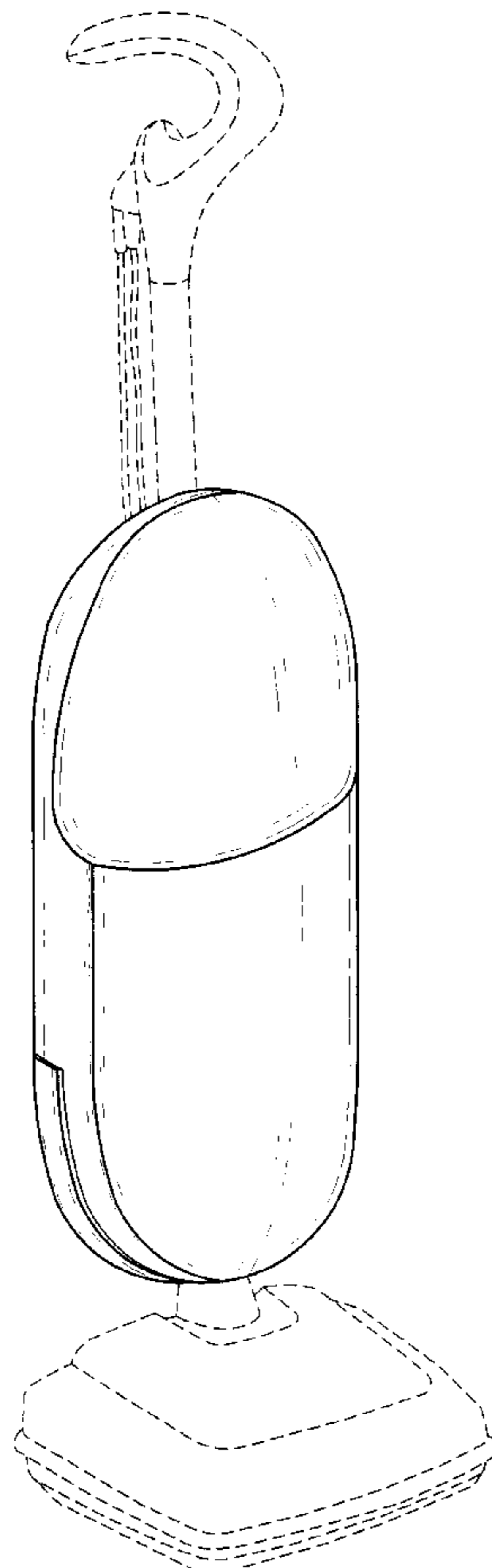

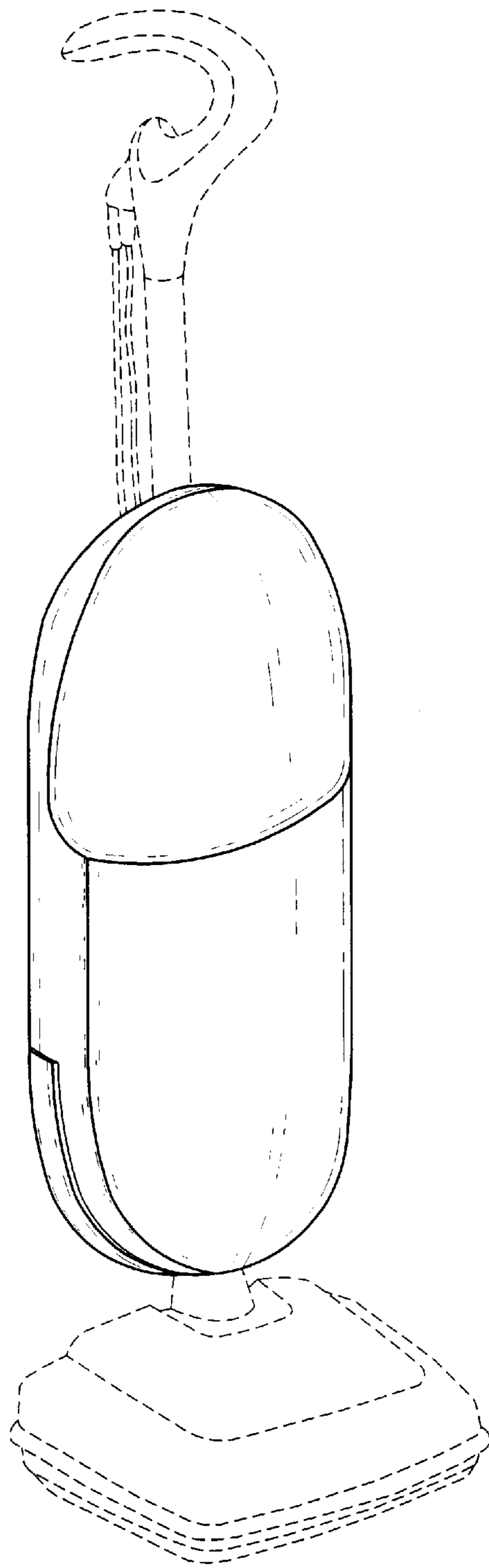

Fig. 1

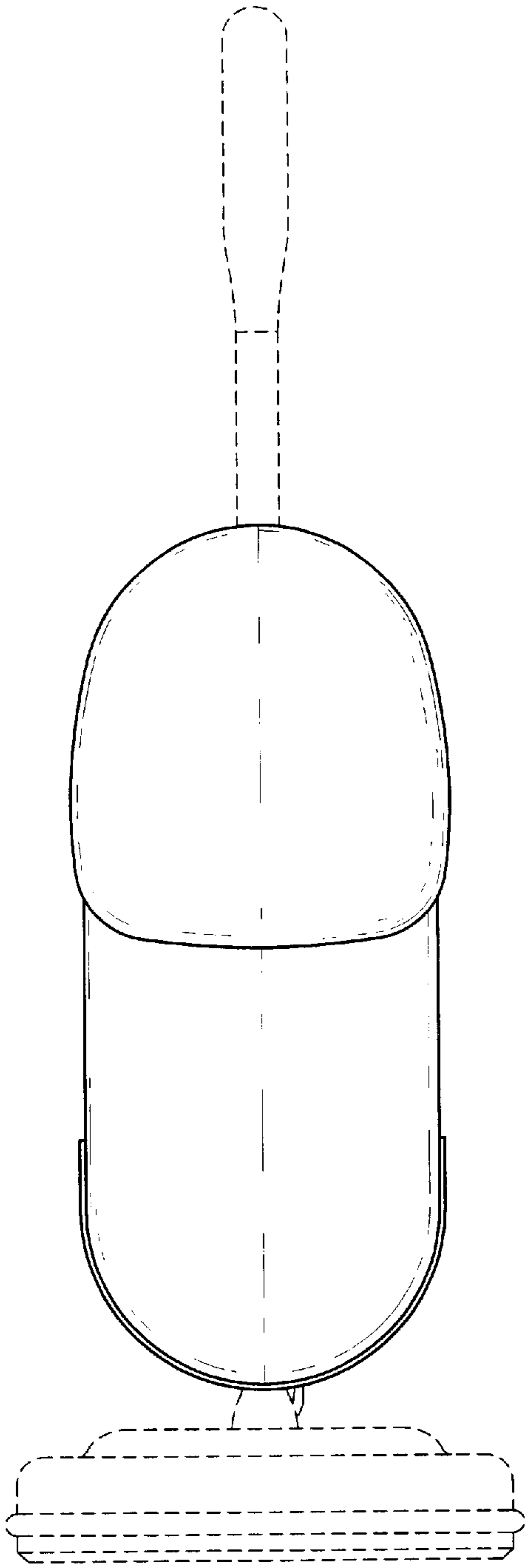

Fig. 2

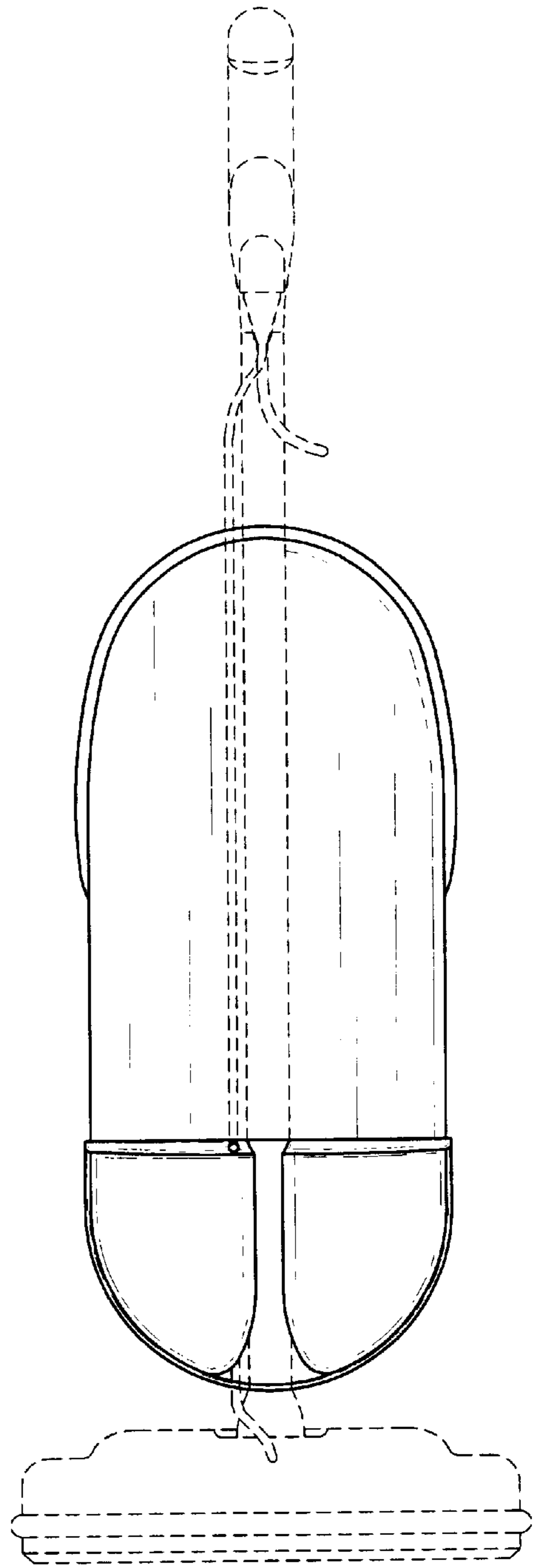

Fig. 3

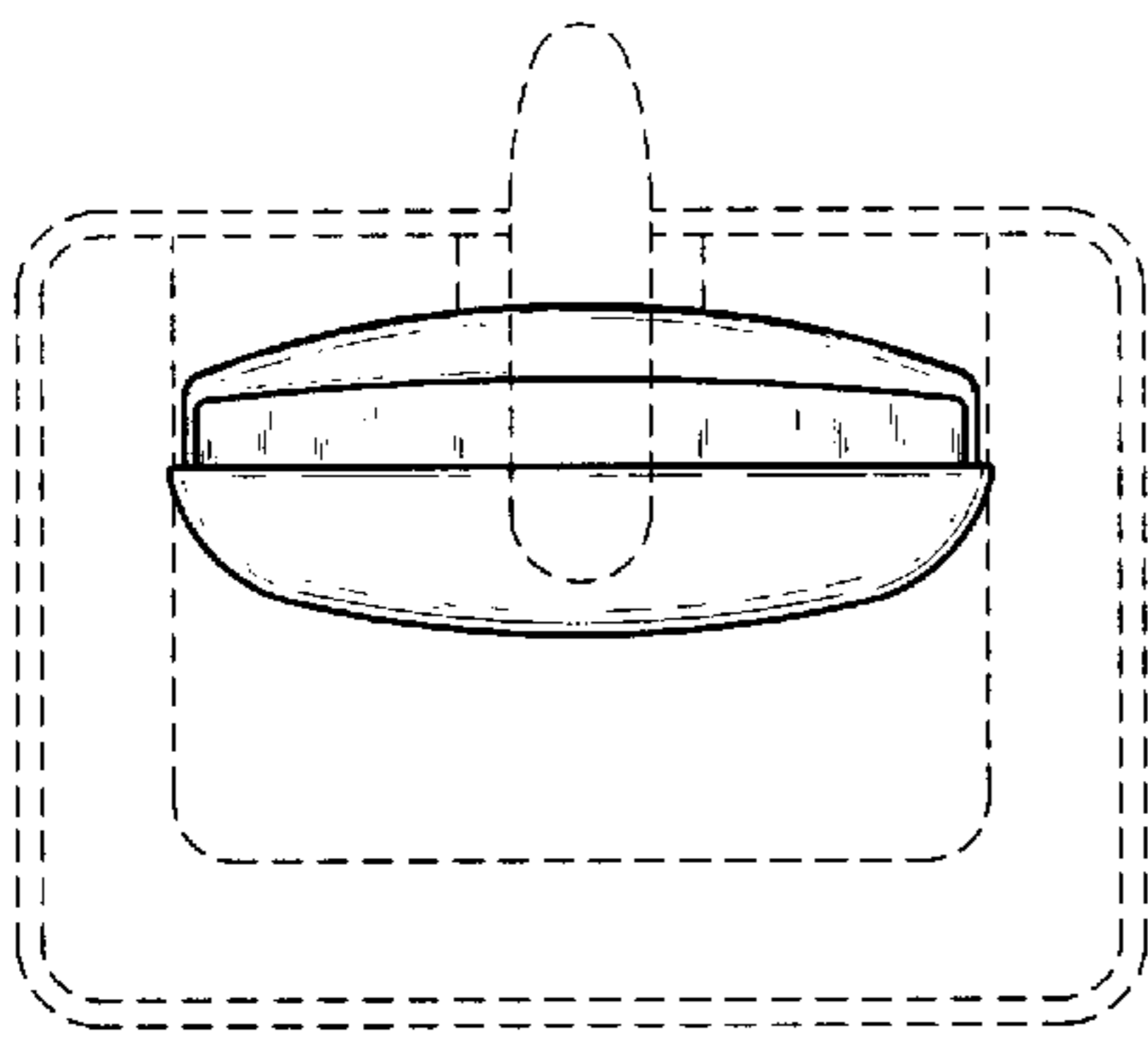

Fig. 4

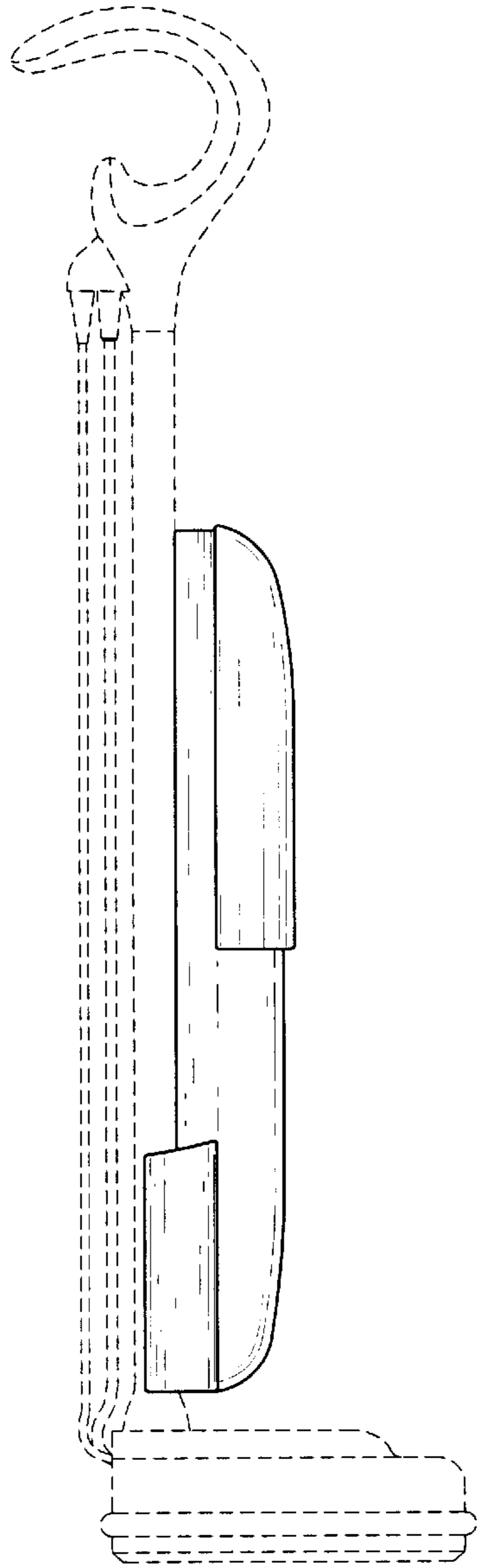

Fig. 5

UNITED STATES PATENT AND TRADEMARK OFFICE
CERTIFICATE OF CORRECTION

PATENT NO. : Des. 445,977 S
DATED : July 31, 2001
INVENTOR(S) : Chris M. Paterson and Javier Verdura

Page 1 of 1

It is certified that error appears in the above-identified patent and that said Letters Patent is hereby corrected as shown below:

Title page,

Item [75], Inventors, replace “**Chris M. Paterson, Long Beach, LA**” with
-- **Chris M. Paterson, Long Beach, MS** --

Signed and Sealed this

Sixteenth Day of December, 2003

A handwritten signature in black ink, appearing to read "James E. Rogan", with a horizontal line underneath it.

JAMES E. ROGAN
Director of the United States Patent and Trademark Office