



US00D445958S

(12) **United States Design Patent**
Dansreau et al.

(10) **Patent No.:** **US D445,958 S**

(45) **Date of Patent:** **** Jul. 31, 2001**

(54) **RAZOR HANDLE**

(75) Inventors: **Paul Dansreau**, Shelton; **Thomas Follo**, Milford; **Andrew Pennella**, Stamford; **Javier Verdura**, Milford, all of CT (US)

(73) Assignee: **Warner-Lambert Company**, Morris Plains, NJ (US)

(**) Term: **14 Years**

(21) Appl. No.: **29/098,111**

(22) Filed: **Dec. 22, 1998**

(51) **LOC (7) Cl.** **28-03**

(52) **U.S. Cl.** **D28/48**

(58) **Field of Search** D28/45, 46, 48; 30/32, 47, 526, 527, 530-533; D8/303, 107, DIG. 7; D4/104

(56) **References Cited**

U.S. PATENT DOCUMENTS

Re. 34,194	*	3/1993	Stowell et al.	16/421
D. 193,299	*	7/1962	Dreyfuss	D28/46
D. 218,001	*	7/1970	Goyke et al.	D28/48
D. 248,878	*	8/1978	Halm	D28/46
D. 270,382	*	8/1983	Poisson	D28/46
D. 283,260	*	4/1986	Alvarez	D28/48
D. 355,049	*	1/1995	Yasui	D28/48
D. 377,238	*	1/1997	Byrne	D28/48
D. 389,955	*	1/1998	Wonderley	D28/48
D. 403,946	*	1/1999	Shih	D8/303

D. 404,280	*	1/1999	Wen	D8/107
D. 414,298	*	9/1999	Pennella et al.	D28/48
D. 415,317	*	10/1999	Aiston	D28/48
D. 416,108	*	11/1999	Shurtleff et al.	D28/46
D. 421,155	*	2/2000	Grange	D28/48

* cited by examiner

Primary Examiner—C Tuttle

(74) *Attorney, Agent, or Firm*—Charles W. Almer

(57) **CLAIM**

The ornamental design for a razor handle, as shown and described.

DESCRIPTION

FIG. 1 is a top perspective view of the razor handle; FIG. 2 is a bottom perspective view of the razor handle; FIG. 3 is a front end view of the razor handle; FIG. 4 is a rear end view of the razor handle; FIG. 5 is a top view of the razor handle; FIG. 6 is a side view of the razor handle the side opposite being a mirror image of the side shown; and, FIG. 7 is a bottom view of the razor handle.

The broken lines showing portions of the razor are for illustrative purposes only and form no part of the claimed design; and the broken circular outlines defining the bounds of the claim on the bottom surface form no part thereof.

The surface(s) or portion(s) of the article not shown in the drawing or described in the specification form(s) no part of the claimed design.

1 Claim, 6 Drawing Sheets

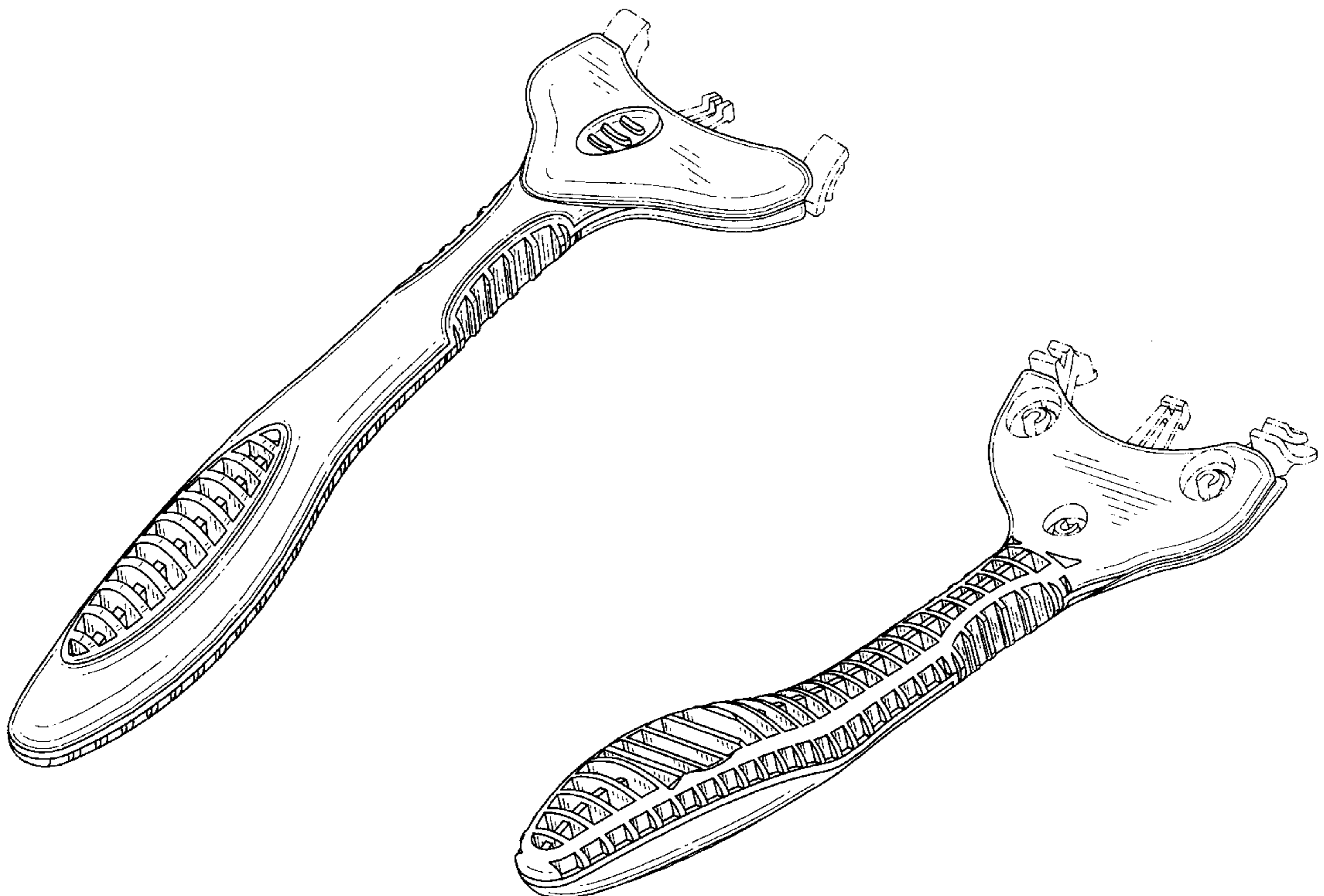

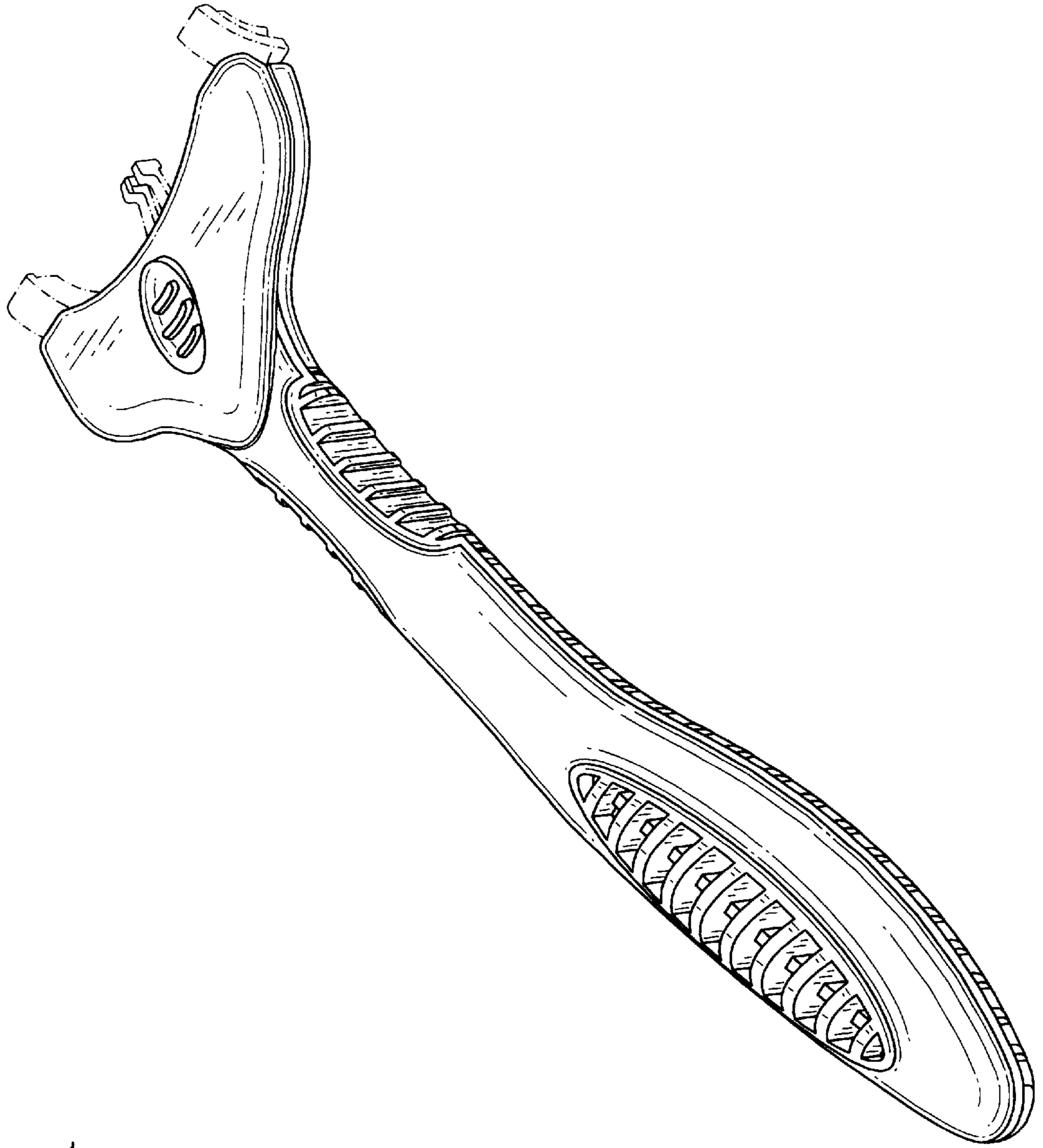

FIG-1

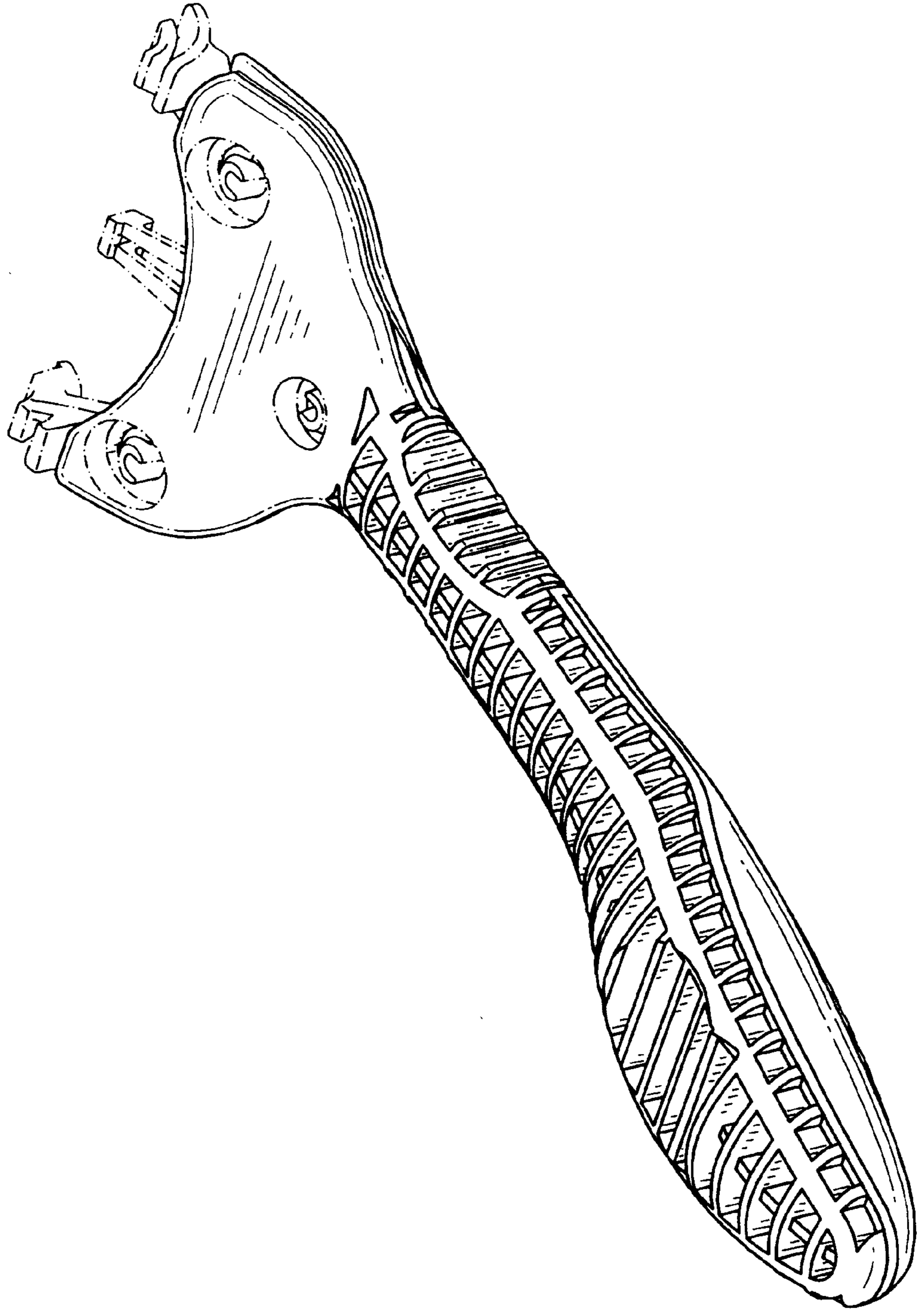

FIG-2

FIG-4

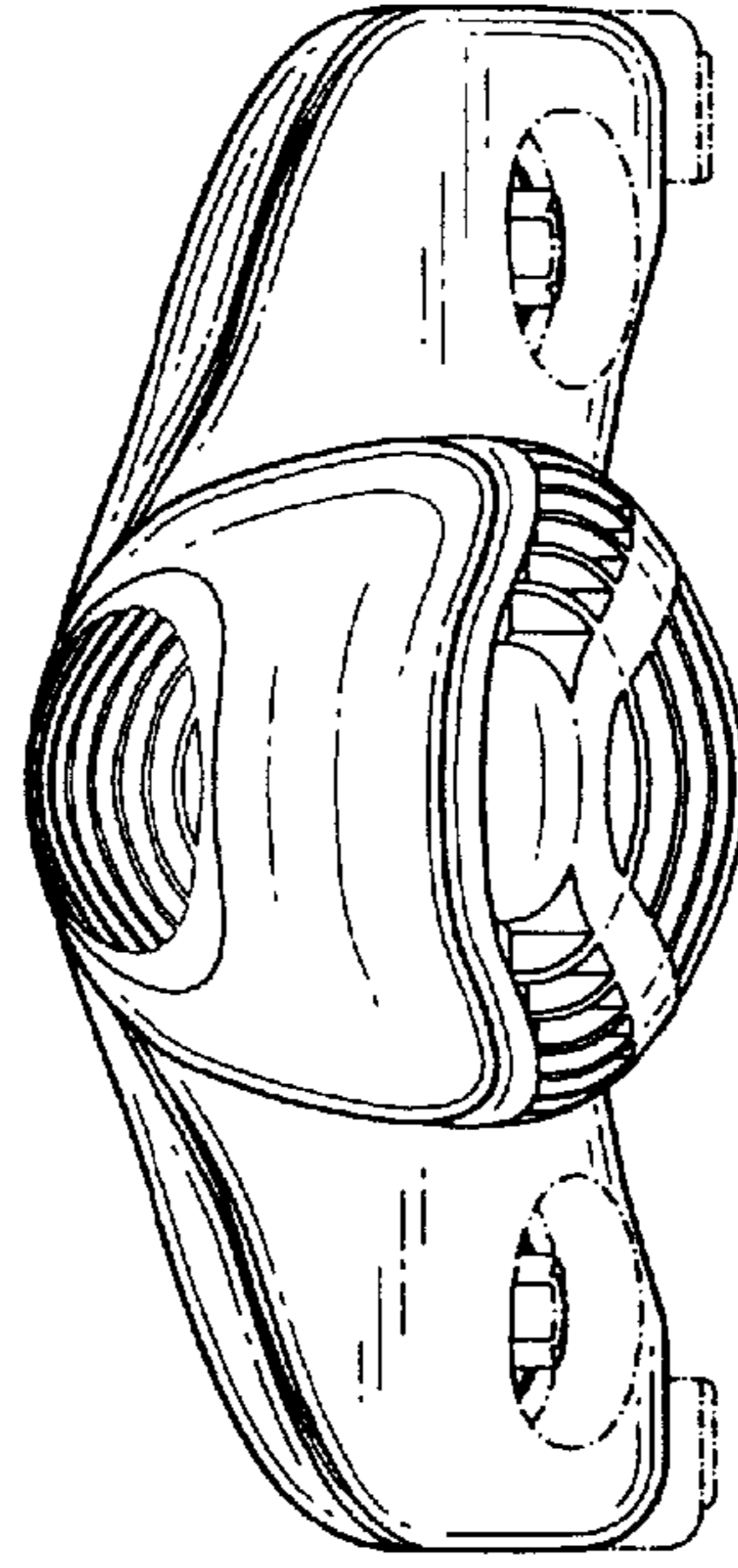
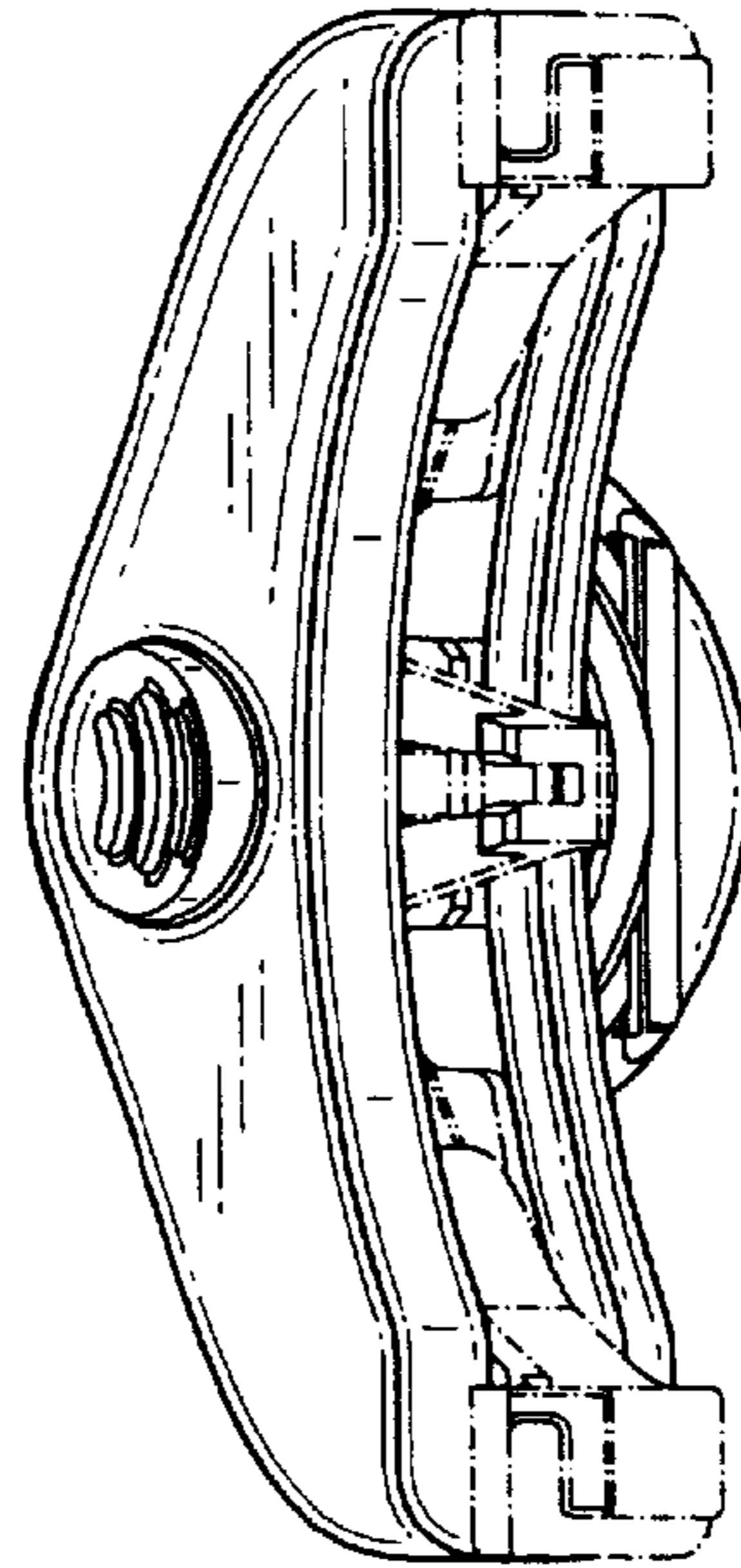

FIG-3



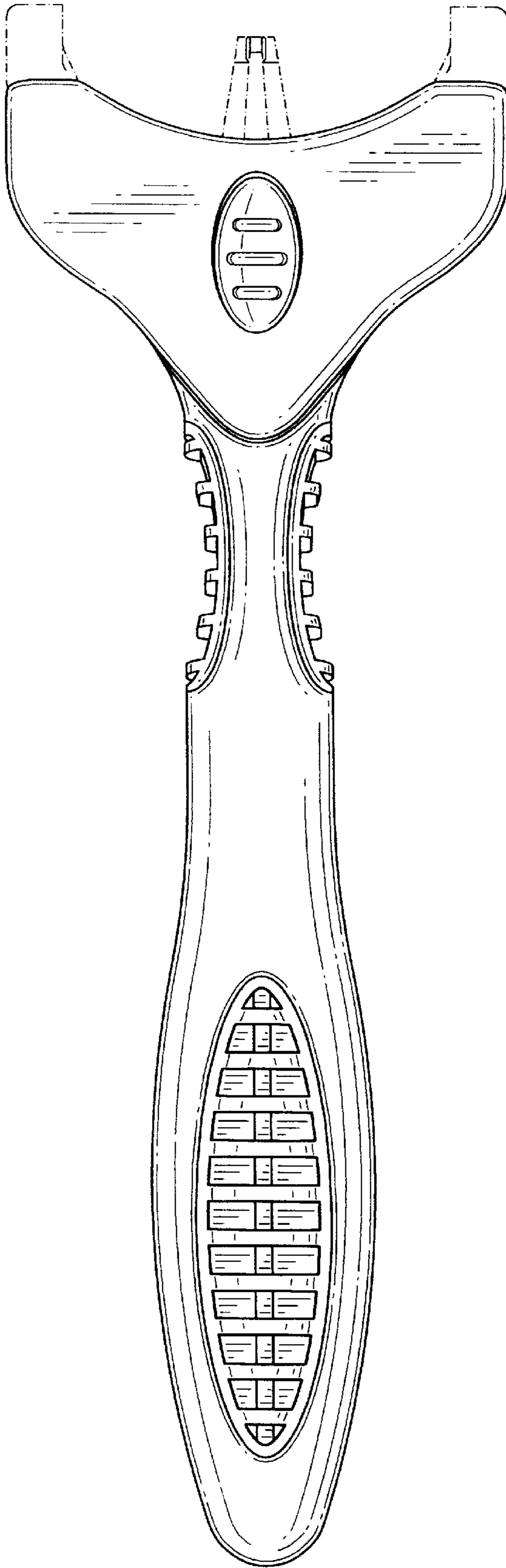
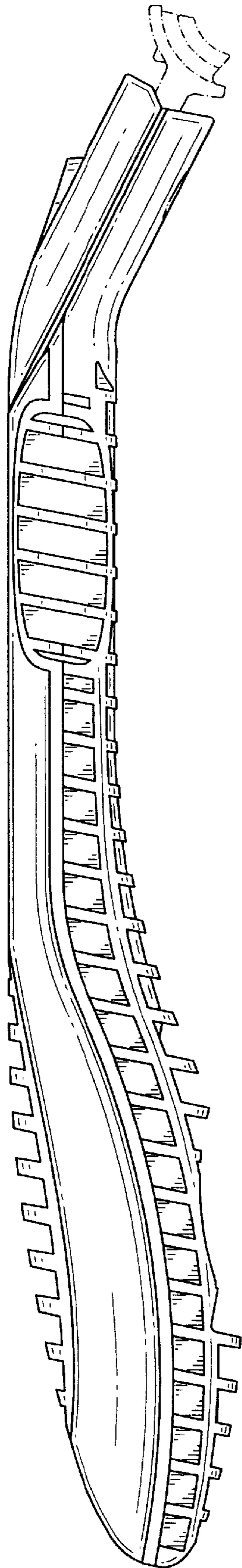

FIG-5

FIG-6



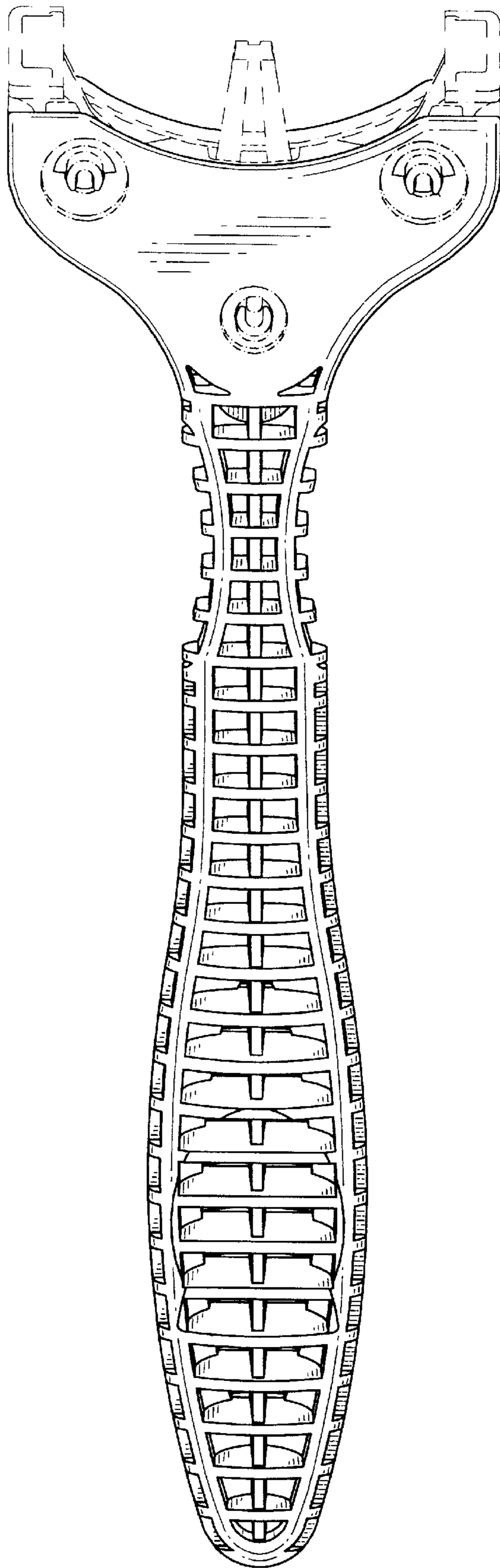

FIG-7