



US00D445942S

(12) **United States Design Patent**
Hsu

(10) **Patent No.:** **US D445,942 S**

(45) **Date of Patent:** **** Jul. 31, 2001**

(54) **PENDENT LAMP**

(75) Inventor: **Peter Hsu**, Taichung (TW)

(73) Assignee: **Dong Guan Bright Yin Huey Lighting Co., Ltd.**, Guang Dong (CN)

(**) Term: **14 Years**

(21) Appl. No.: **29/126,092**

(22) Filed: **Jul. 11, 2000**

(51) **LOC (7) Cl.** **26-05**

(52) **U.S. Cl.** **D26/85**

(58) **Field of Search** D26/72, 80-92;
362/147, 404-408, 432

(56) **References Cited**

U.S. PATENT DOCUMENTS

D. 206,178 * 11/1966 Eckert D26/72

OTHER PUBLICATIONS

Home Decorator's Collection, summer, 1997, p. 51, F flush mount.*

Quoizel lighting catalog, 1997, p. 27, p. 27, chandelier # ML 102Z.*

Murray Feiss Lighting catalog, Mar. 1995, p. FX ceiling lamp #F1539/3 VG.*

* cited by examiner

Primary Examiner—Susan J. Lucas

(74) *Attorney, Agent, or Firm*—Rosenberg, Klein & Lee

(57) **CLAIM**

The ornamental design for a pendent lamp, as shown and described.

DESCRIPTION

FIG. 1 is a perspective view of pendent lamp showing my new design;

FIG. 2 is a front elevation view, the rear elevation view thereof being identical in appearance;

FIG. 3 is a left side elevation view, the right side elevation view thereof being identical in appearance;

FIG. 4 is a top plan view thereof; and,

FIG. 5 is a bottom plan view thereof.

1 Claim, 4 Drawing Sheets

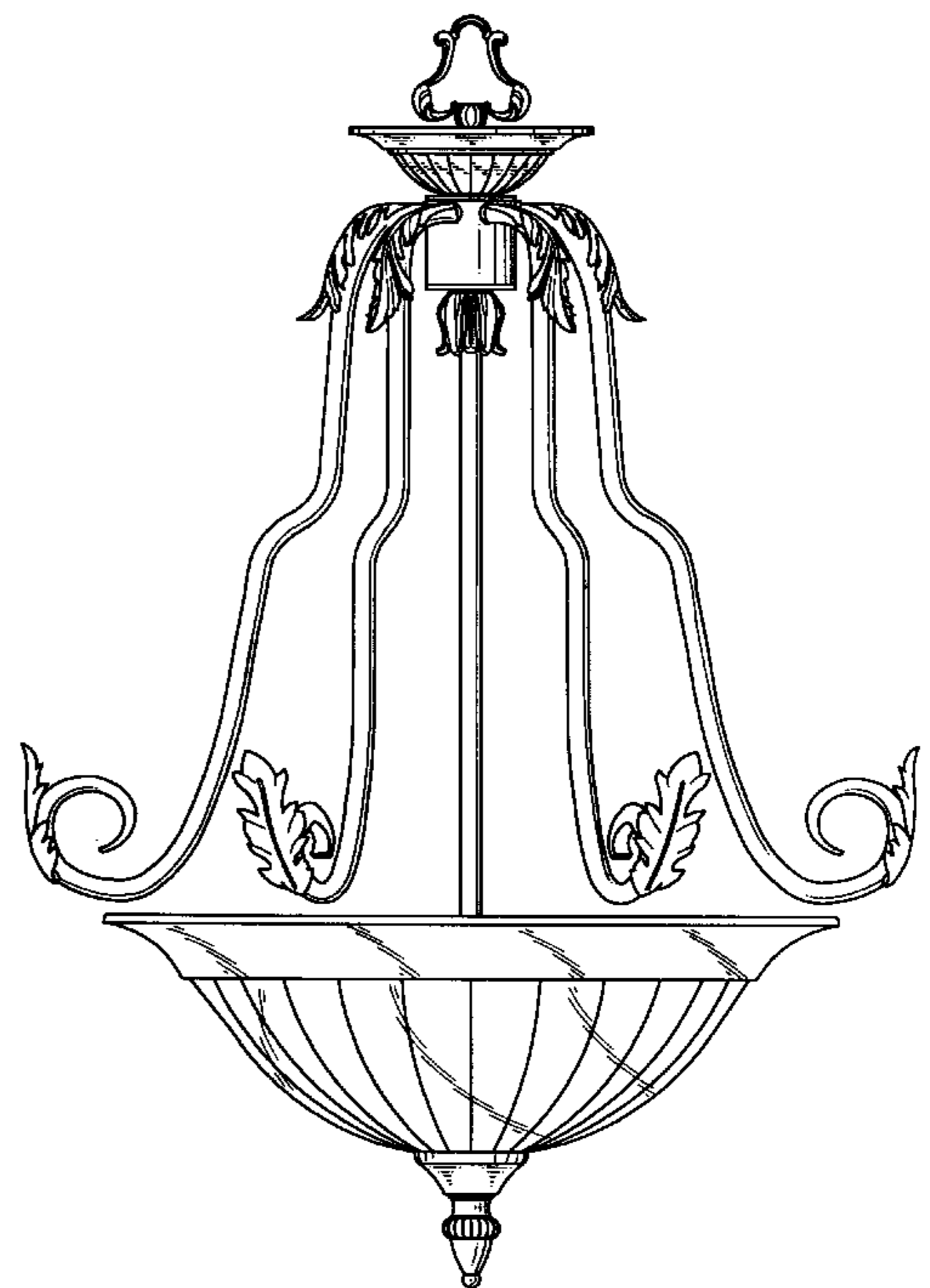
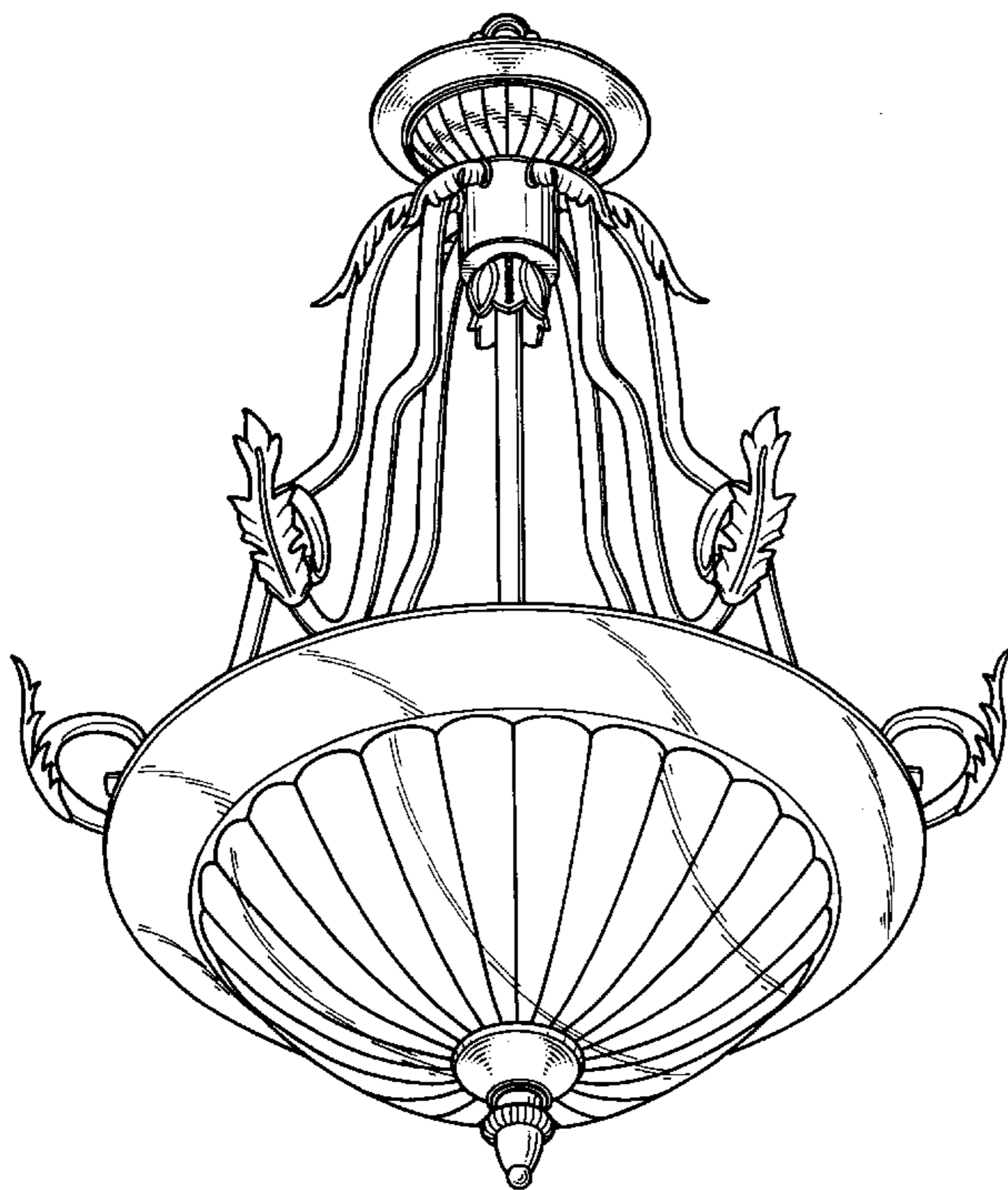

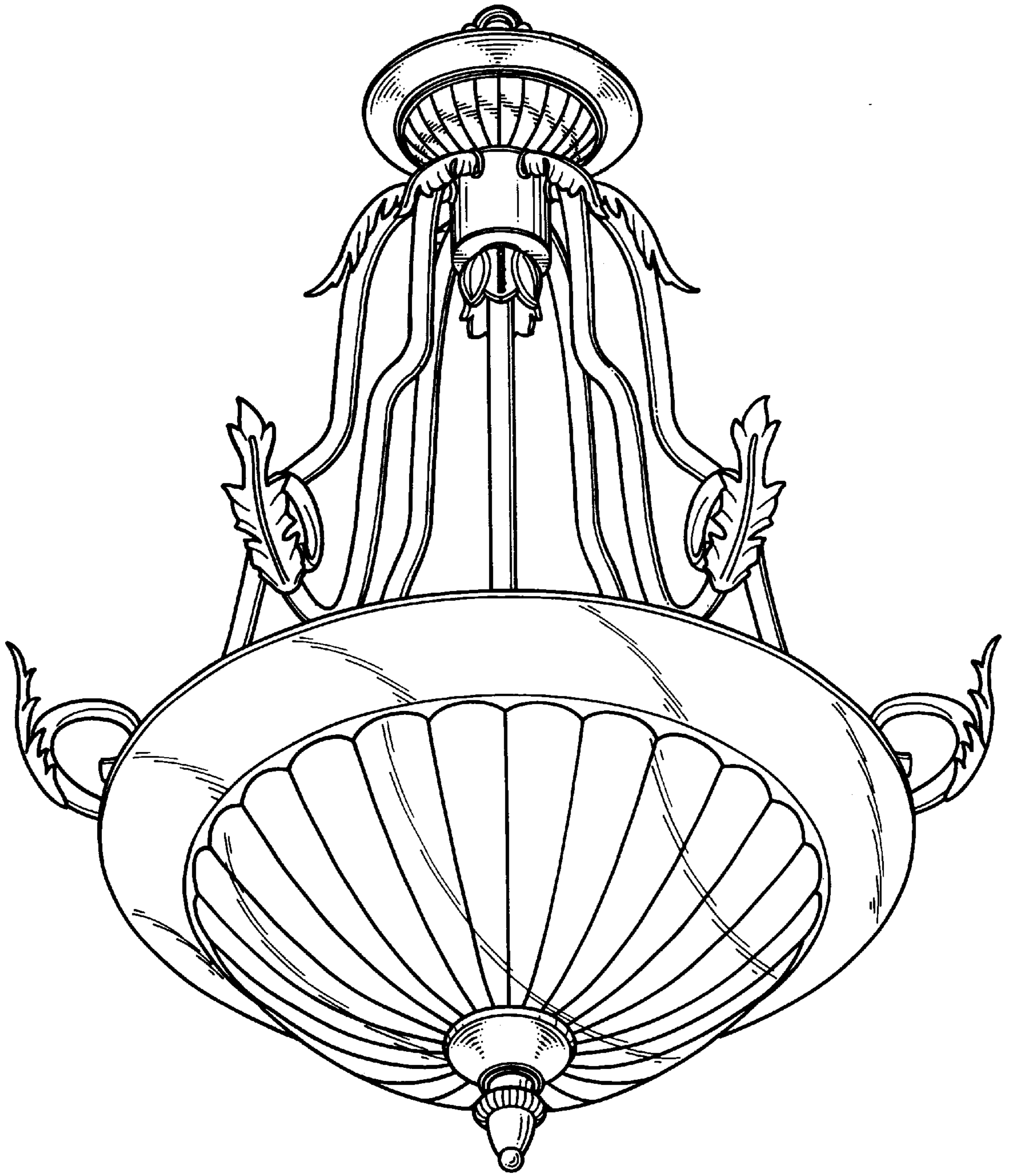

FIG. 1

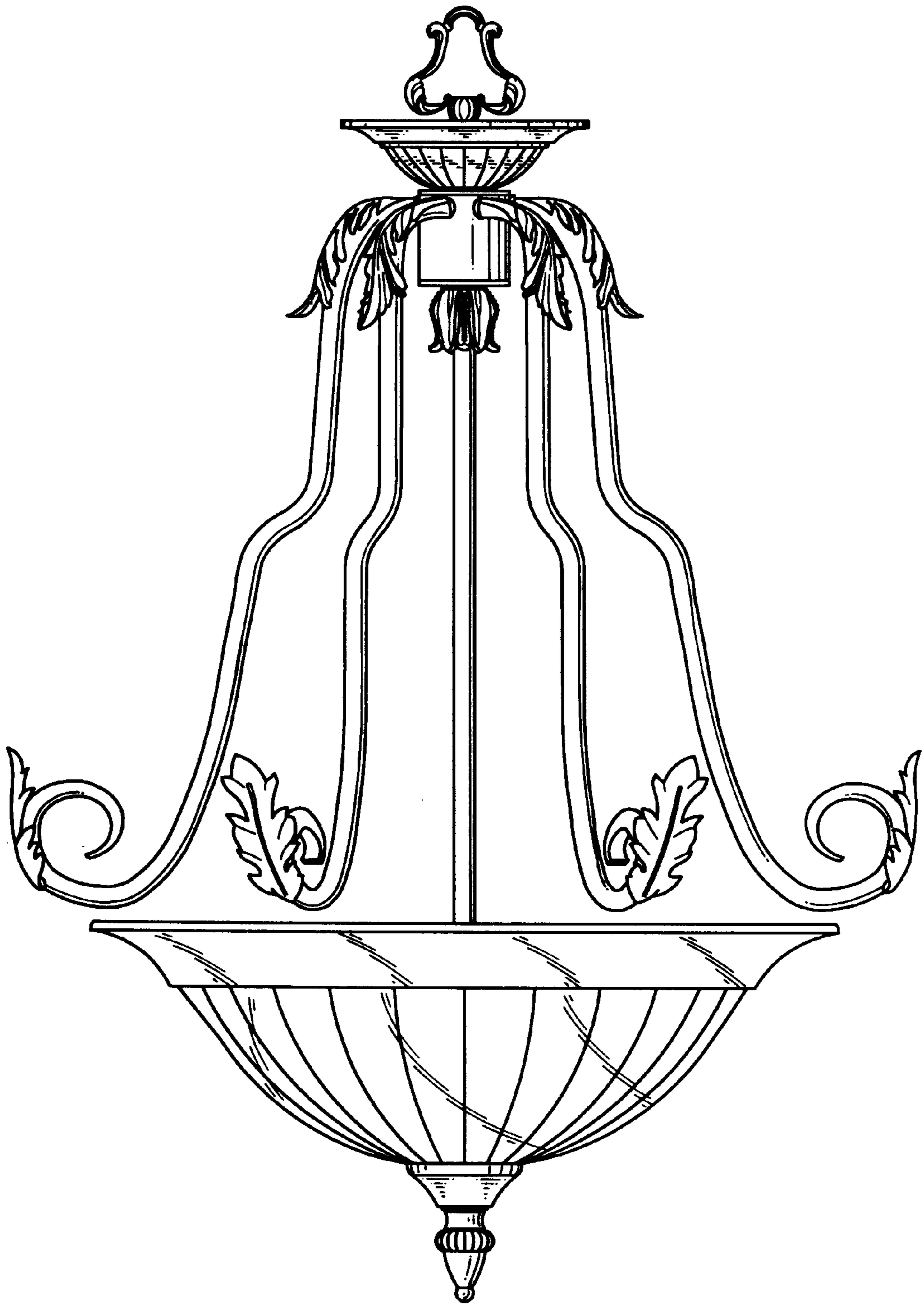

FIG. 2

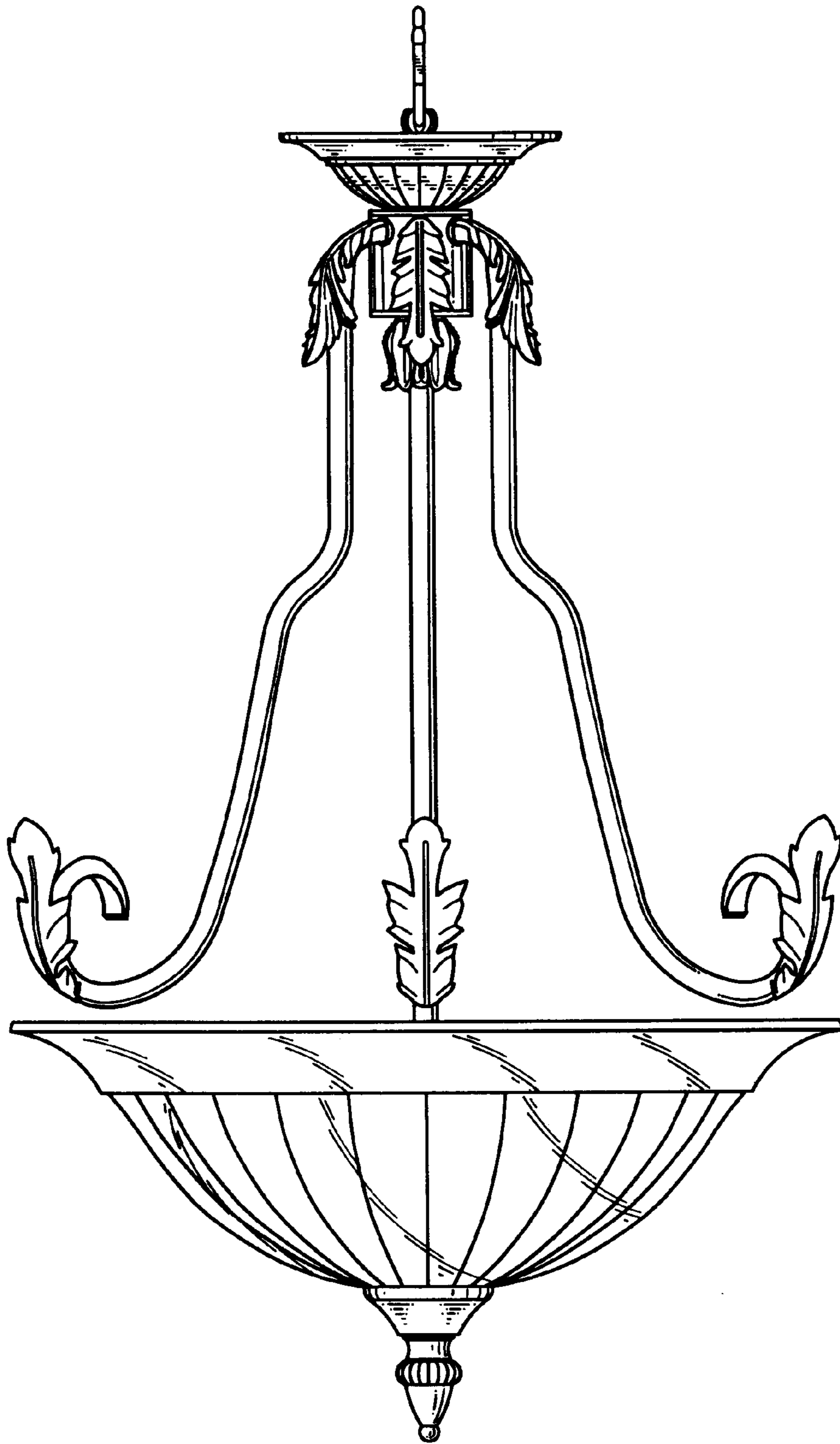

FIG. 3

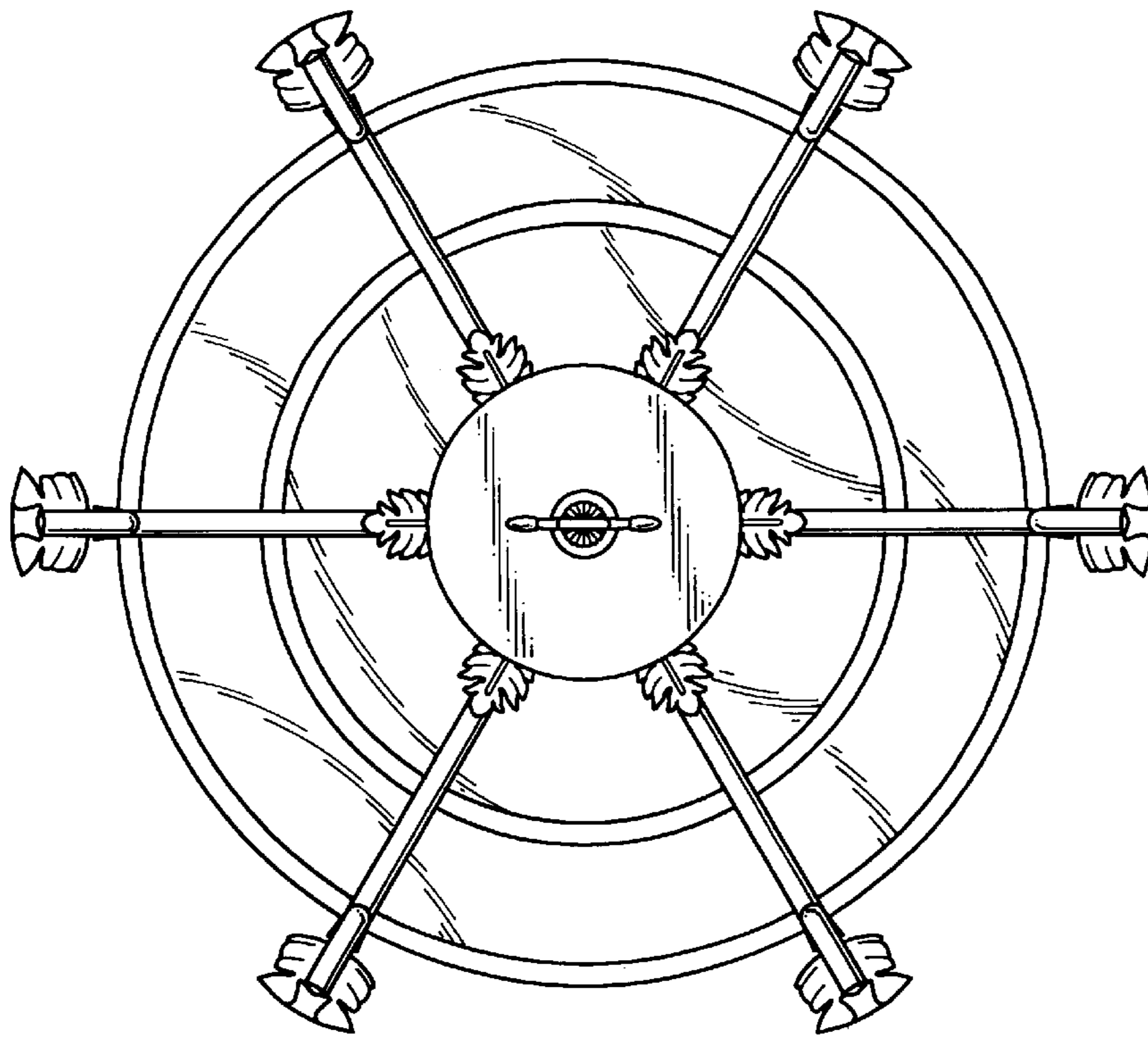

FIG. 4

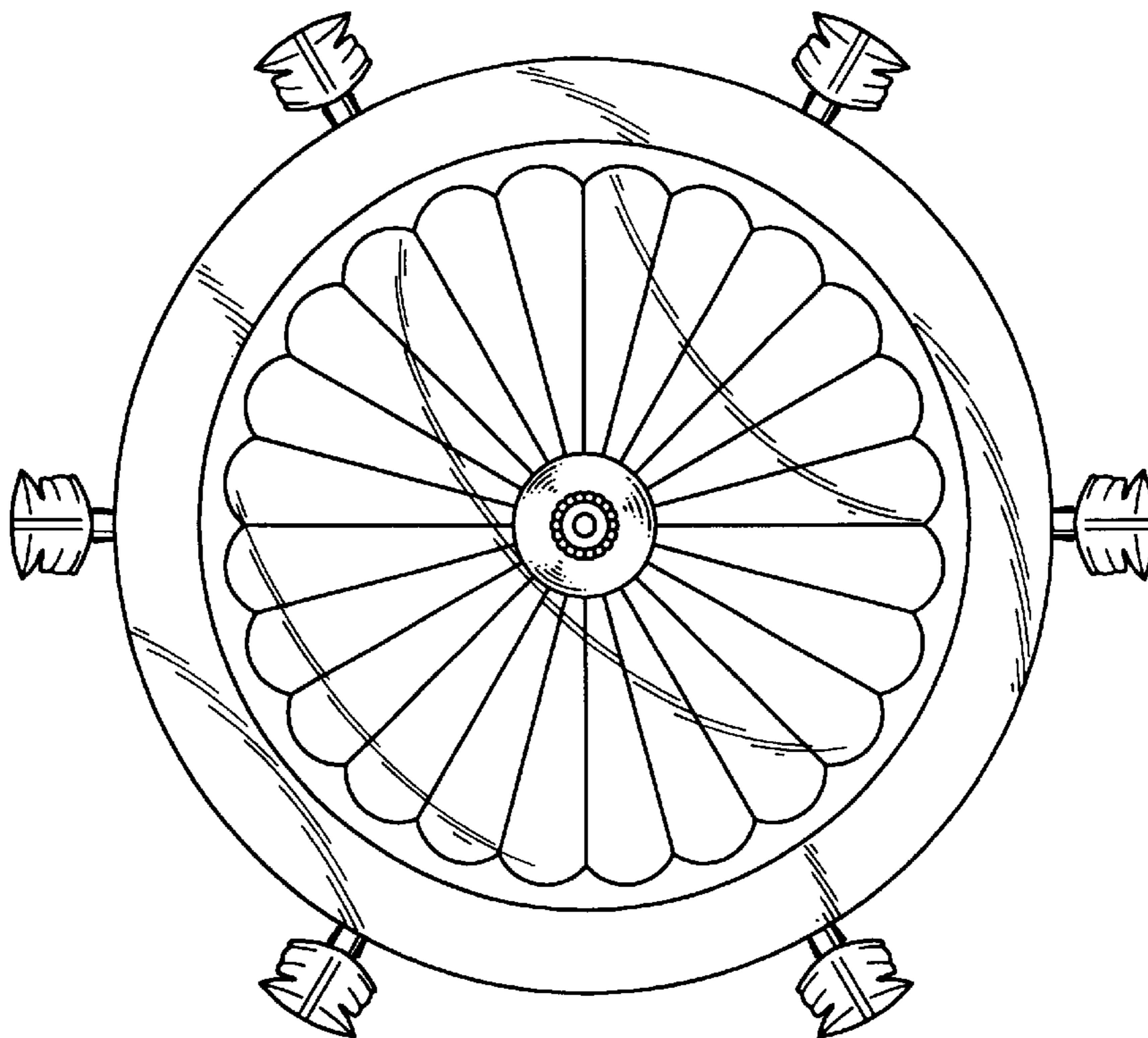

FIG. 5