



US00D445871S

(12) **United States Design Patent**
Fan

(10) **Patent No.:** **US D445,871 S**

(45) **Date of Patent:** **** Jul. 31, 2001**

(54) **SHOWER HEAD**

D. 433,097 * 10/2000 Tse D23/223

(76) Inventor: **Chen-Yueh Fan**, Room F/23, 4th Fl.,
No. 5, Sec. 5, Hsinyi Rd., Taipei (TW)

* cited by examiner

(**) Term: **14 Years**

Primary Examiner—Robin V. Taylor
(74) *Attorney, Agent, or Firm*—Fei-Fei Chao; Venable,
Baetjer, Howard & Civiletti, LLP

(21) Appl. No.: **29/132,181**

(57) **CLAIM**

(22) Filed: **Nov. 6, 2000**

The ornamental design for a shower head, as shown.

(51) **LOC (7) Cl.** **23-01**

DESCRIPTION

(52) **U.S. Cl.** **D23/223**

(58) **Field of Search** D23/213, 223,
D23/226, 229; 239/394, 462, 459

FIG. 1 is a front-right-top perspective view of a shower head, showing my new design;

FIG. 2 is a front elevational view thereof;

FIG. 3 is a rear elevational view thereof;

FIG. 4 is a left elevational view thereof;

FIG. 5 is a right elevational view thereof;

FIG. 6 is top plan view thereof; and,

FIG. 7 is a bottom plan view thereof.

(56) **References Cited**

U.S. PATENT DOCUMENTS

- D. 430,643 * 9/2000 Tse D23/223
- D. 431,278 * 9/2000 Tse D23/223
- D. 432,624 * 10/2000 Chan D23/223
- D. 432,625 * 10/2000 Chan D23/223
- D. 432,627 * 10/2000 Tse D23/223

1 Claim, 4 Drawing Sheets

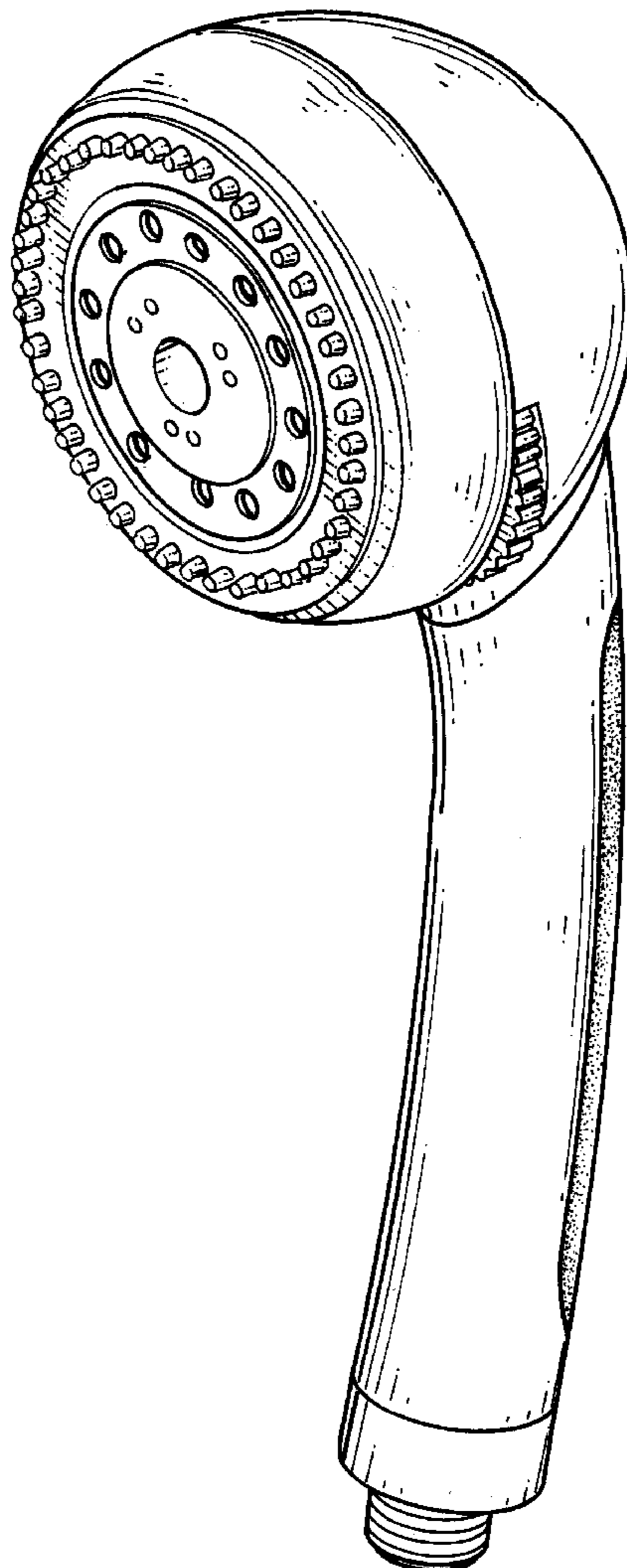

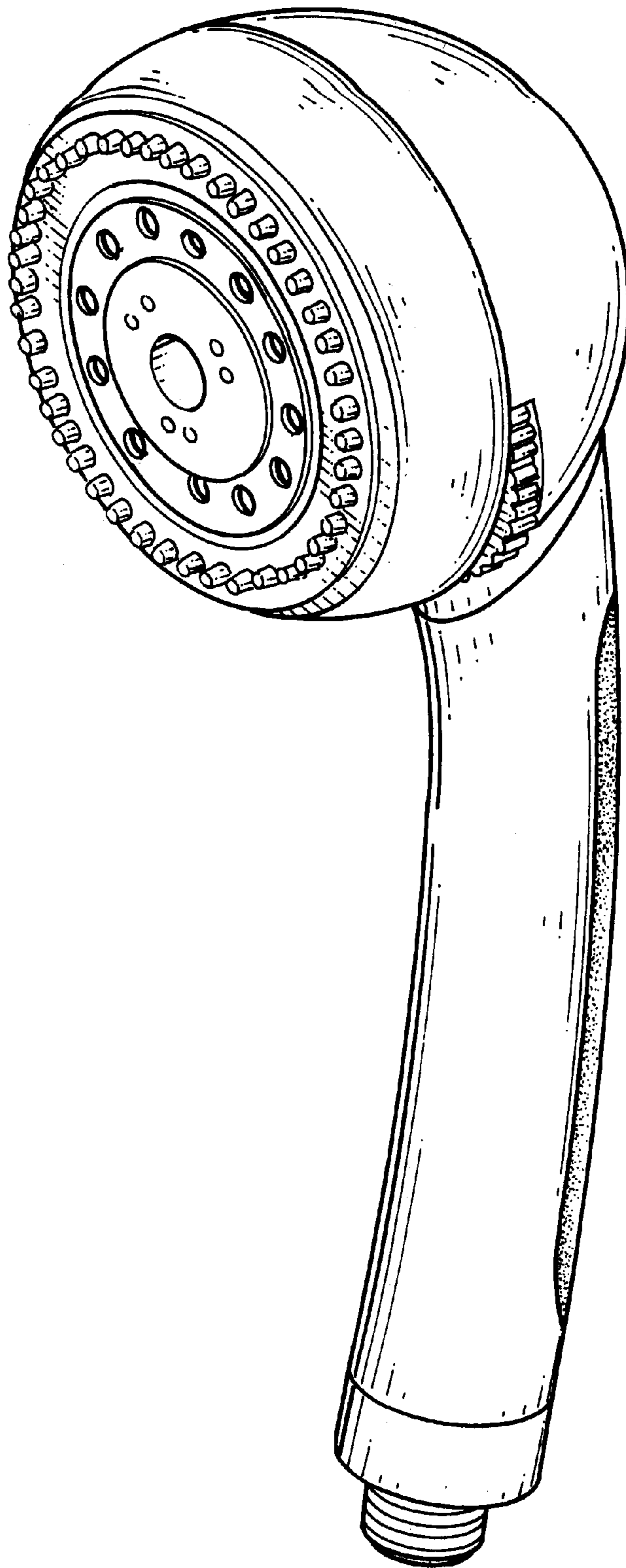

FIG. 1

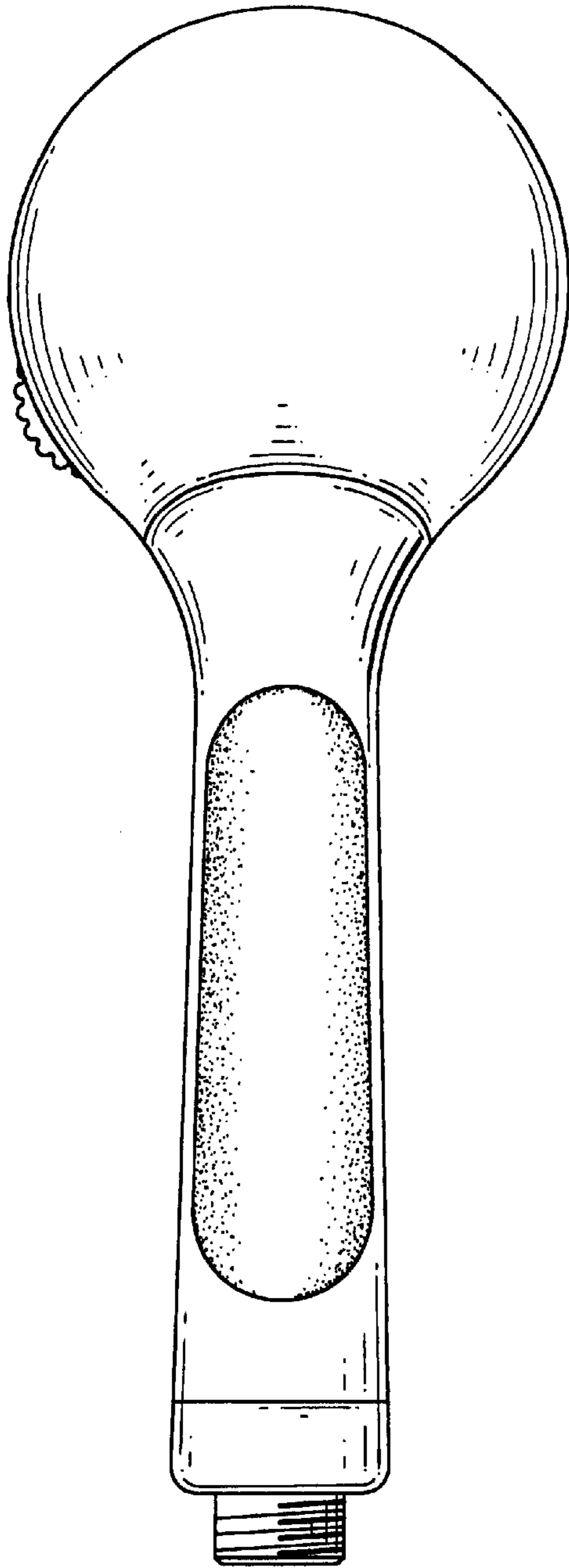

FIG. 3

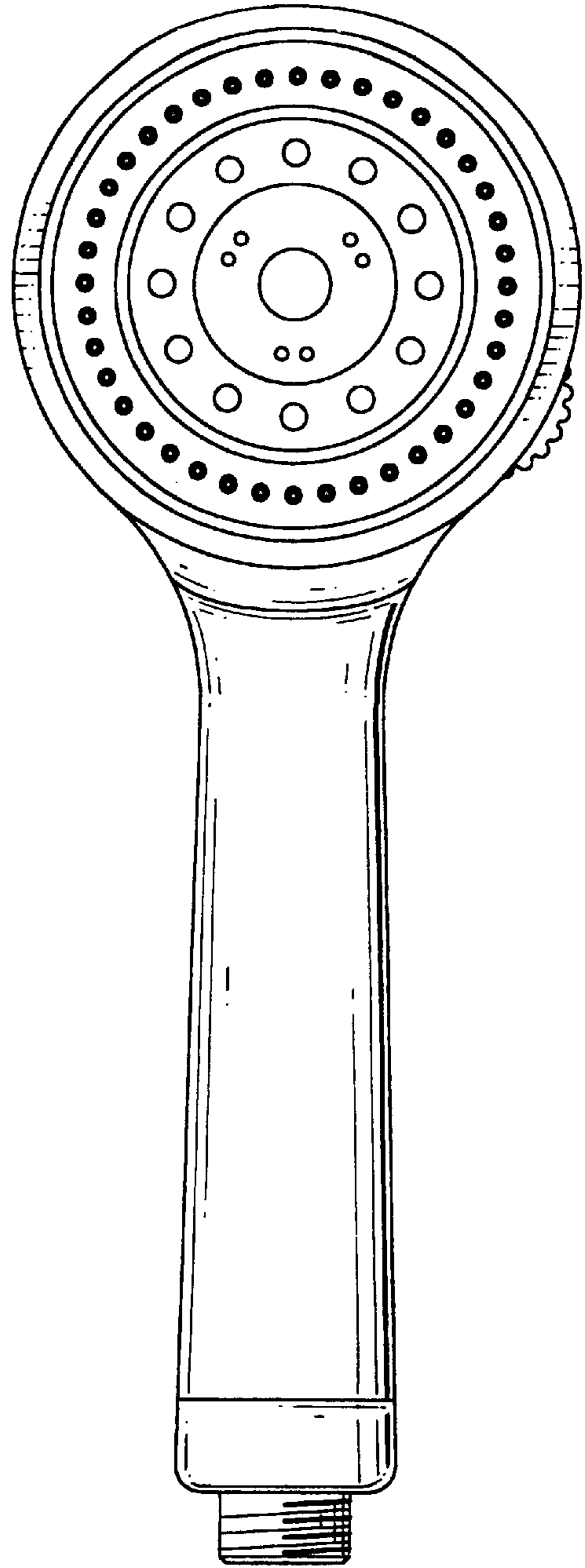

FIG. 2

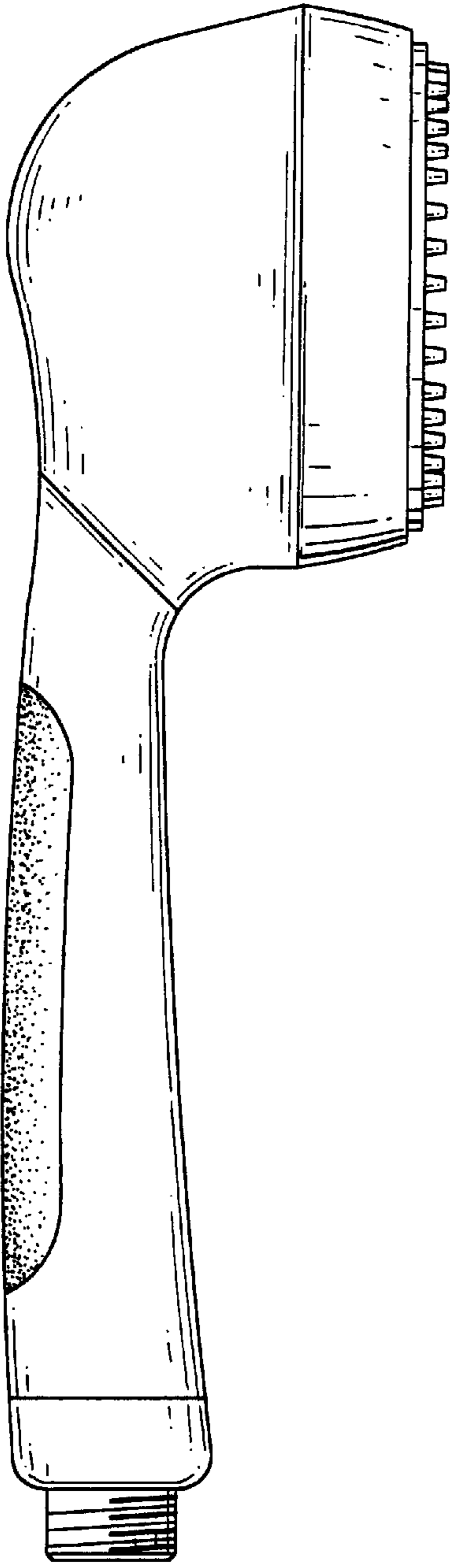

FIG. 4

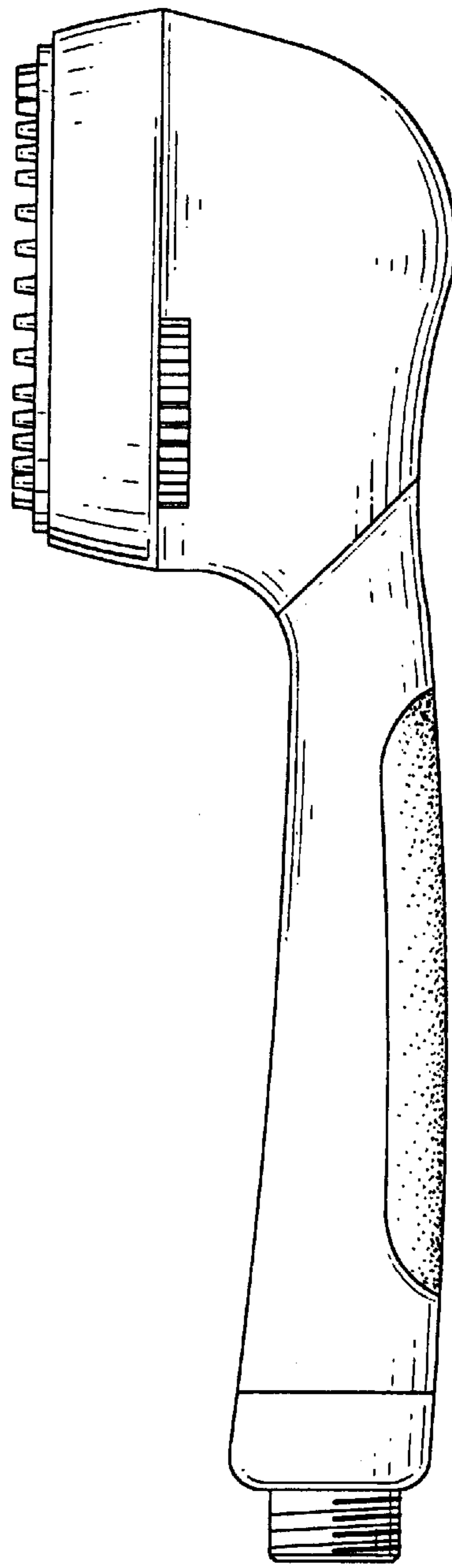

FIG. 5

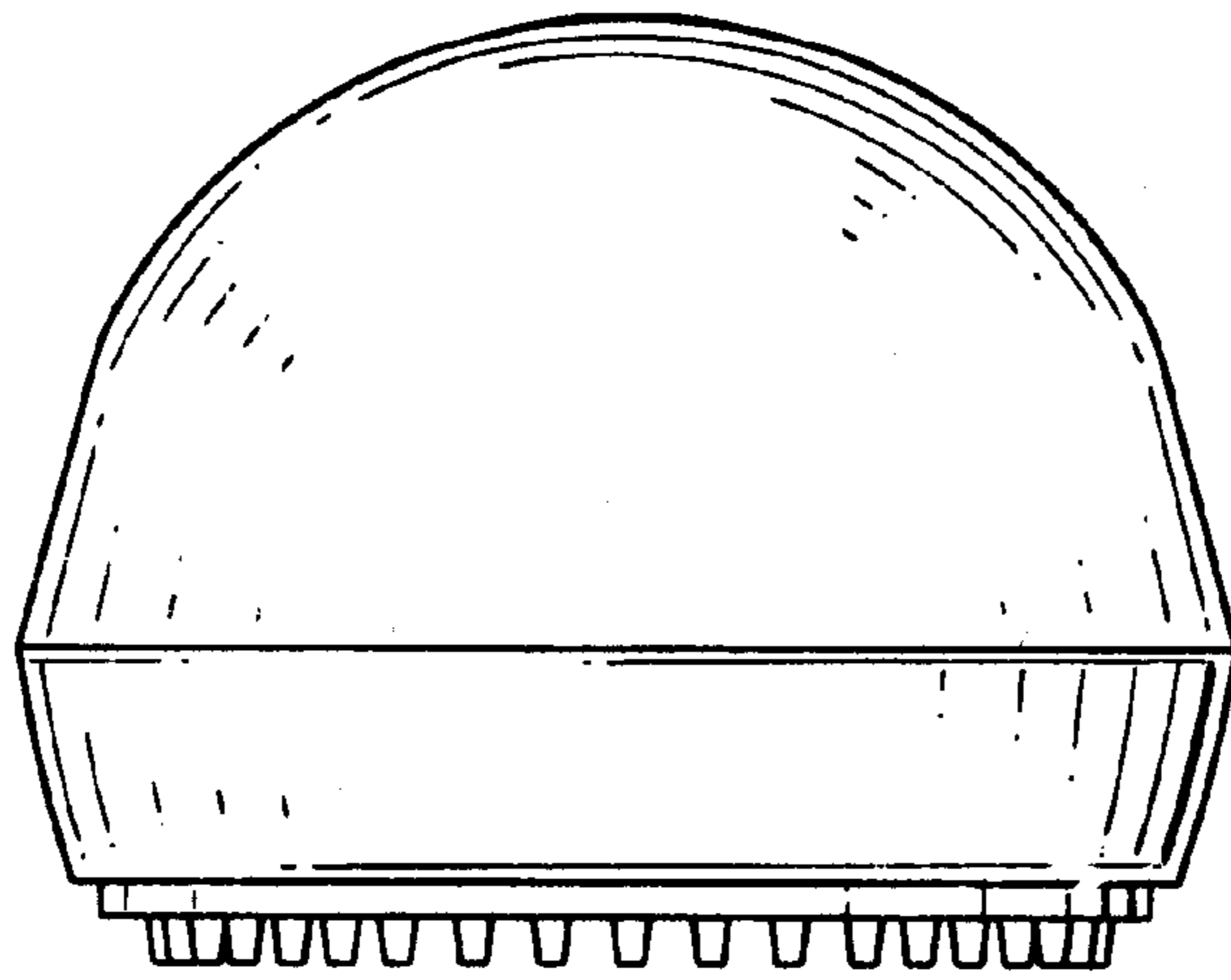

FIG. 6

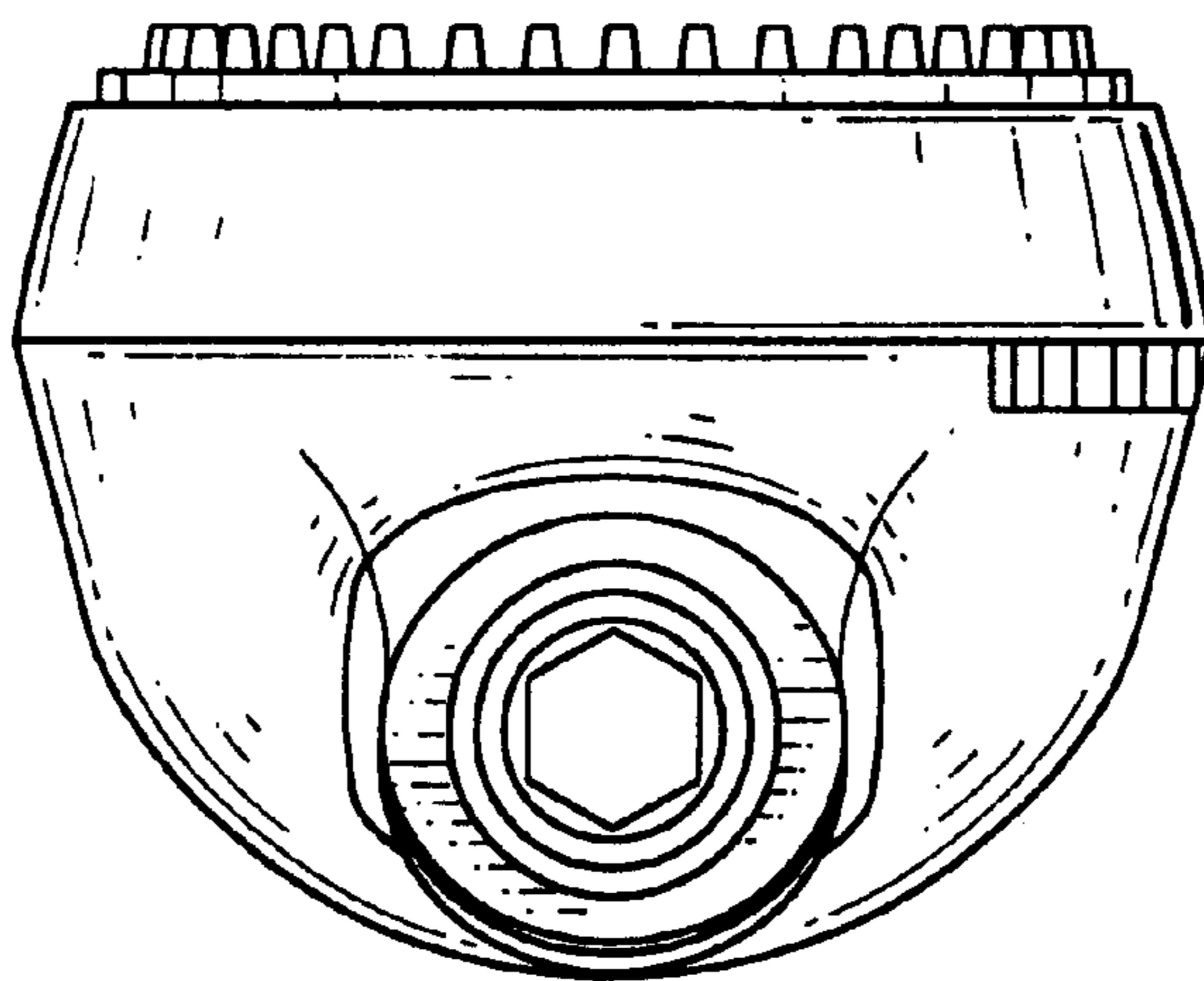

FIG. 7