



US00D445649S

(12) **United States Design Patent**
Maxwell et al.

(10) **Patent No.: US D445,649 S**

(45) **Date of Patent: ** Jul. 31, 2001**

(54) **CONTAINER FOR FOOD**

(75) Inventors: **Jason Maxwell**, Elgin, IL (US); **Jim Warner**, Hoboken; **Robert Croft**, Jersey City, both of NJ (US); **Insun Yun**, New York, NY (US)

(73) Assignee: **The Glad Products Company**, Oakland, CA (US)

(*) Notice: This patent is subject to a terminal disclaimer.

(**) Term: **14 Years**

(21) Appl. No.: **29/126,690**

(22) Filed: **Jul. 20, 2000**

(51) **LOC (7) Cl.** **07-07**

(52) **U.S. Cl.** **D7/629**

(58) **Field of Search** D7/602, 629, 538-542; D9/415, 418, 423-425, 432; 220/662, 675, 780-783, 792-799, 805

3,448,888	6/1969	Smith et al. .	
3,452,896	7/1969	Elliot .	
4,373,642	2/1983	Wolters et al. .	
4,787,527	* 11/1988	Monetti	220/801 X
4,819,824	4/1989	Longbottom et al. .	
5,377,860	1/1995	Littlejohn et al. .	
5,624,051	4/1997	Ahern, Jr. et al. .	

OTHER PUBLICATIONS

Branson Ultrasonics Corporation, print advertisement, *Packaging*, p. 80, 1989.

"Marketplace," *Restaurants & Institutions*, Apr. 17, 1989, p. 194.

American Permanent Ware, Steam Table Pans print advertisement, 1972, p. 5.

* cited by examiner

Primary Examiner—Terry A. Wallace

(74) *Attorney, Agent, or Firm*—Thomas C. Feix

(57) **CLAIM**

The ornamental design for a container for food, as shown and described.

(56) **References Cited**

U.S. PATENT DOCUMENTS

D. 272,595	2/1984	Chase et al. .
D. 285,906	9/1986	Tyler .
D. 313,556	1/1991	Smith .
D. 334,114	3/1993	Narsutis .
D. 336,850	6/1993	Guillin .
D. 379,431	5/1997	Mangla .
D. 388,325	12/1997	Tucker et al. .
D. 390,109	2/1998	Tucker et al. .
3,424,342	1/1969	Scopp et al. .
3,447,714	6/1969	Elliot .

DESCRIPTION

FIG. 1 is a top perspective view of a container for food showing our new design;

FIG. 2 is a top plan view thereof;

FIG. 3 is a right side elevational view thereof;

FIG. 4 is a front elevational view thereof;

FIG. 5 is a left side elevational view thereof;

FIG. 6. is a rear elevational view thereof; and,

FIG. 7; is a bottom plan view thereof.

1 Claim, 3 Drawing Sheets

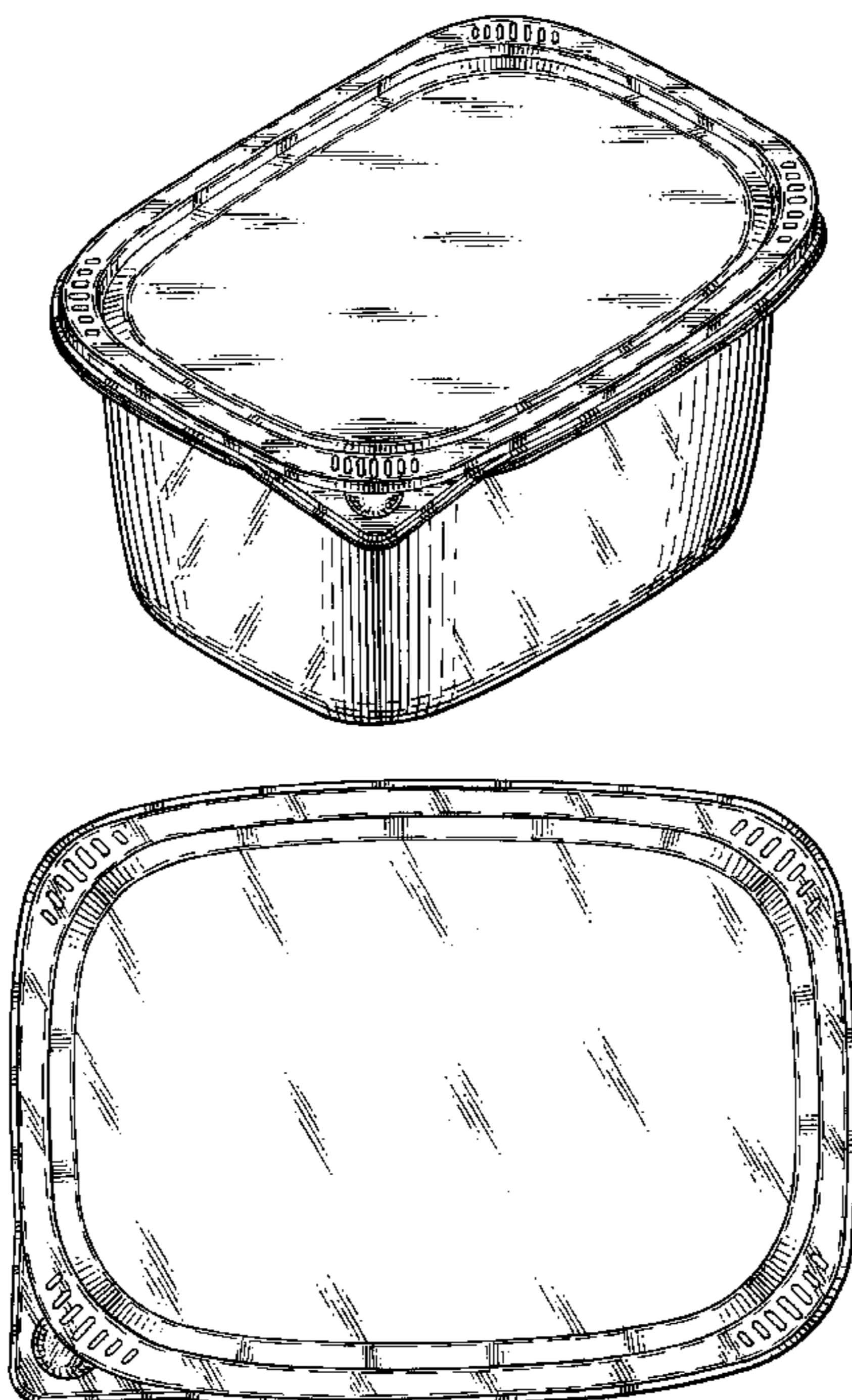

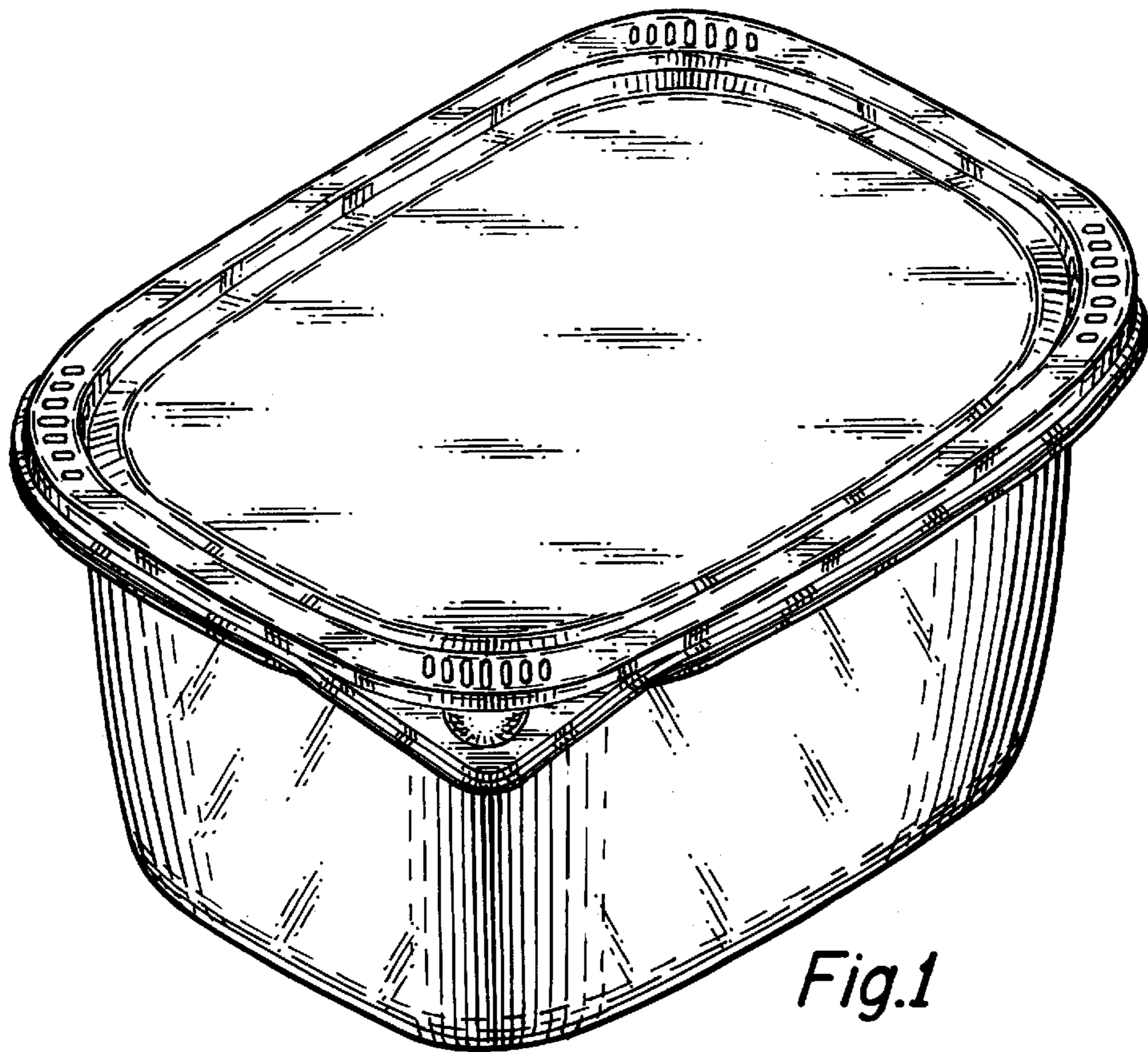

Fig.1

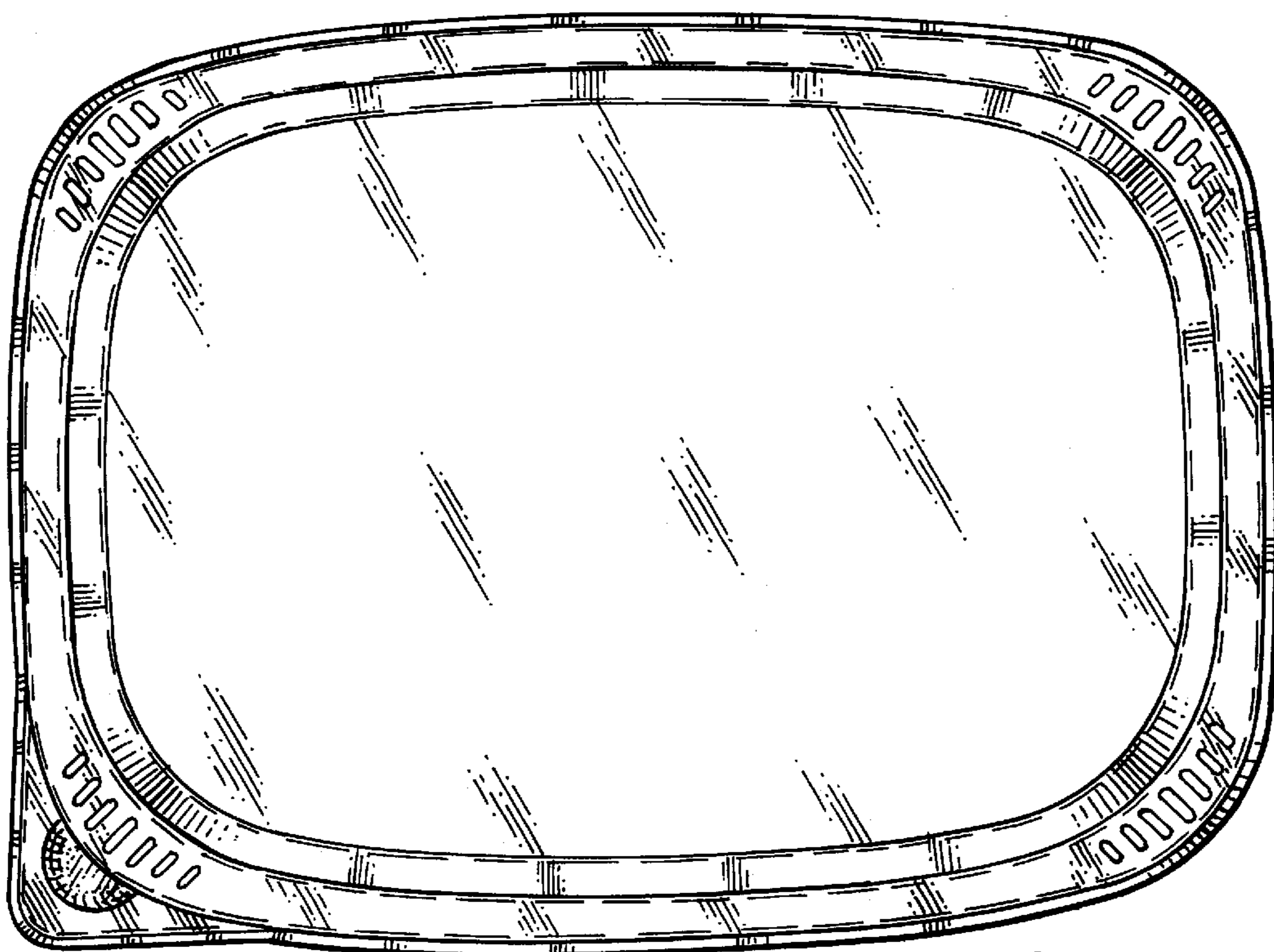

Fig.2

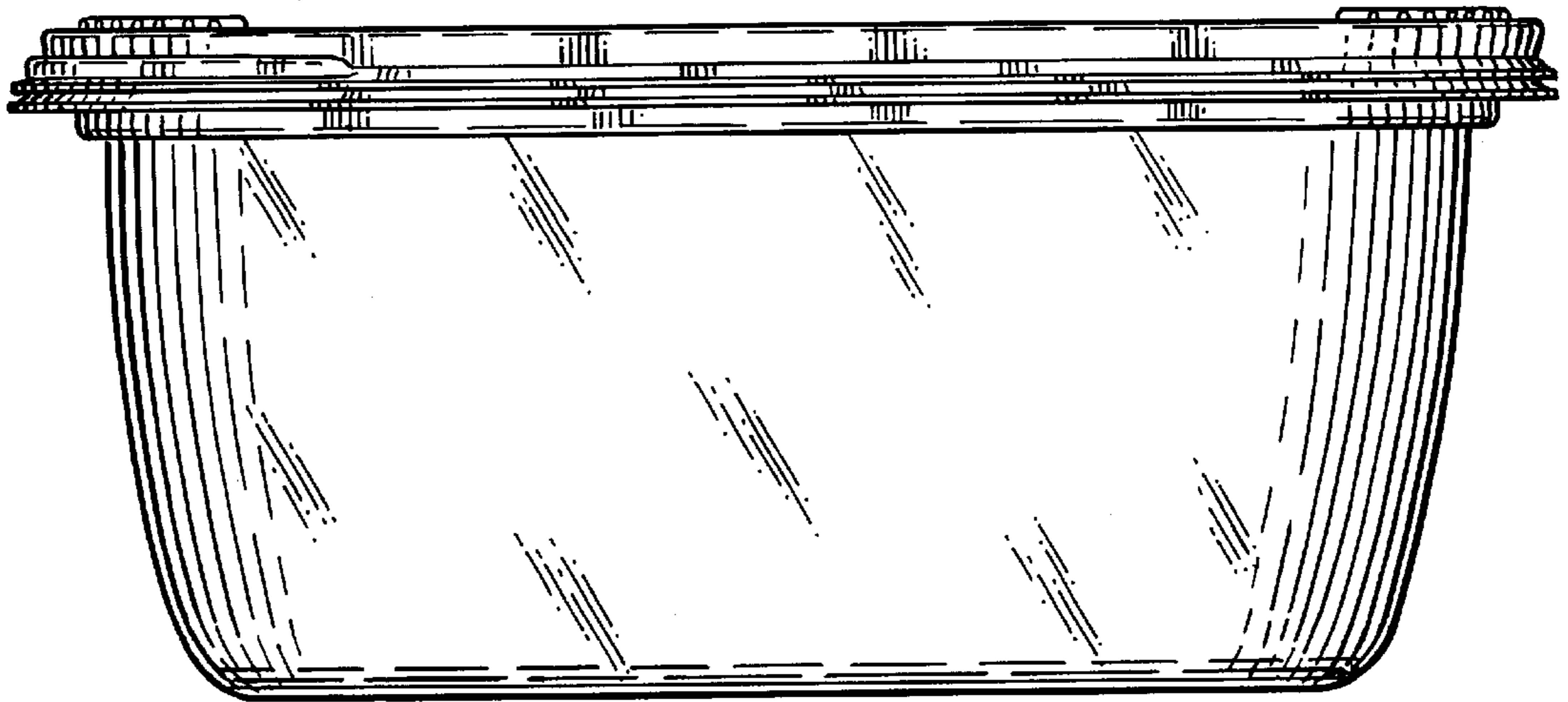

Fig.3

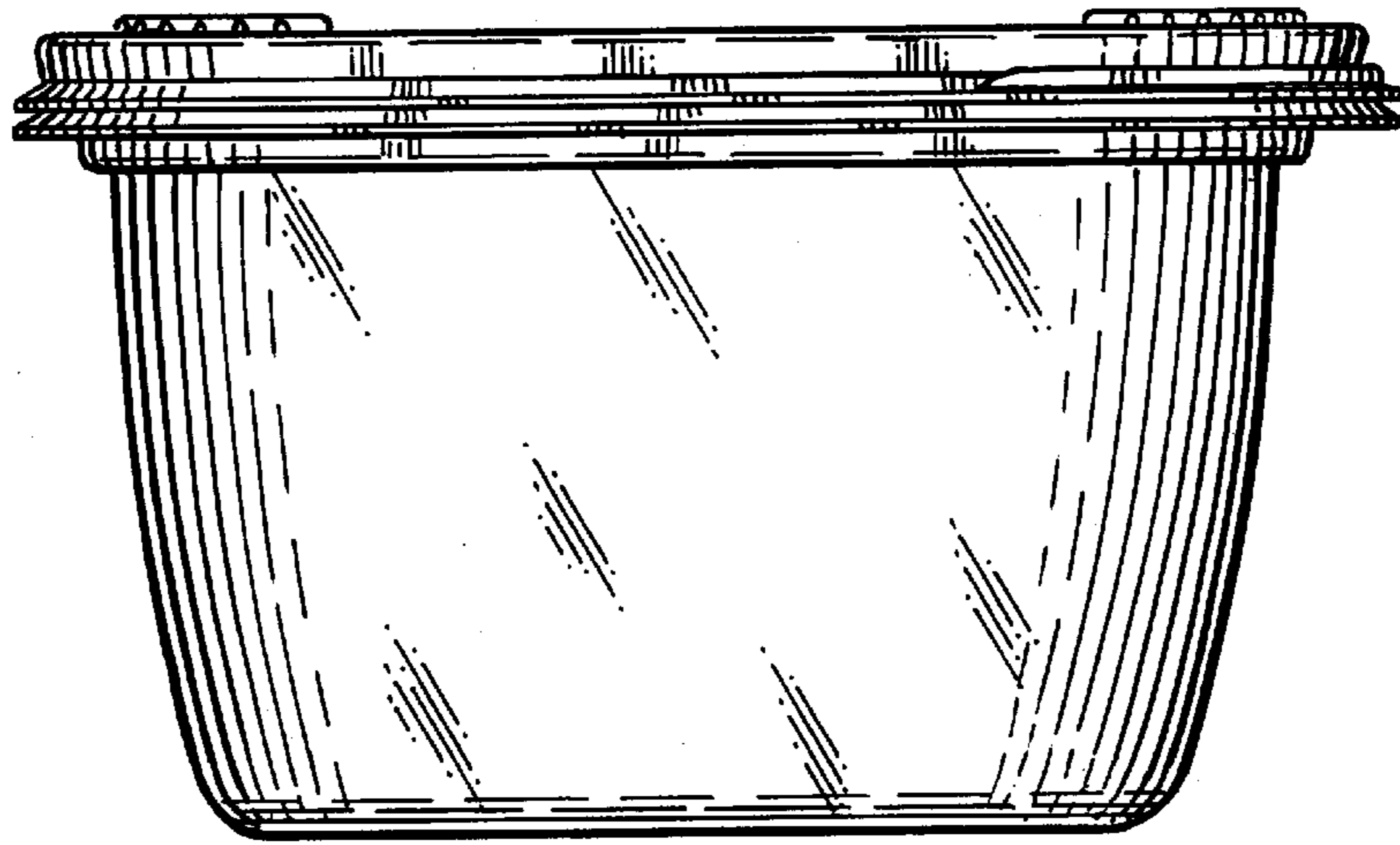

Fig.4

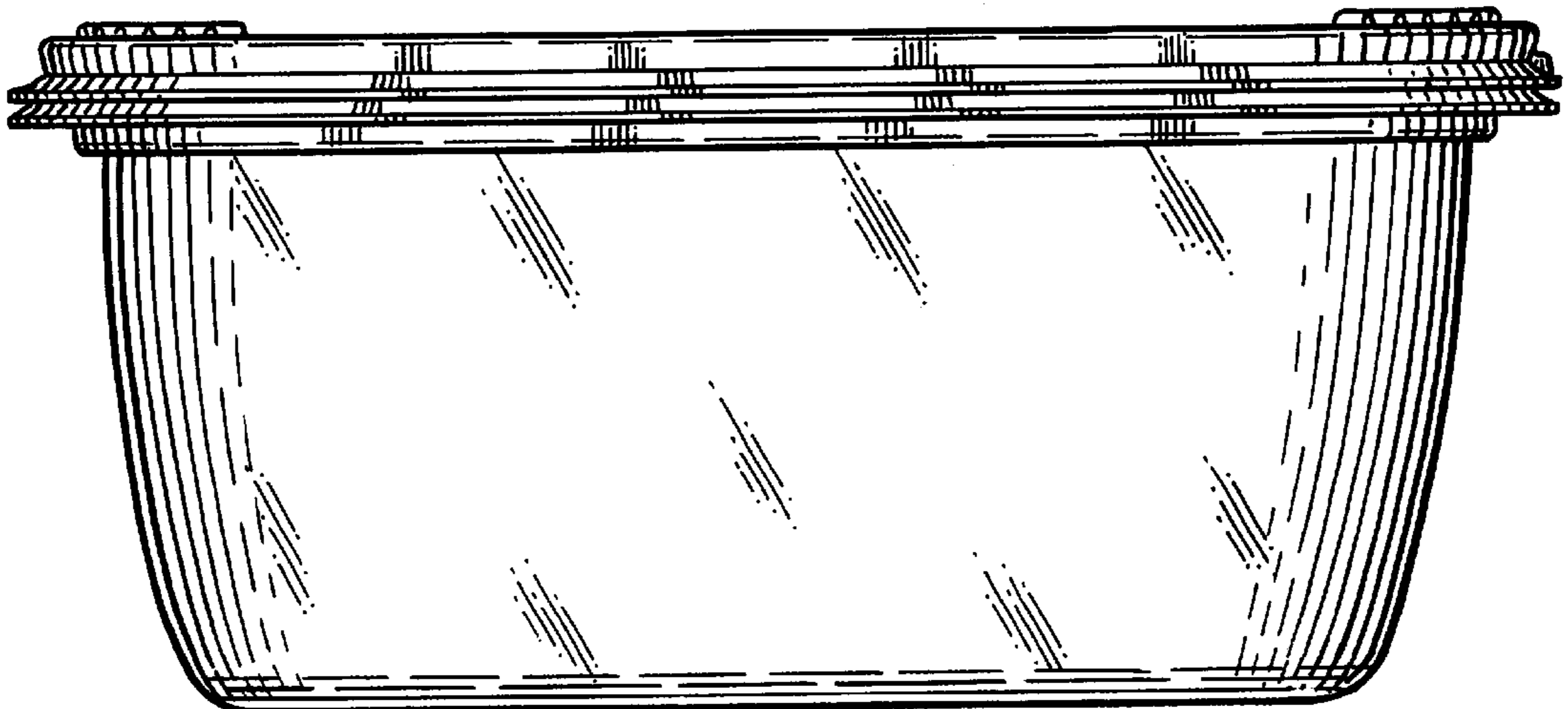

Fig.5

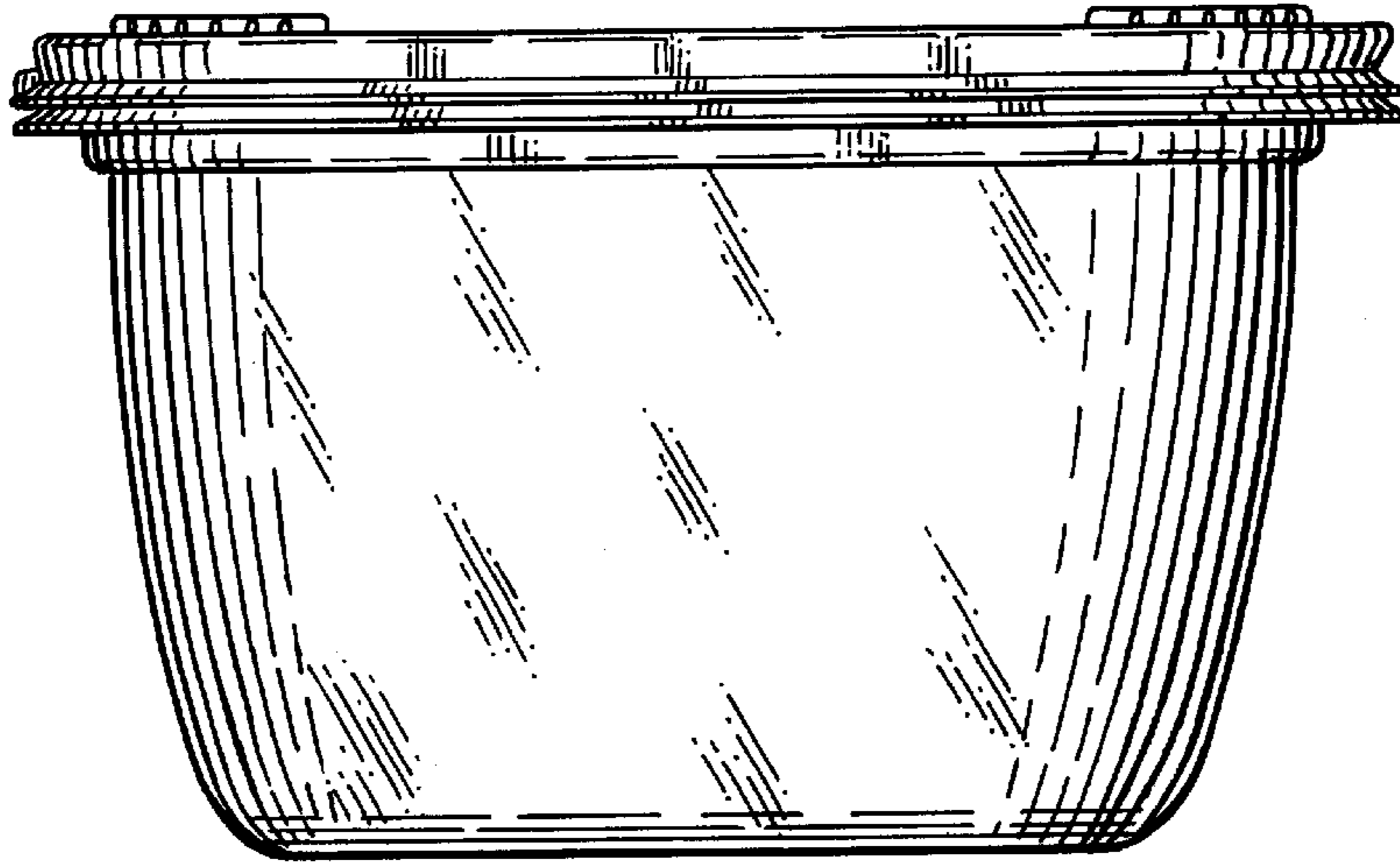

Fig.6

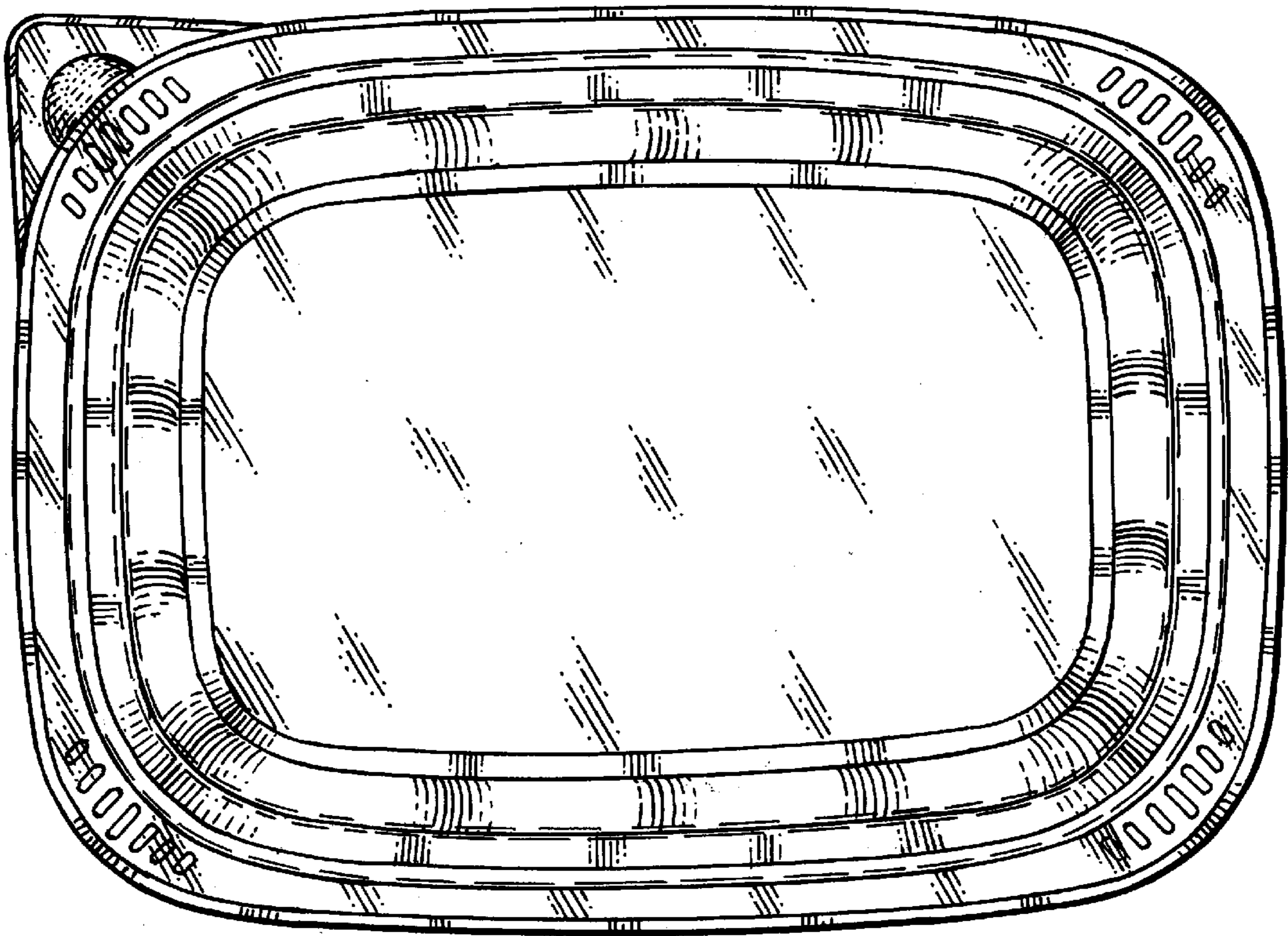

Fig.7