



US00D445622S

(12) **United States Design Patent**
Fenichel

(10) **Patent No.:** **US D445,622 S**

(45) **Date of Patent:** **** Jul. 31, 2001**

(54) **PILLOW**

D. 338,633 * 8/1993 Andre D11/96

(76) **Inventor:** **Tamara Lee Fenichel**, 3045 Bow
Creek Blvd., Virginia Beach, VA (US)
23452

* cited by examiner

Primary Examiner—Janice E. Seeger

(**) **Term:** **14 Years**

(57) **CLAIM**

The ornamental design for the pillow, as shown.

(21) **Appl. No.:** **29/131,271**

(22) **Filed:** **Oct. 17, 2000**

DESCRIPTION

(51) **LOC (7) Cl.** **06-09**

FIG. 1 is a front perspective view of a pillow showing my new design;

(52) **U.S. Cl.** **D6/597; D99/27**

FIG. 2 is a rear view thereof; and

(58) **Field of Search** D6/595, 596, 601,
D6/604; 5/630, 631, 633, 636, 637, 652,
653, 654, 655.3, 655.9, 907; D11/96; D99/27,
25

FIG. 3 is a left angled view thereof; and

FIG. 4 is a right angled view thereof; and

FIG. 5 is a bottom up angled view thereof; and,

FIG. 6 is a top down angled view thereof.

(56) **References Cited**

U.S. PATENT DOCUMENTS

D. 186,128 * 9/1959 Franzone D11/96

1 Claim, 1 Drawing Sheet

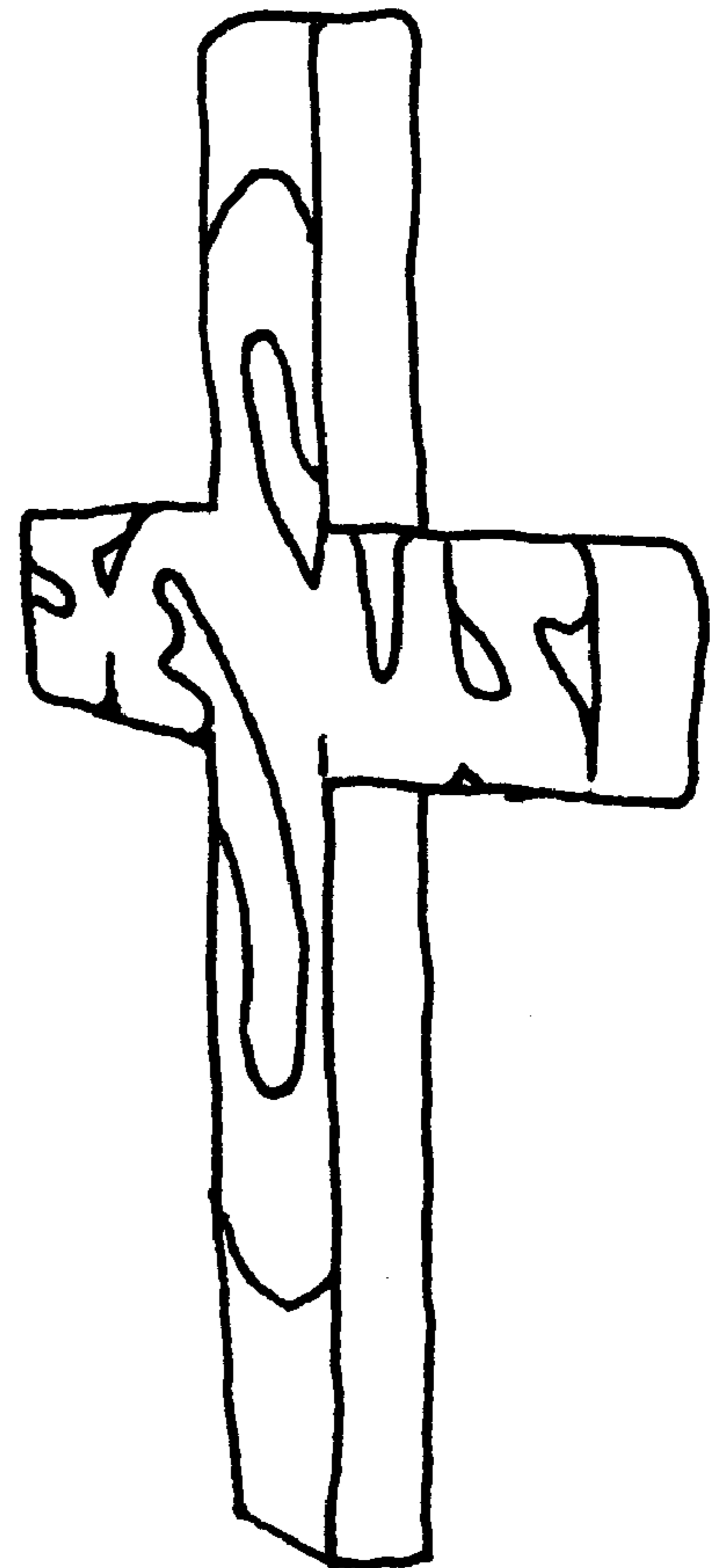
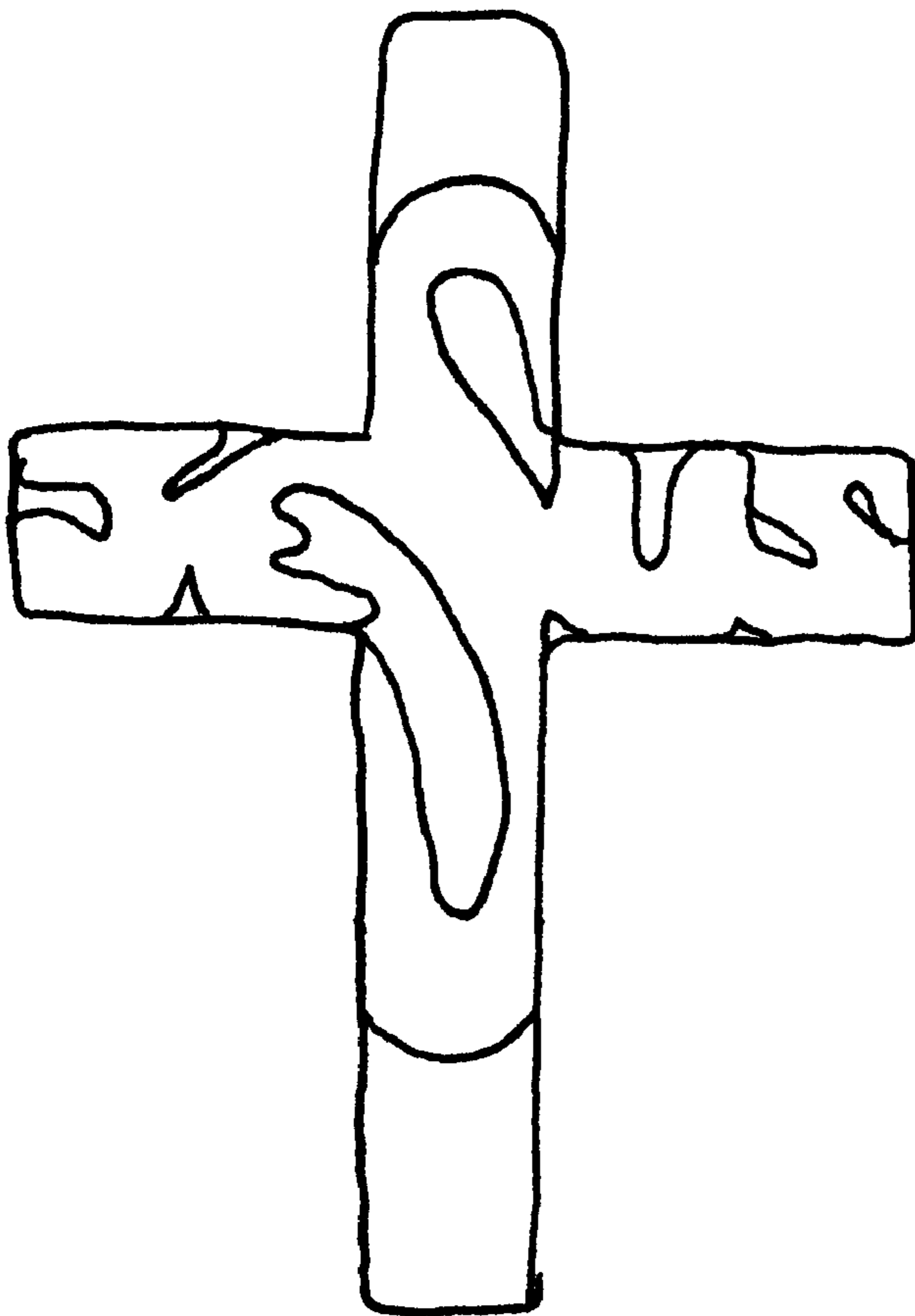

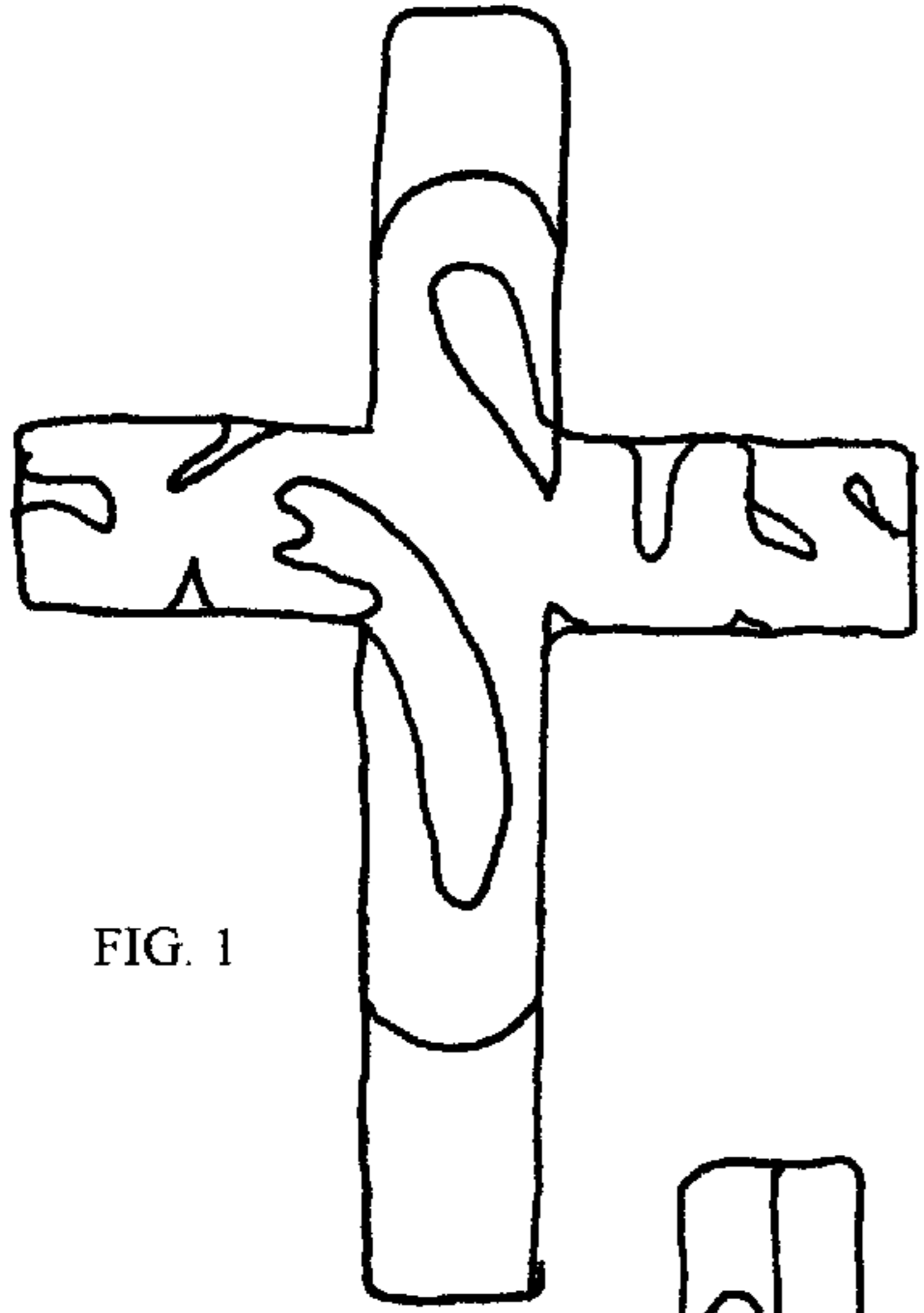

FIG. 1

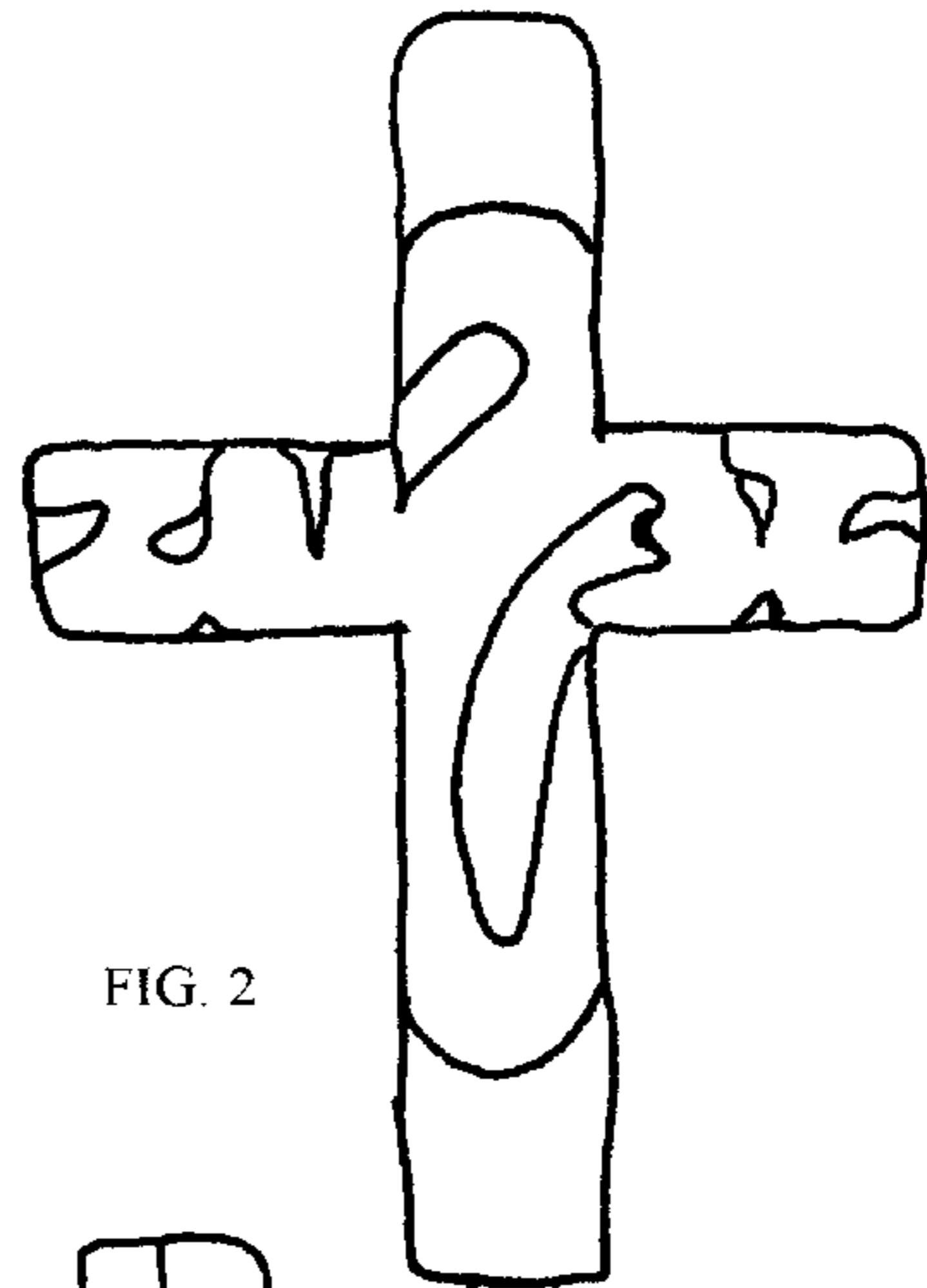

FIG. 2

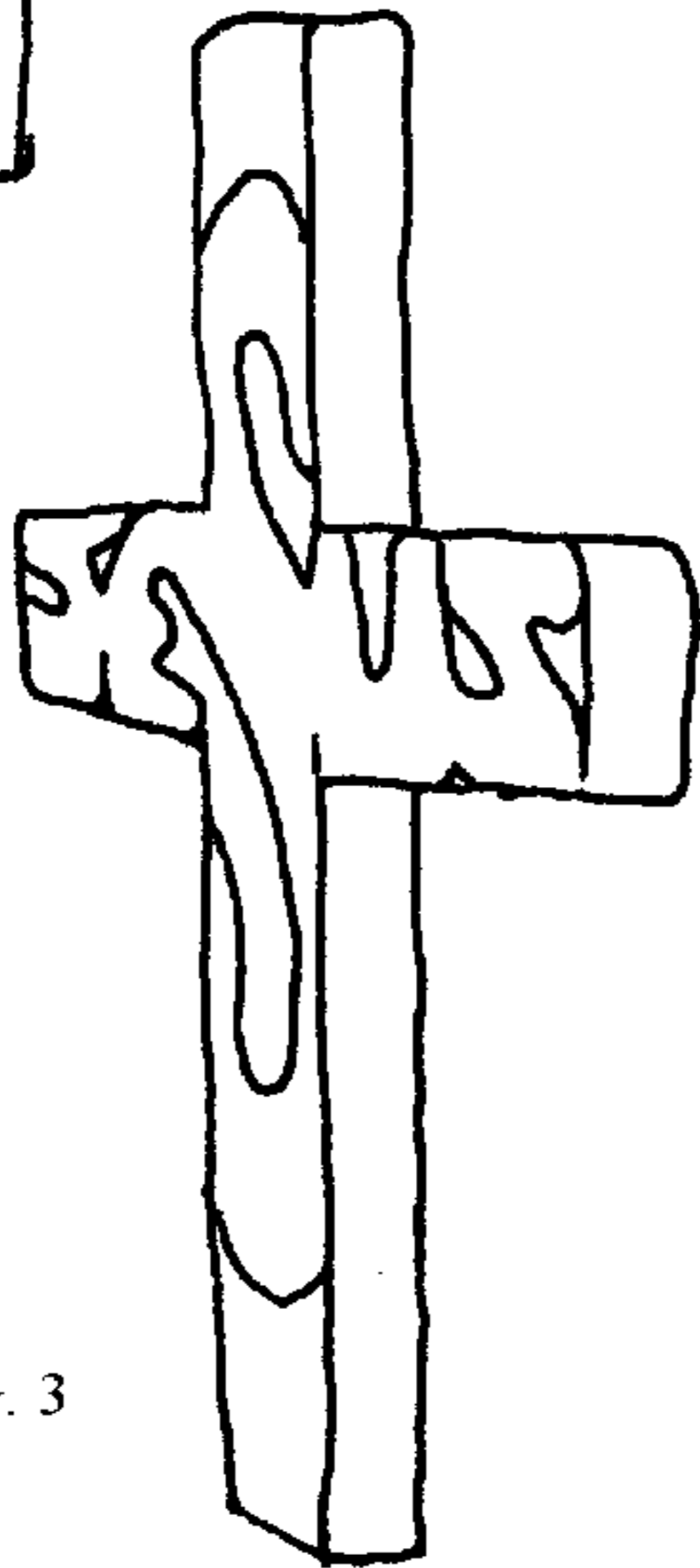

FIG. 3

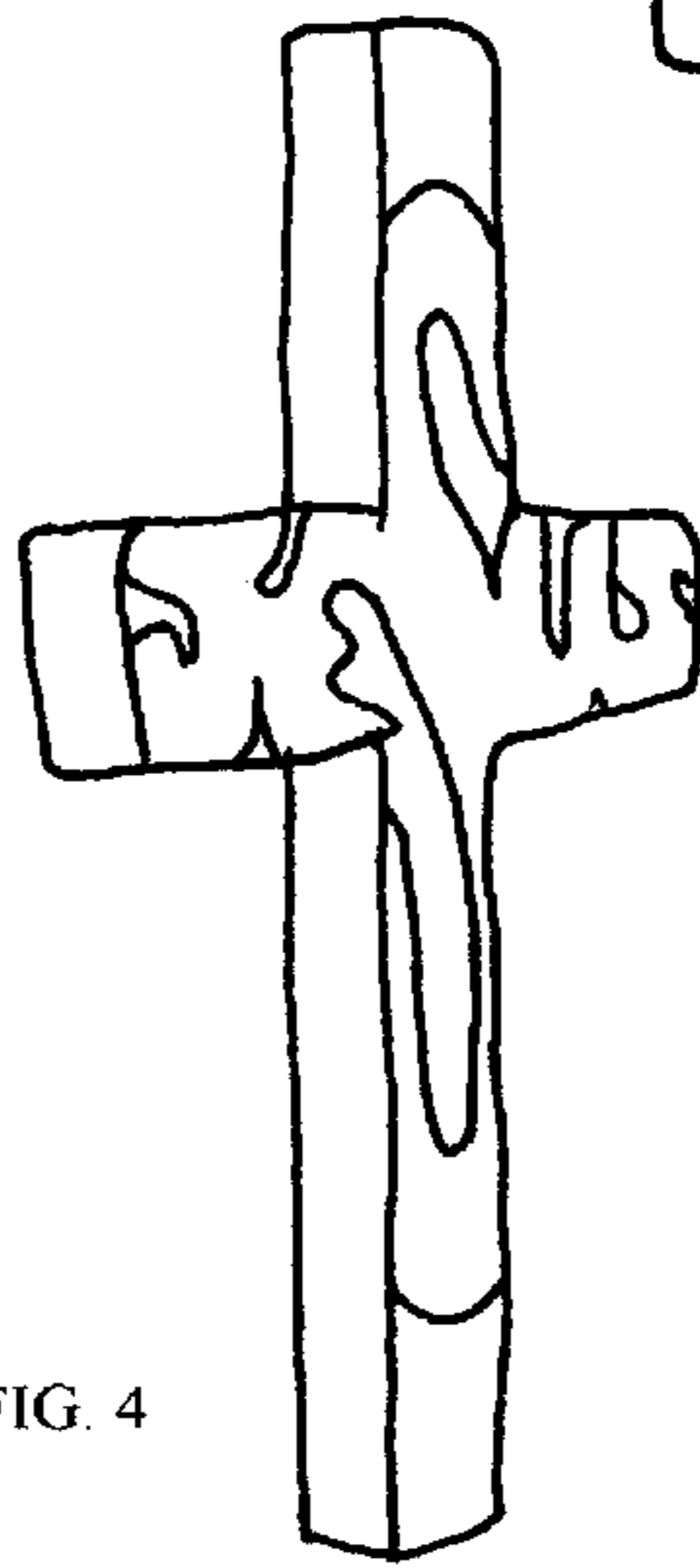

FIG. 4

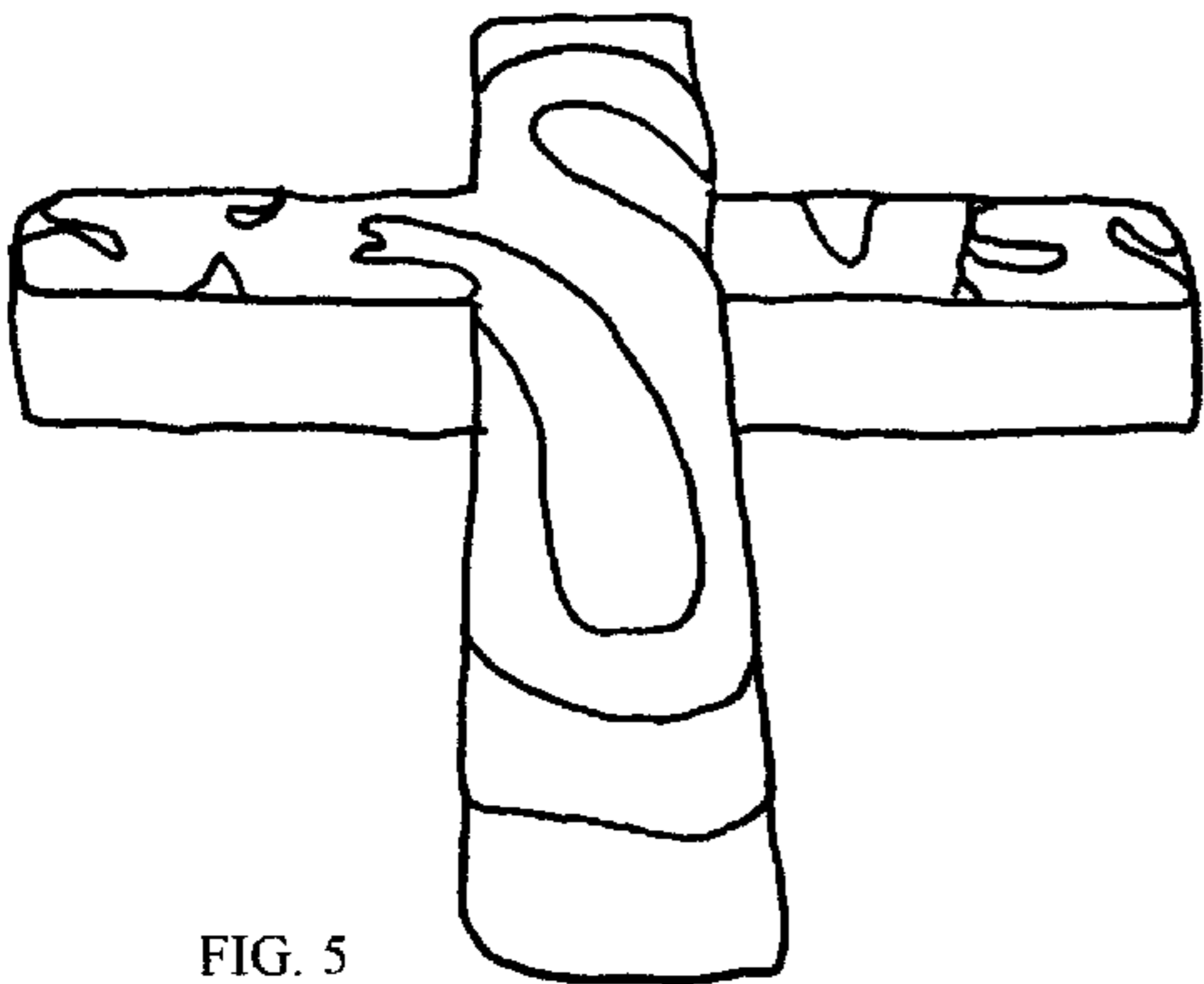

FIG. 5

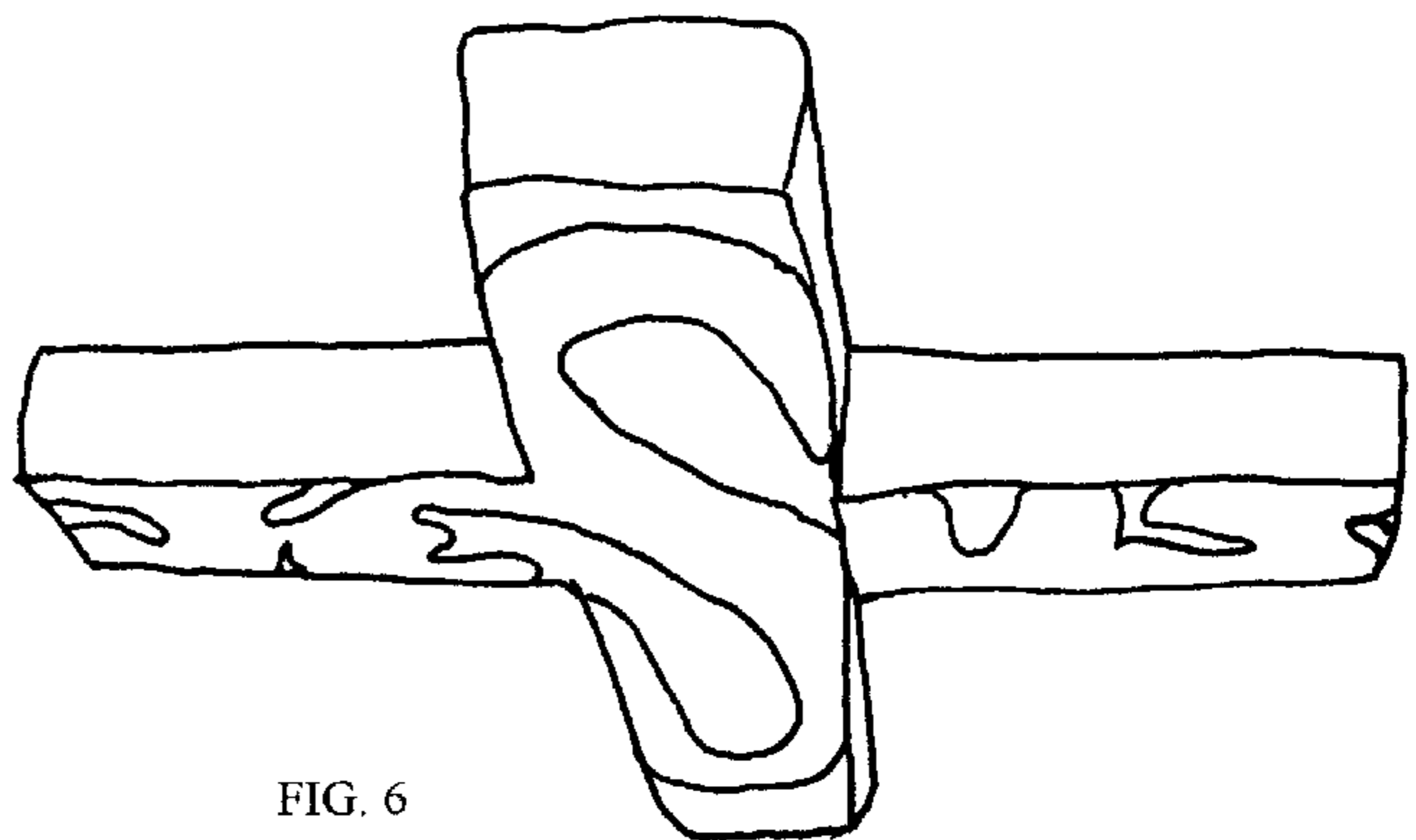

FIG. 6