



US00D445549S

(12) **United States Design Patent**
Griffin

(10) **Patent No.:** **US D445,549 S**

(45) **Date of Patent:** **** Jul. 24, 2001**

(54) **TANK FOR A VACUUM CLEANER**

(75) Inventor: **John Griffin**, Phoenix, AZ (US)

(73) Assignee: **Shop Vac Corporation**, Williamsport, PA (US)

(**) Term: **14 Years**

(21) Appl. No.: **29/115,798**

(22) Filed: **Dec. 20, 1999**

(51) **LOC (7) Cl.** **15-05**

(52) **U.S. Cl.** **D32/31**

(58) **Field of Search** D32/21, 23, 25,
D32/31; D34/23, 27; 15/320-321, 327.1,
327.2, 327.3, 327.4, 327.6, 327.7, 339,
323, 325, 410, 352

(56) **References Cited**

U.S. PATENT DOCUMENTS

D. 286,336	*	10/1986	Berfield et al.	D32/23
D. 287,171		12/1986	Berfield et al.	32/25
D. 315,624		3/1991	Kimura et al.	32/23
D. 357,336		4/1995	Moine et al.	32/23
D. 357,773	*	4/1995	Wareham et al.	D32/23
D. 358,010		5/1995	Berfield et al.	32/23
D. 361,179		8/1995	Moine et al.	32/23
D. 362,091	*	9/1995	Tomasiak et al.	D32/23
D. 372,567		8/1996	Moine et al.	32/23
D. 373,862		9/1996	Stephens et al.	32/23
D. 374,523	*	10/1996	Tomasiak	D32/31
D. 383,575		9/1997	Griffin	32/23
D. 384,448		9/1997	Stephens et al.	32/23
D. 388,565		12/1997	Pietrobon	32/23
D. 389,962		1/1998	Berfield et al.	32/23
D. 395,119		6/1998	Berfield	34/23
D. 429,394	*	8/2000	Griffin et al.	D32/31
D. 430,367	*	8/2000	Griffin	D32/23
2,920,337		1/1960	Smith	15/323
5,144,716		9/1992	Watanabe et al.	15/323
5,528,794	*	6/1996	Tomasiak	15/323
5,535,500	*	7/1996	Stephens et al.	29/453

OTHER PUBLICATIONS

Shop-Vac Brochure, QSP Series—Quiet Super Power Wet/Dry Vacs, Model Nos. 900-80 thru 900-84, dated Aug. 1993.

Shop-Vac Brochure, 707 Series Super Performance Wet/Dry Vacs, Model No. 707-10, dated Mar. 1991.

Shop-Vac Brochure, QSP Series—Quiet Super Power Wet/Dry Vacs, Models 900-86 and 900-87, dated Aug. 1993.

(List continued on next page.)

Primary Examiner—Ruth McInroy

(74) *Attorney, Agent, or Firm*—Marshall, O'Toole, Gerstein, Murray & Borun

(57) **CLAIM**

The ornamental design for a tank for a vacuum cleaner, as shown and described.

DESCRIPTION

FIG. 1 is a top, front and left side perspective view of a tank for a vacuum cleaner showing my new design;

FIG. 2 is a top, rear and right side perspective view thereof;

FIG. 3 is a front elevational view thereof;

FIG. 4 is a rear elevational view thereof;

FIG. 5 is a right side elevational view thereof, the left side being a mirror image thereof;

FIG. 6 is a top plan view thereof;

FIG. 7 is a top, front and left side perspective view of a second embodiment thereof;

FIG. 8 is a top, rear and right side perspective view of FIG. 7;

FIG. 9 is a front elevational view of FIG. 7;

FIG. 10 is a rear elevational view of FIG. 7;

FIG. 11 is a right side elevational view of FIG. 7, the left side being a mirror image thereof; and,

FIG. 12 is a top plan view of FIG. 7.

The broken line showing of a motor cover for a vacuum cleaner is for illustrative purposes only and forms no part of the claimed design.

1 Claim, 12 Drawing Sheets

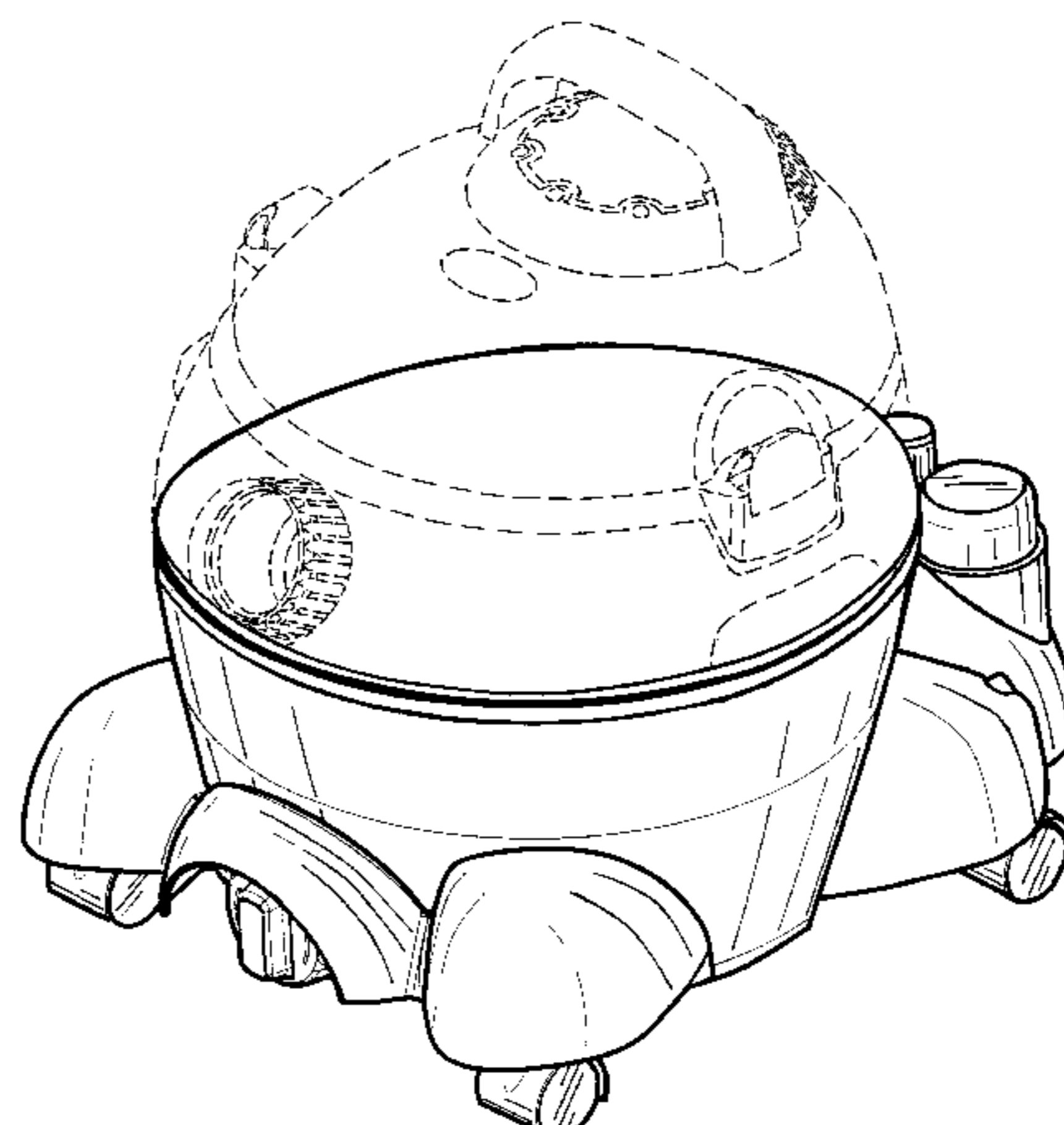
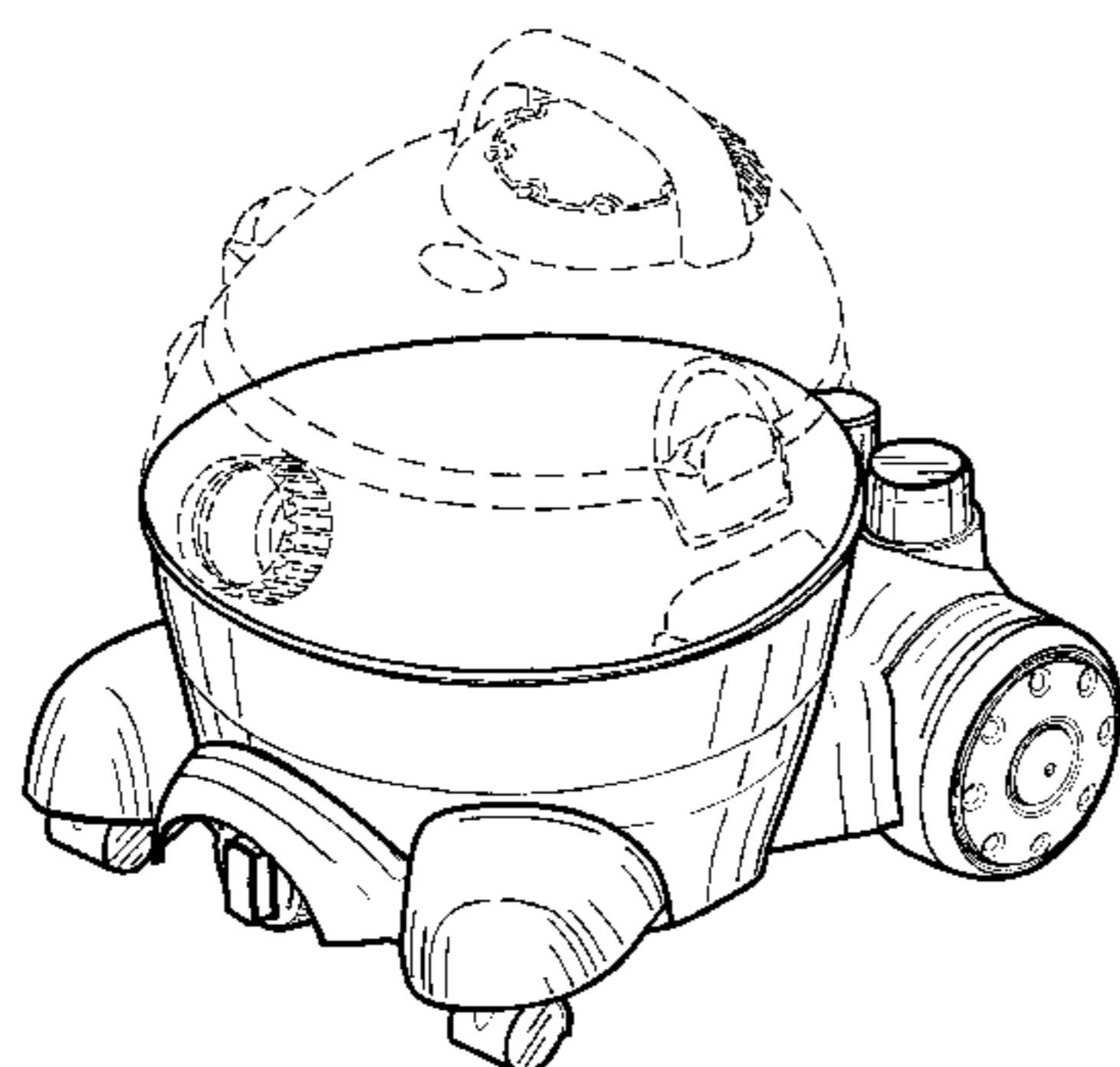

OTHER PUBLICATIONS

Shop-Vac Brochure, QSP Series—Quiet Super Power Wet/Dry Vacs, Model No. 900-29, dated Aug. 1993.

Shop-Vac Brochure, Series 914—Quiet Super Performance Wet/Dry Vacs, Model Nos. 914-15 and 914-27, dated Apr. 1997.

Shop-Vac Brochure, Floormaster, Wet & Dry Cleaning System, Model No. 909-50, dated Jan. 1989.

Shop-Vac Brochure, The QSP Line of Wet/Dry Vacs from Shop Vac, dated 1994.

Shop-Vac Brochure, All Around Vac, dated 1997.

Shop-Vac Brochure, QSP Pro, dated 1998.

Shop-Vac Brochure, QPV, dated 1997.

Shop-Vac Brochure, 1X1 Wet/Dry Vac, dated 1997.

Karcher Brochure, High Performance Wet and Dry Vacuums, Dust Extraction and Spray Extraction Machines.

* cited by examiner

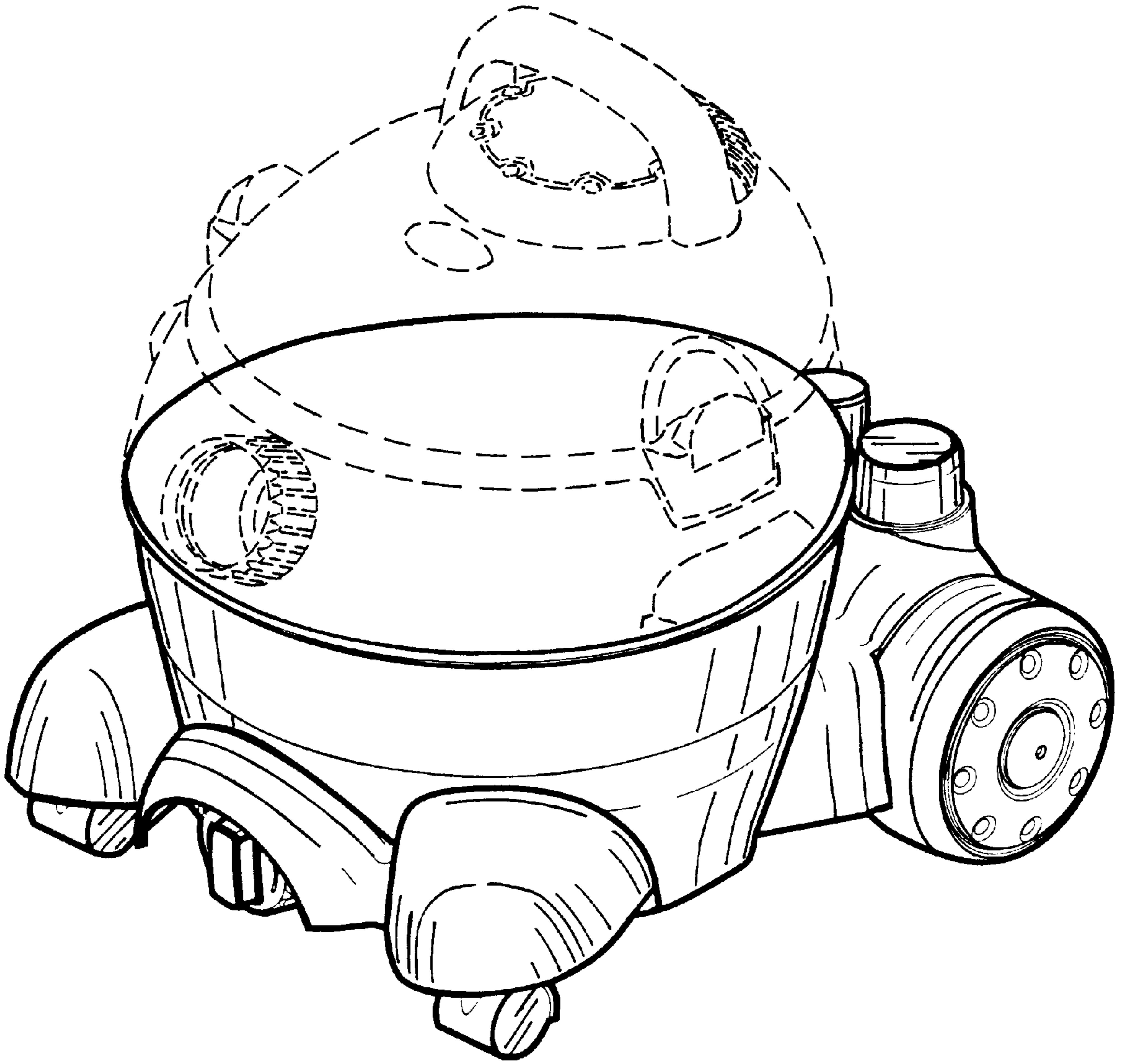

Fig. 1

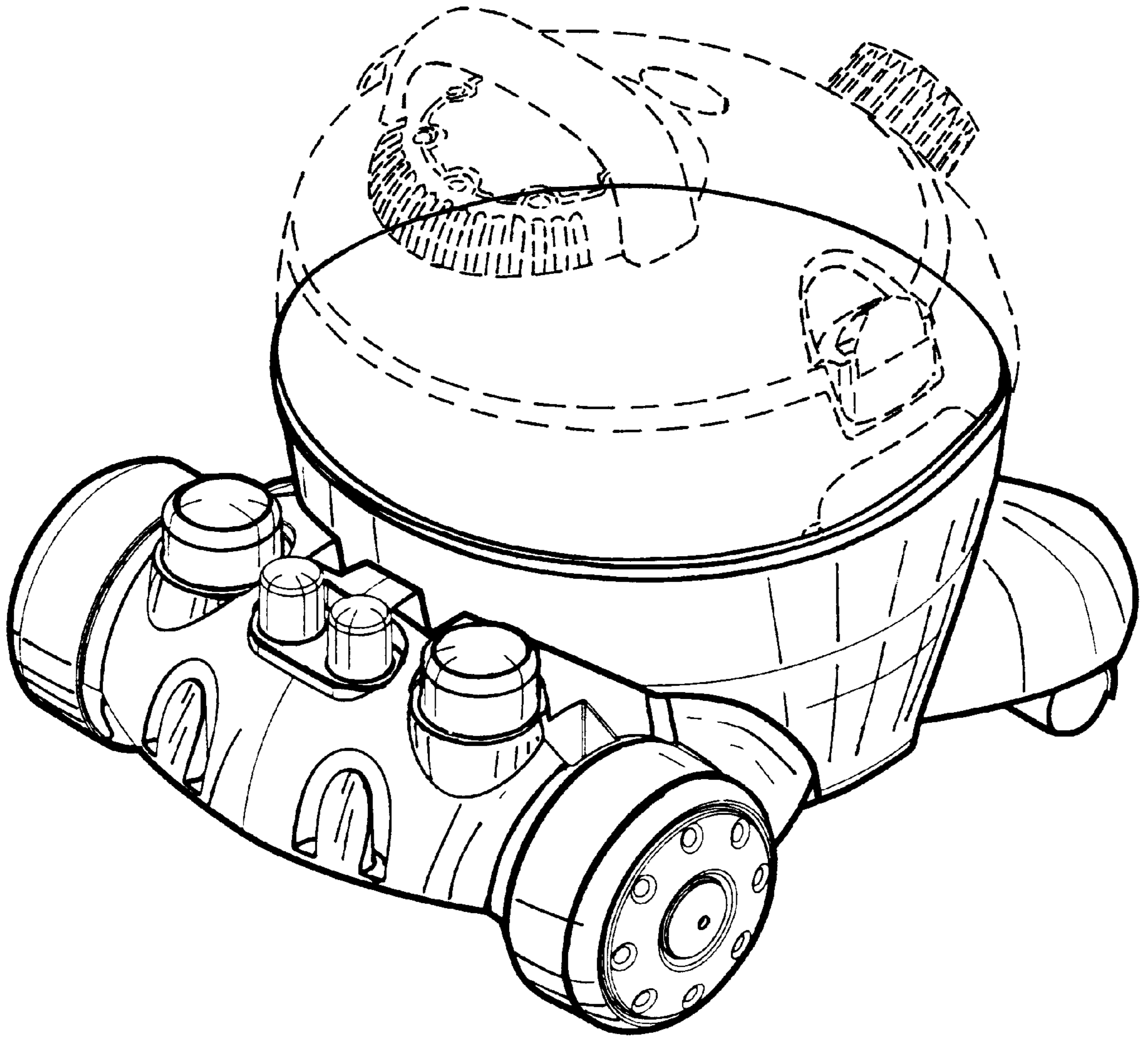

Fig. 2

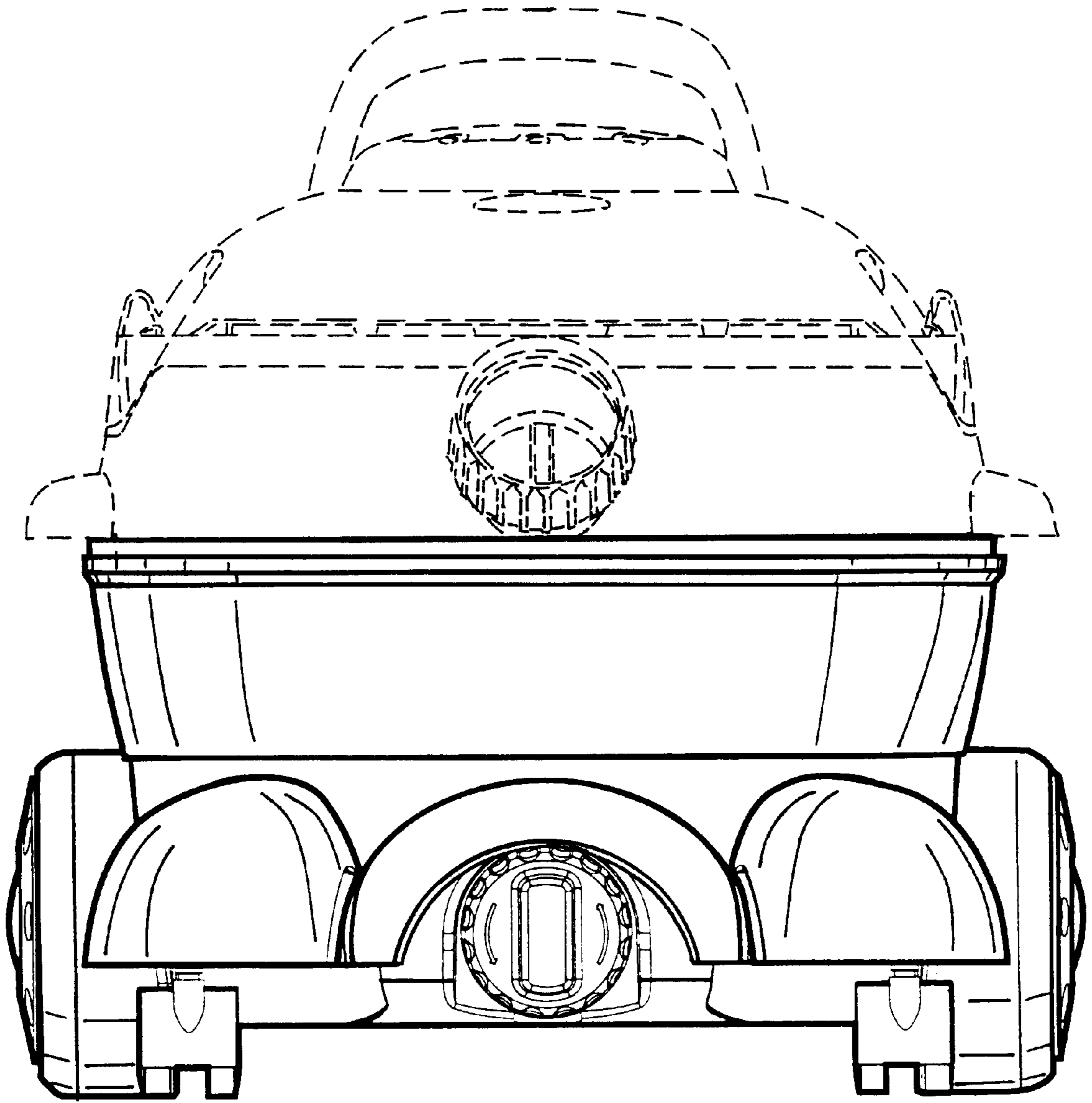

Fig. 3

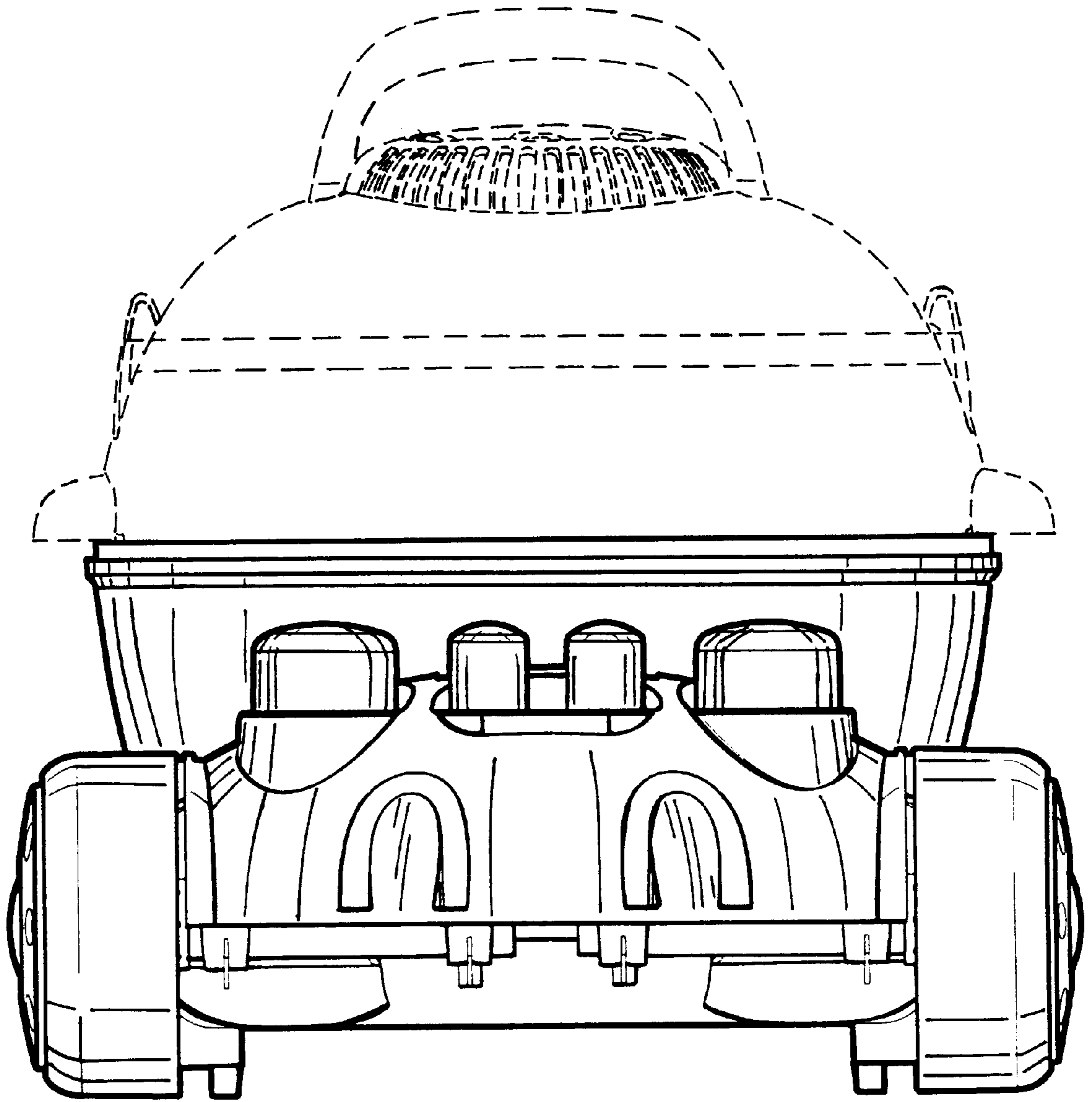

Fig. 4

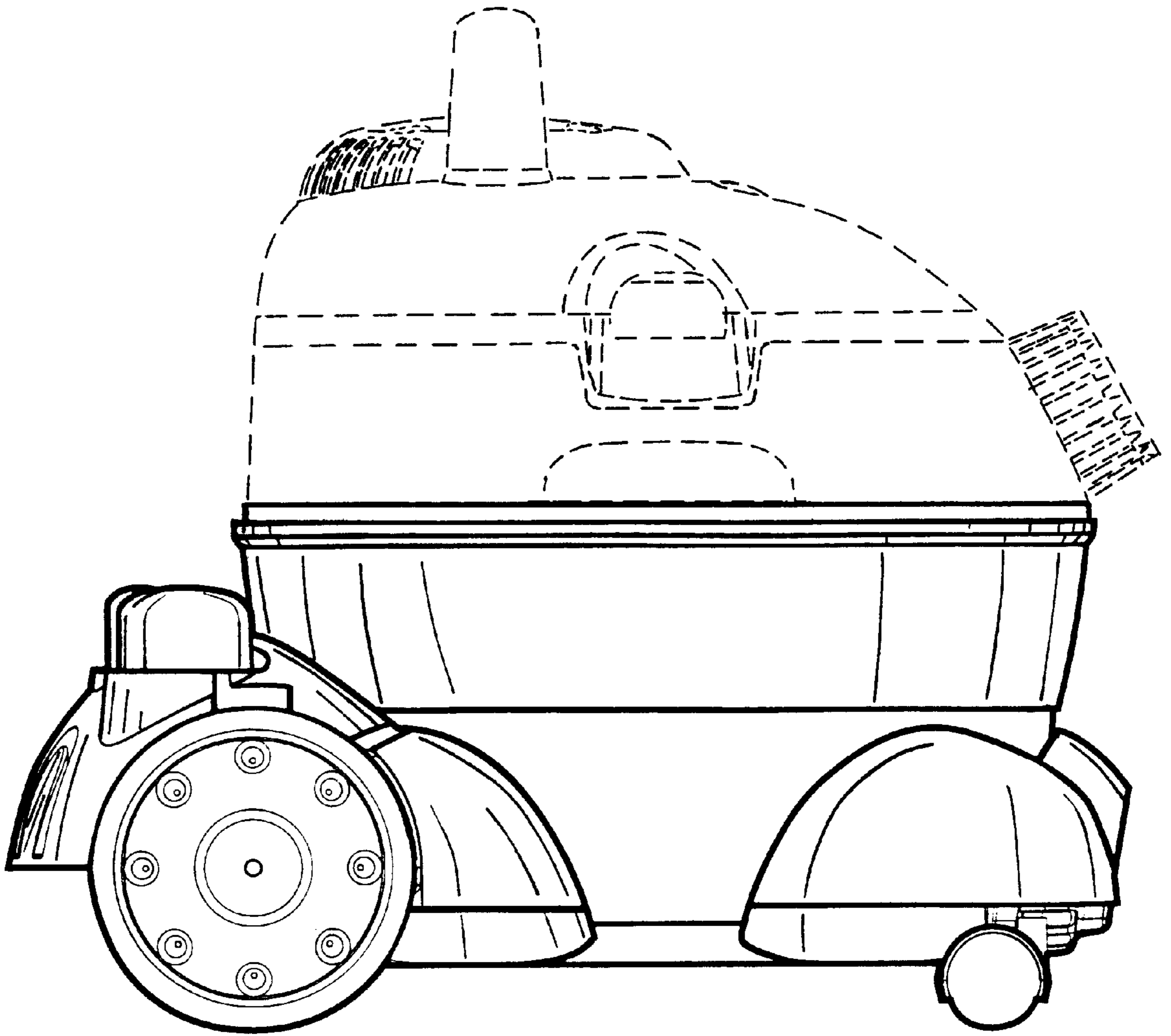

Fig. 5

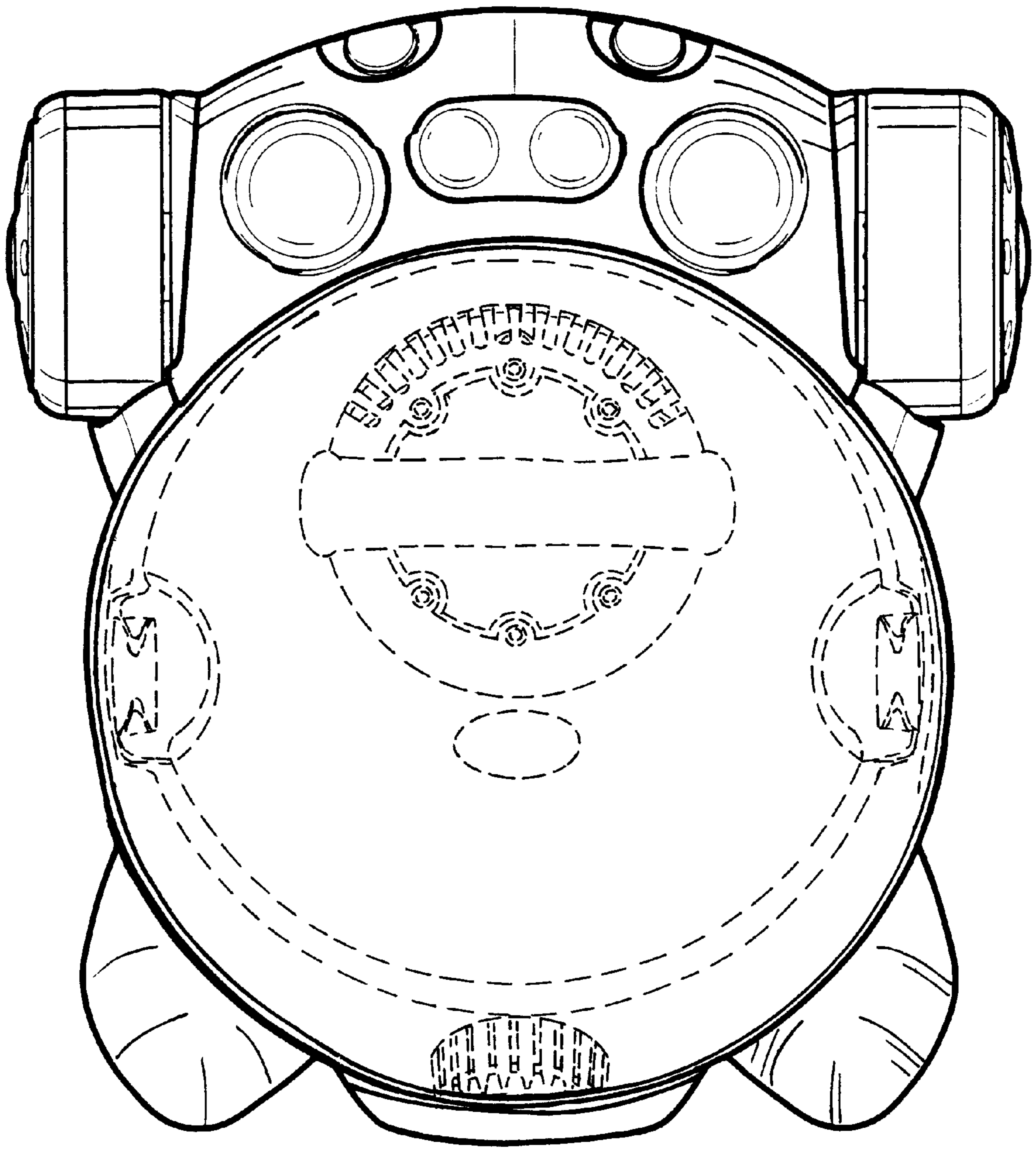

Fig. 6

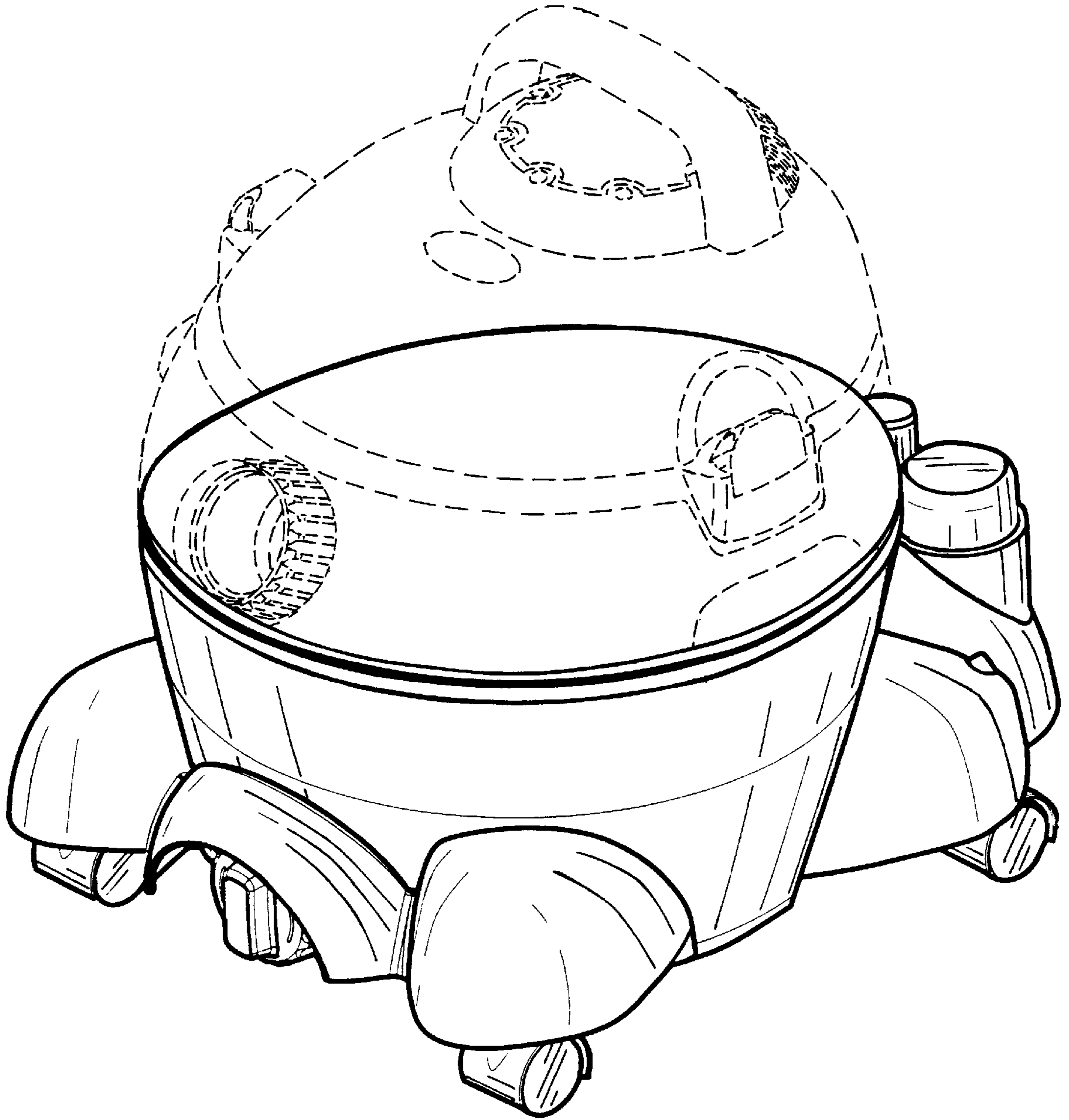

Fig. 7

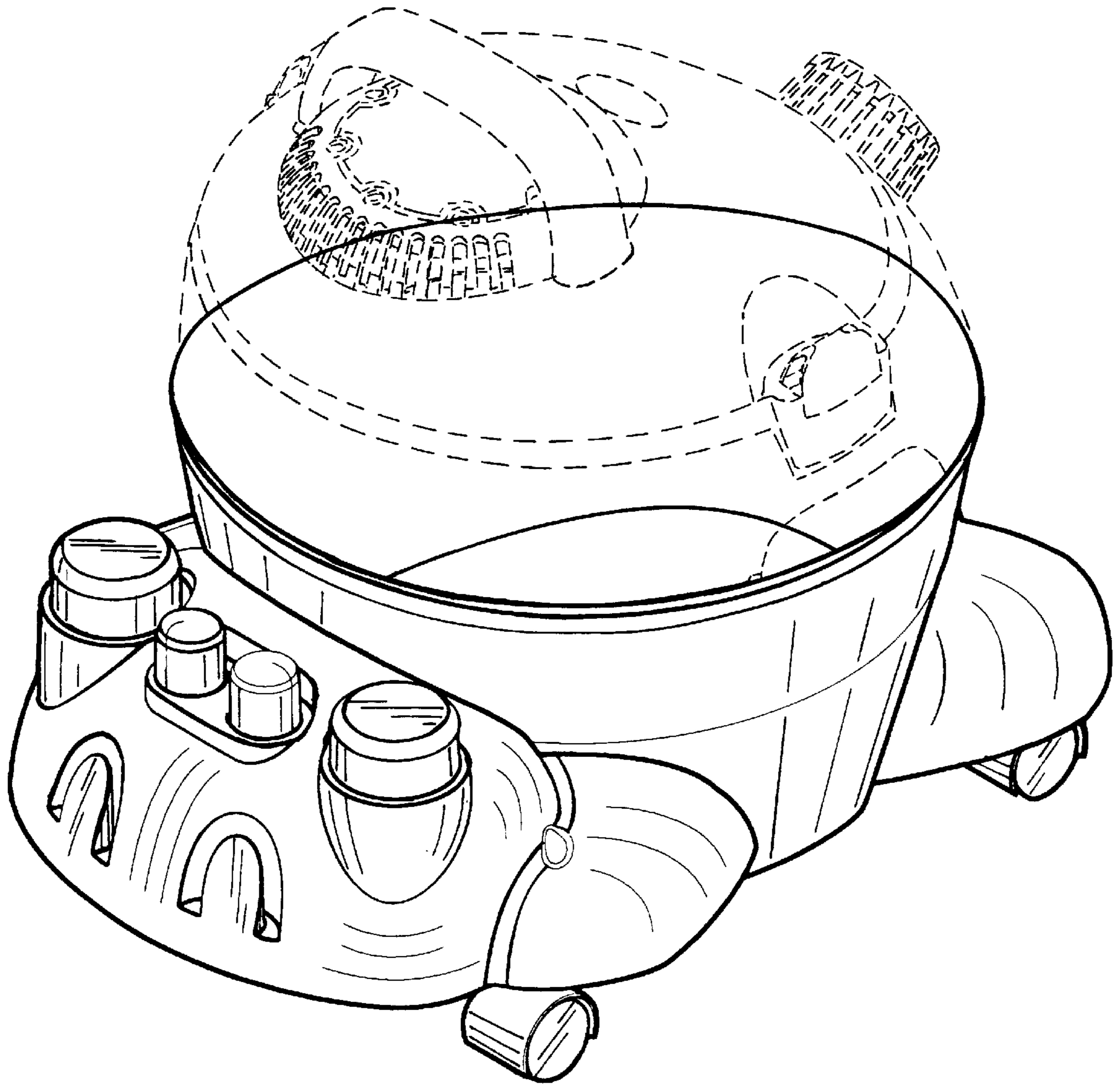

Fig. 8

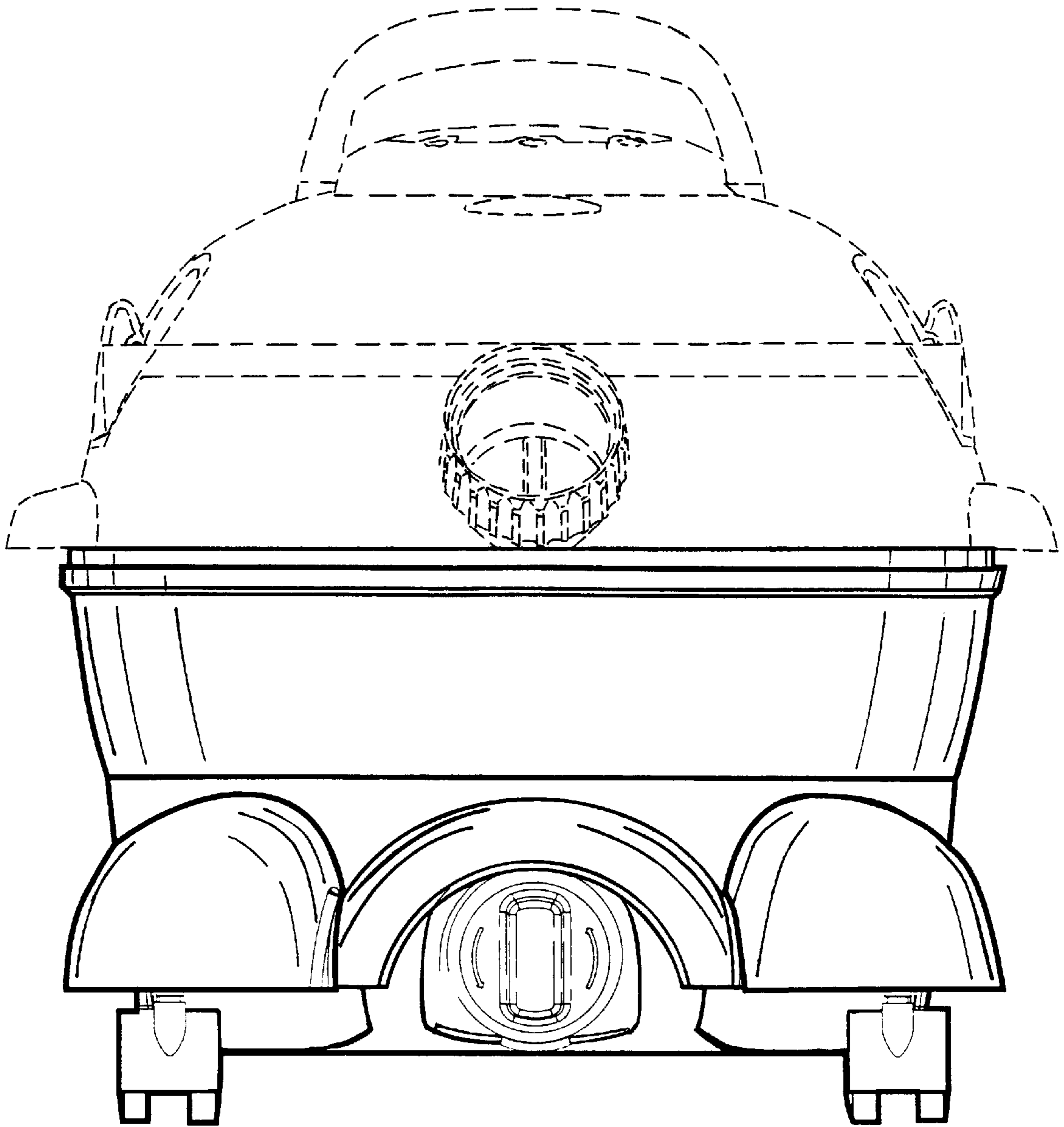

Fig. 9

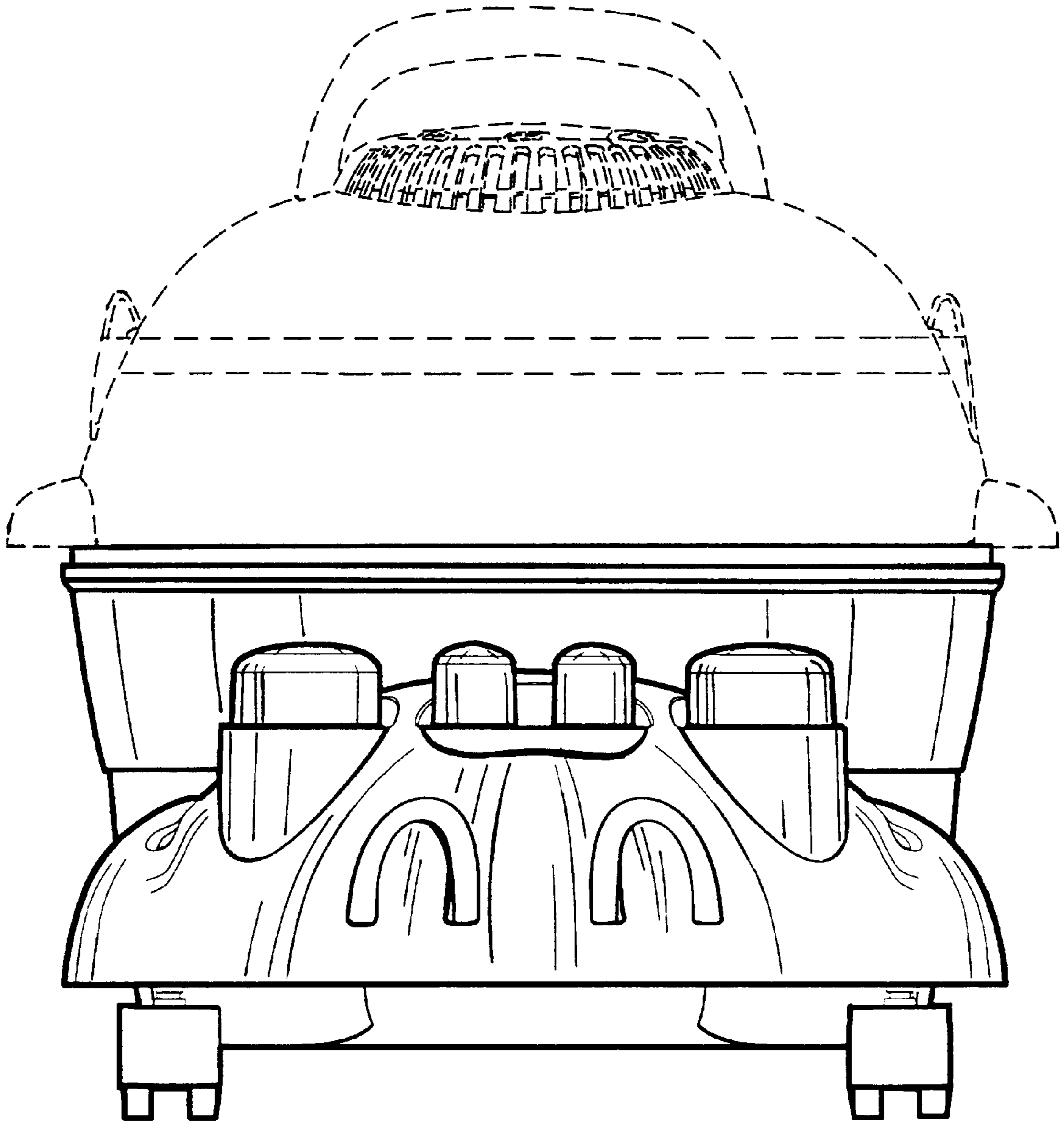

Fig. 10

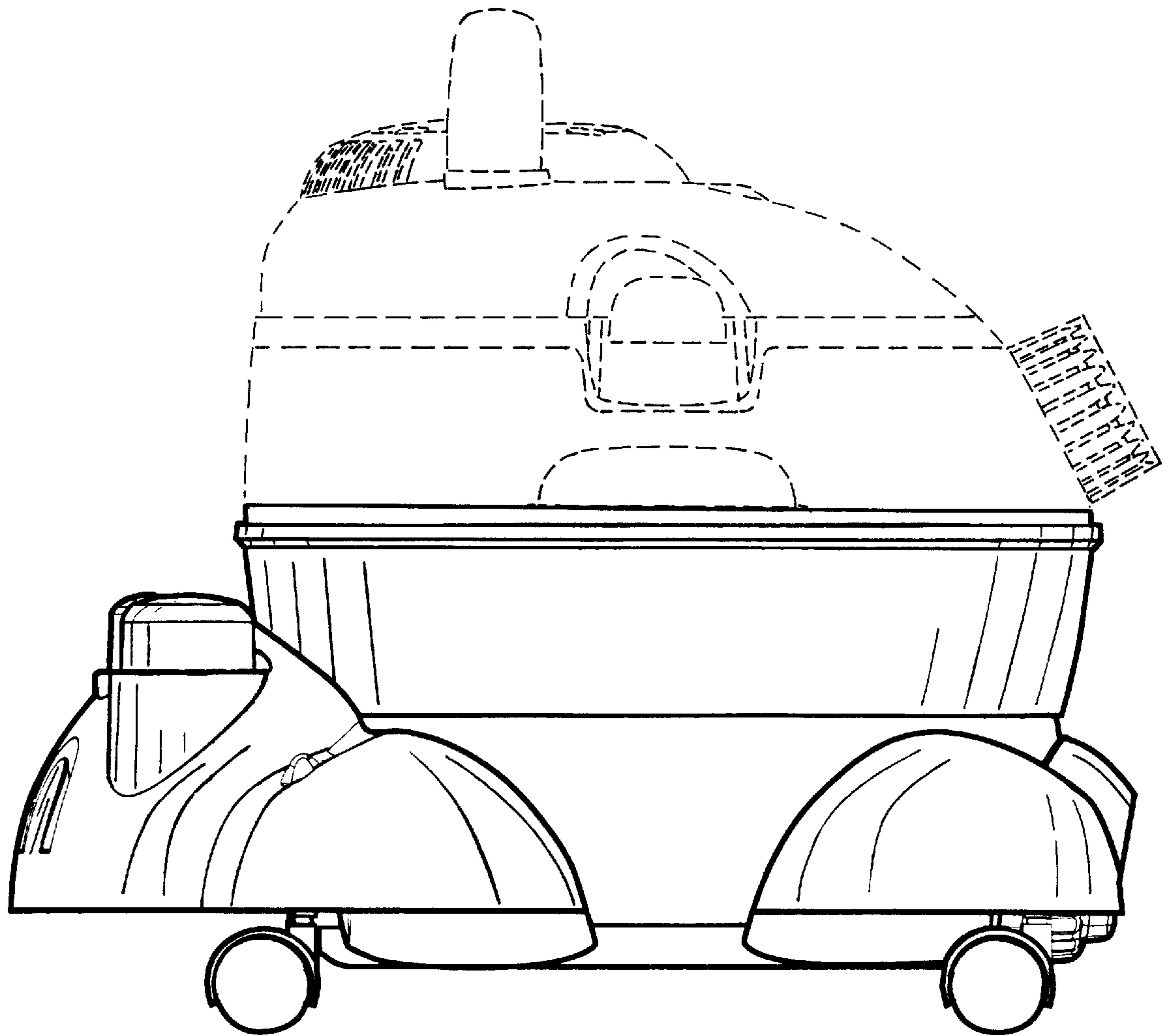

Fig. 11

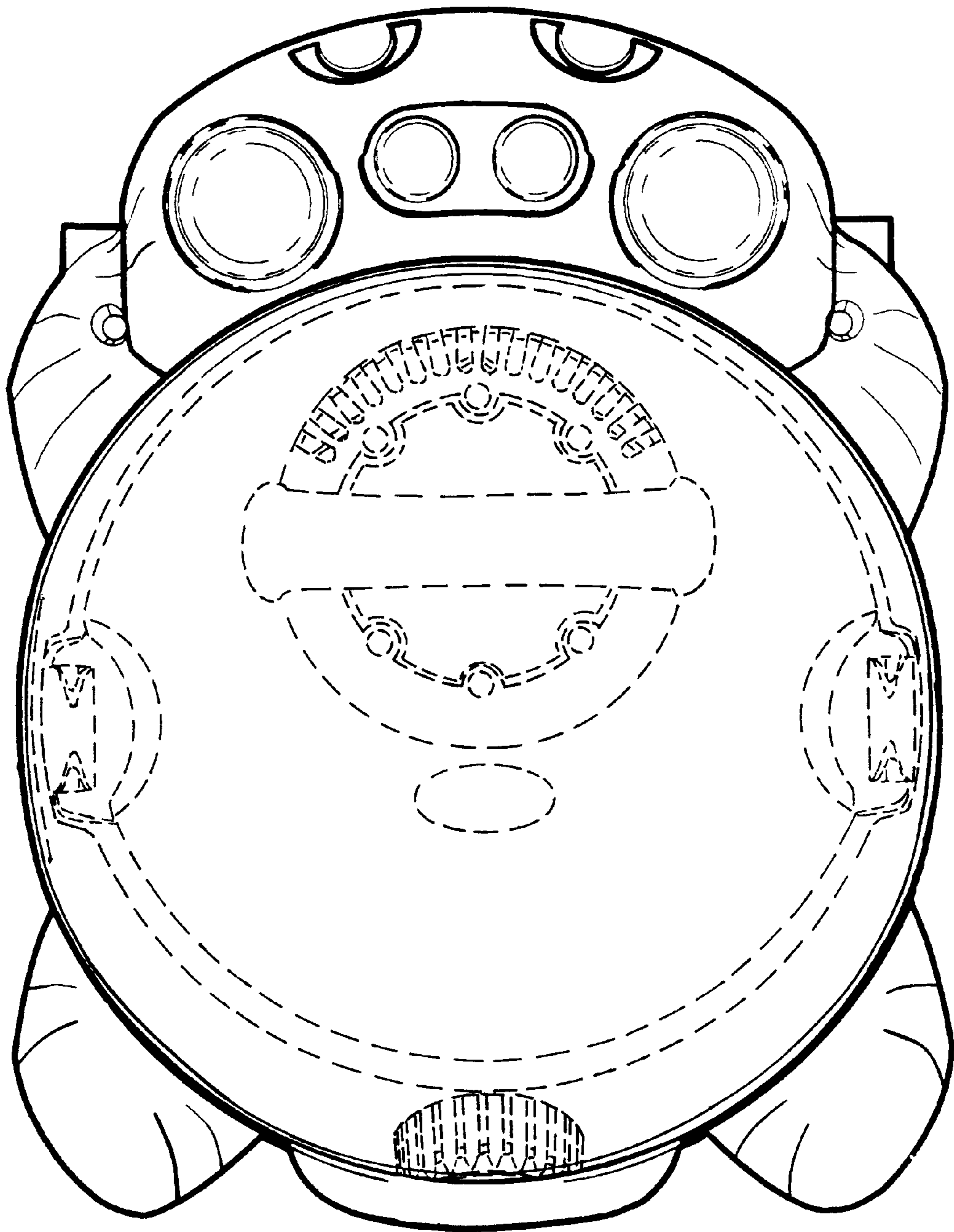

Fig. 12