



US00D445548S

(12) **United States Design Patent**
Griffin

(10) **Patent No.:** **US D445,548 S**

(45) **Date of Patent:** **** Jul. 24, 2001**

(54) **VACUUM CLEANER**

(75) Inventor: **John Griffin**, Phoenix, AZ (US)

(73) Assignee: **Shop Vac Corporation**, Williamsport, PA (US)

(*) Notice: This patent is subject to a terminal disclaimer.

(**) Term: **14 Years**

(21) Appl. No.: **29/097,456**

(22) Filed: **Dec. 7, 1998**

(51) **LOC (7) Cl.** **15-05**

(52) **U.S. Cl.** **D32/21**

(58) **Field of Search** D32/21, 23-25,
D32/31; 15/327.1, 327.2, 327.4, 320-321,
323, 352, 353, 347, 328

(56) **References Cited**

U.S. PATENT DOCUMENTS

D. 287,171	12/1986	Berfield et al.	32/25
D. 315,624	* 3/1991	Kimura et al.	D32/23
D. 357,336	* 4/1995	Moine et al.	D32/23
D. 357,773	* 4/1995	Wareham et al.	D32/23
D. 358,010	5/1995	Berfield et al.	32/23
D. 361,179	* 8/1995	Moine et al.	D32/23
D. 362,091	* 9/1995	Tomasiak et al.	D32/23
D. 372,567	* 8/1996	Moine et al.	D32/23
D. 373,862	* 9/1996	Stephens et al.	D32/23
D. 383,575	* 9/1997	Griffin	D32/23
D. 384,448	* 9/1997	Stephens et al.	D32/23
D. 388,565	* 12/1997	Pietrobon	D32/23
D. 389,962	1/1998	Berfield et al.	32/23
D. 395,119	6/1998	Berfield	34/23
2,920,337	1/1960	Smith	15/323
5,144,716	9/1992	Watanabe et al.	15/323

OTHER PUBLICATIONS

SHOP-VAC Brochure, 707 Series Super Performance Wet/Dry Vacs, Model No. 707-10, dated Mar. 1991.

SHOP-VAC Brochure, QSP Series—Quiet Super Power Wet/Dry Vacs, Models 900-86 and 900-87, dated Aug. 1993.

SHOP-VAC Brochure, QSP Series—Quiet Super Power Wet/Dry Vacs, Model No. 900-29, dated Aug. 1993.

SHOP-VAC Brochure, Series 914—Quiet Super Performance Wet/Dry Vacs, Model Nos. 914-15 and 914-27, dated Apr. 1997.

SHOP-VAC Brochure, FLOORMASTER, Wet & Dry Cleaning System, Model No. 909-50, dated Jan. 1989.

SHOP-VAC Brochure, The QSP Line of Wet/Dry Vacs from Shop Vac, dated 1994.

SHOP-VAC Brochure, ALL AROUND Vac, dated 1997.

SHOP-VAC Brochure, QSP PRO, dated 1998.

SHOP-VAC Brochure, QPV, dated 1997.

SHOP-VAC Brochure, 1X1 Wet/Dry Vac, dated 1997.

Karcher Brochure, High Performance Wet and Dry Vacuums, Dust Extraction and Spray Extraction Machines no date.

* cited by examiner

Primary Examiner—Ruth McInroy

(74) *Attorney, Agent, or Firm*—Marshall, O'Toole, Gerstein, Murray & Borun

(57) **CLAIM**

The ornamental design for a vacuum cleaner, as shown and described.

DESCRIPTION

FIG. 1 is a perspective view of a vacuum cleaner showing my new design;

FIG. 2 is a front elevational view thereof;

FIG. 3 is a back elevational view thereof;

FIG. 4 is a left elevational view thereof;

FIG. 5 is a right elevational view thereof;

FIG. 6 is a top plan view thereof; and,

FIG. 7 is a bottom view thereof.

1 Claim, 7 Drawing Sheets

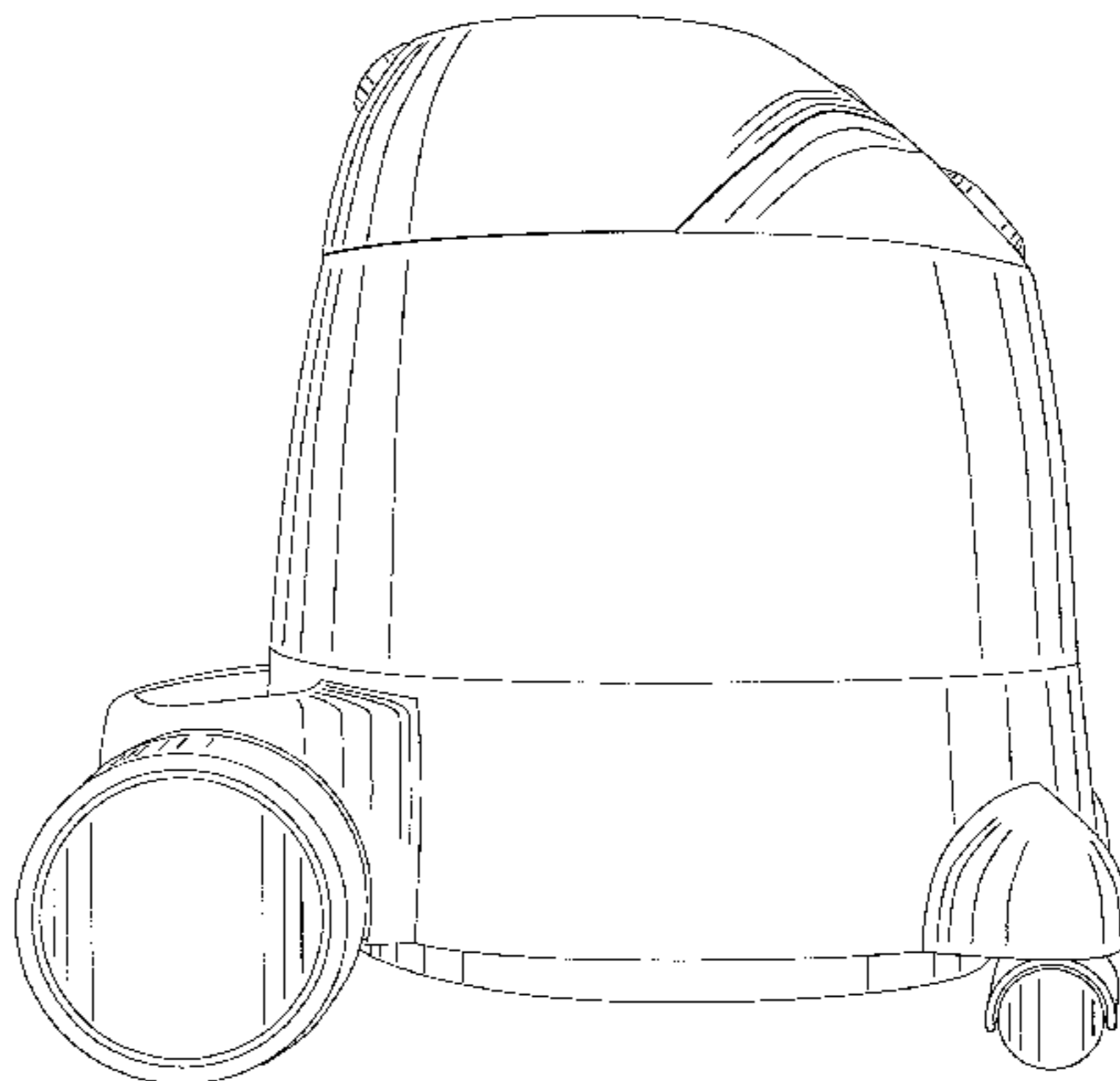
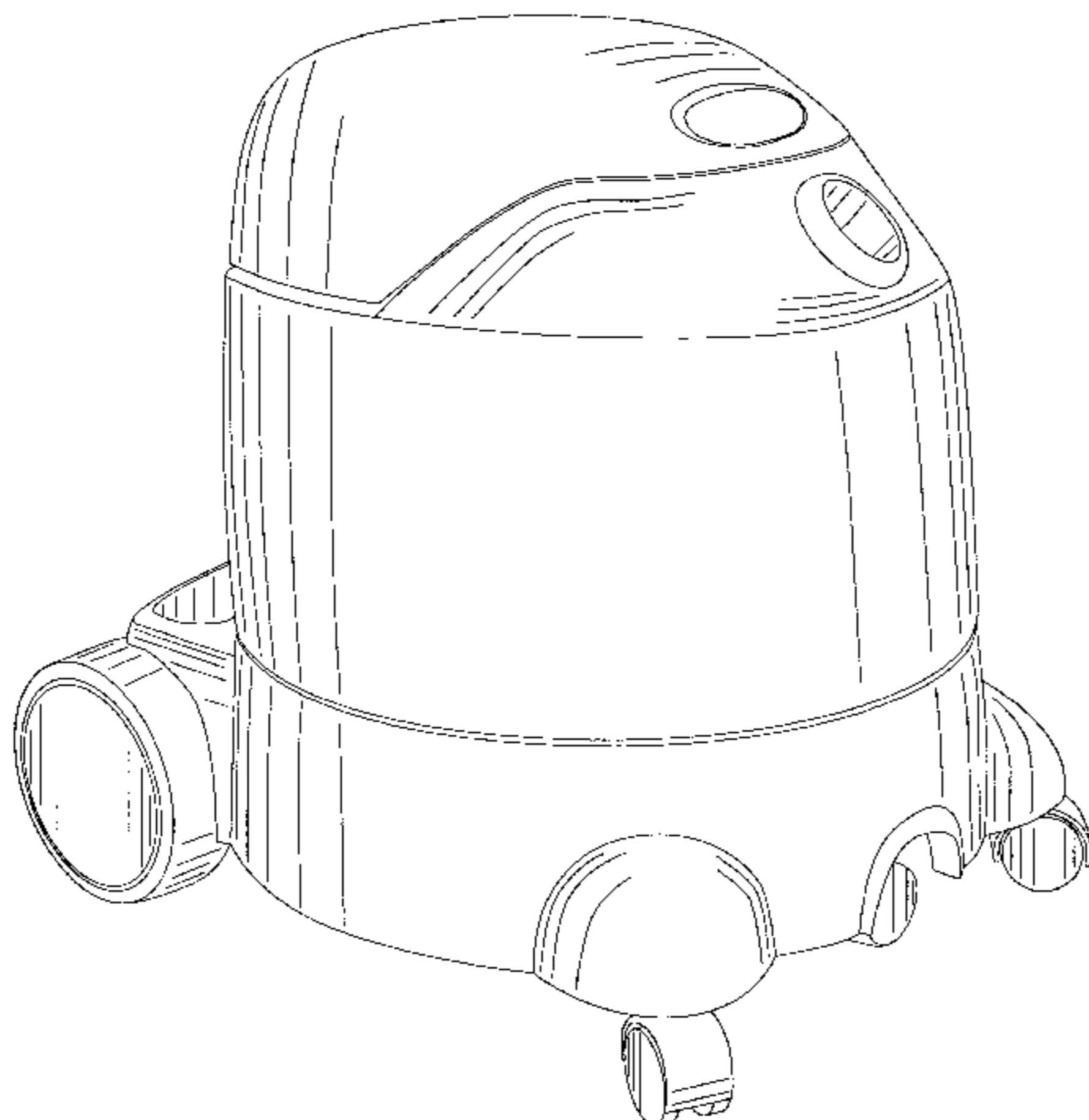

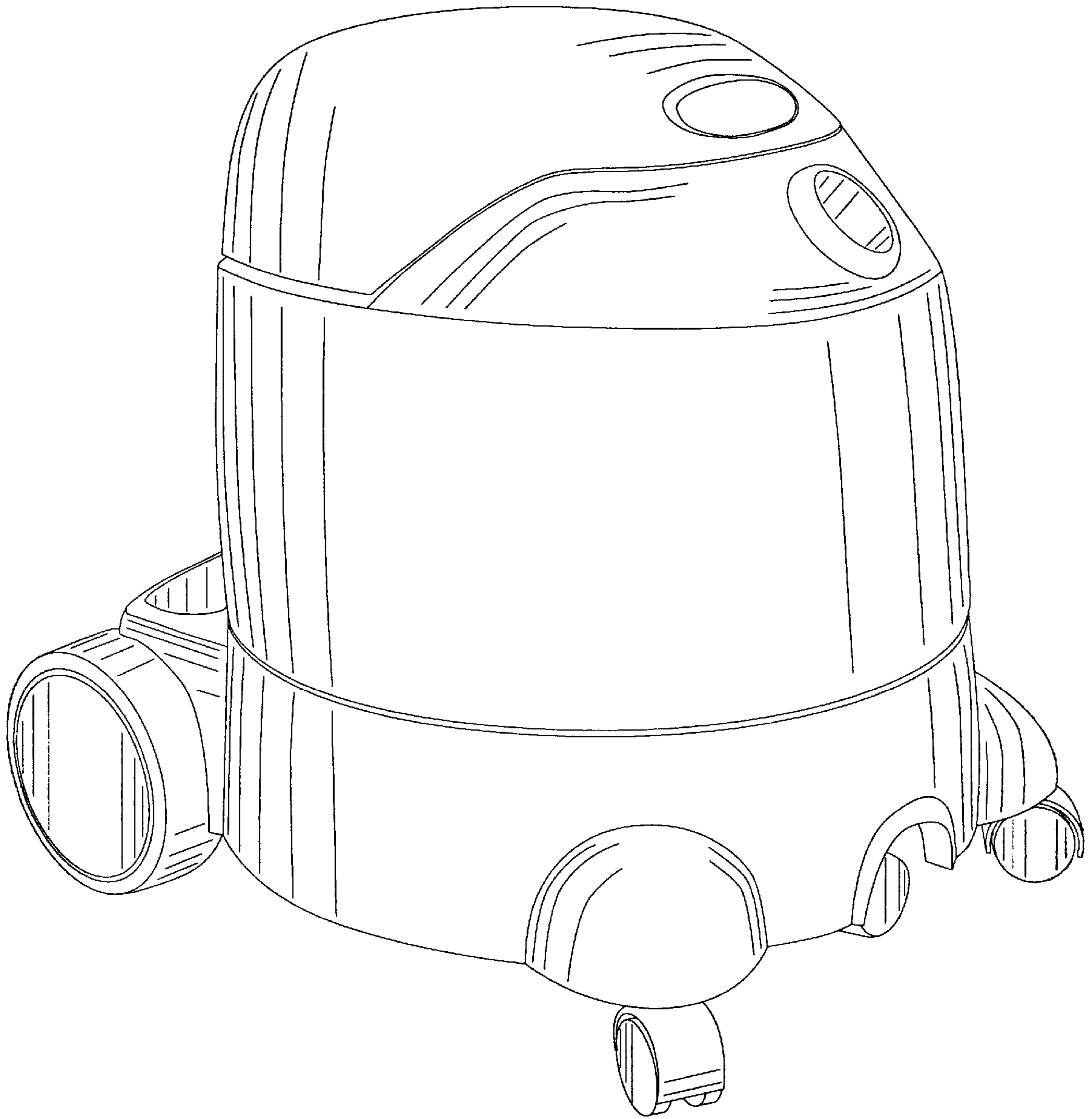

FIG. 1

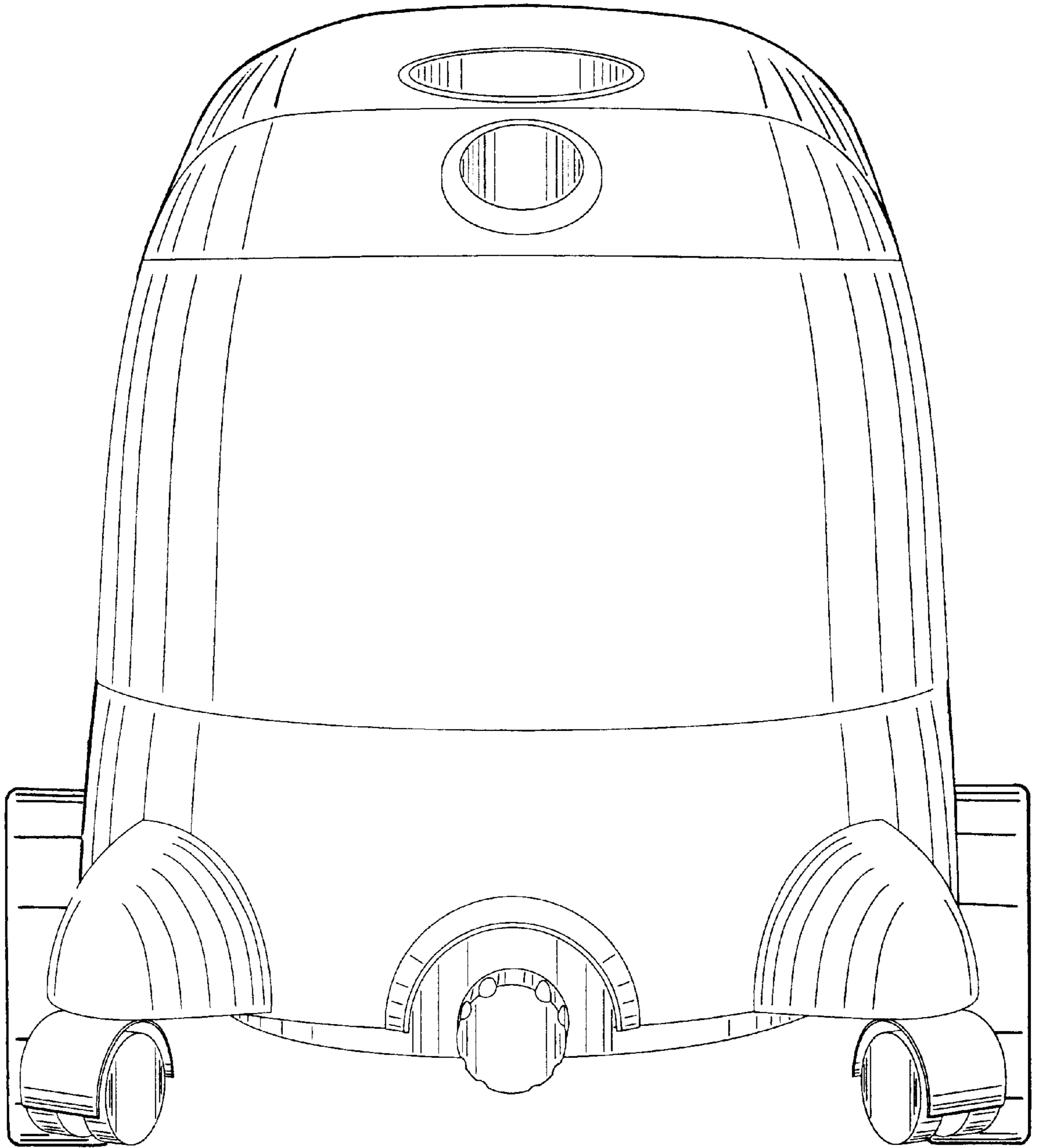

FIG. 2

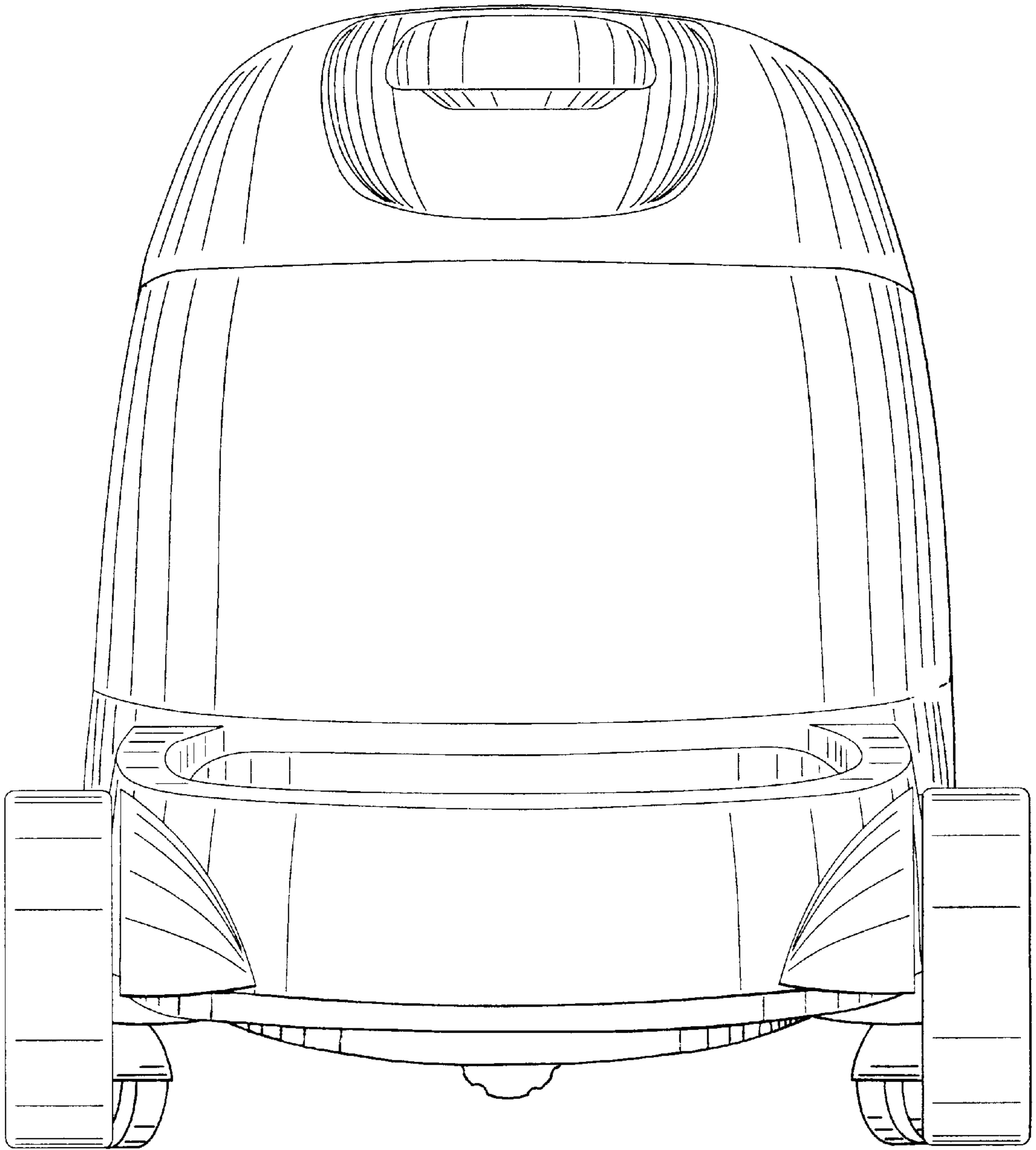

FIG. 3

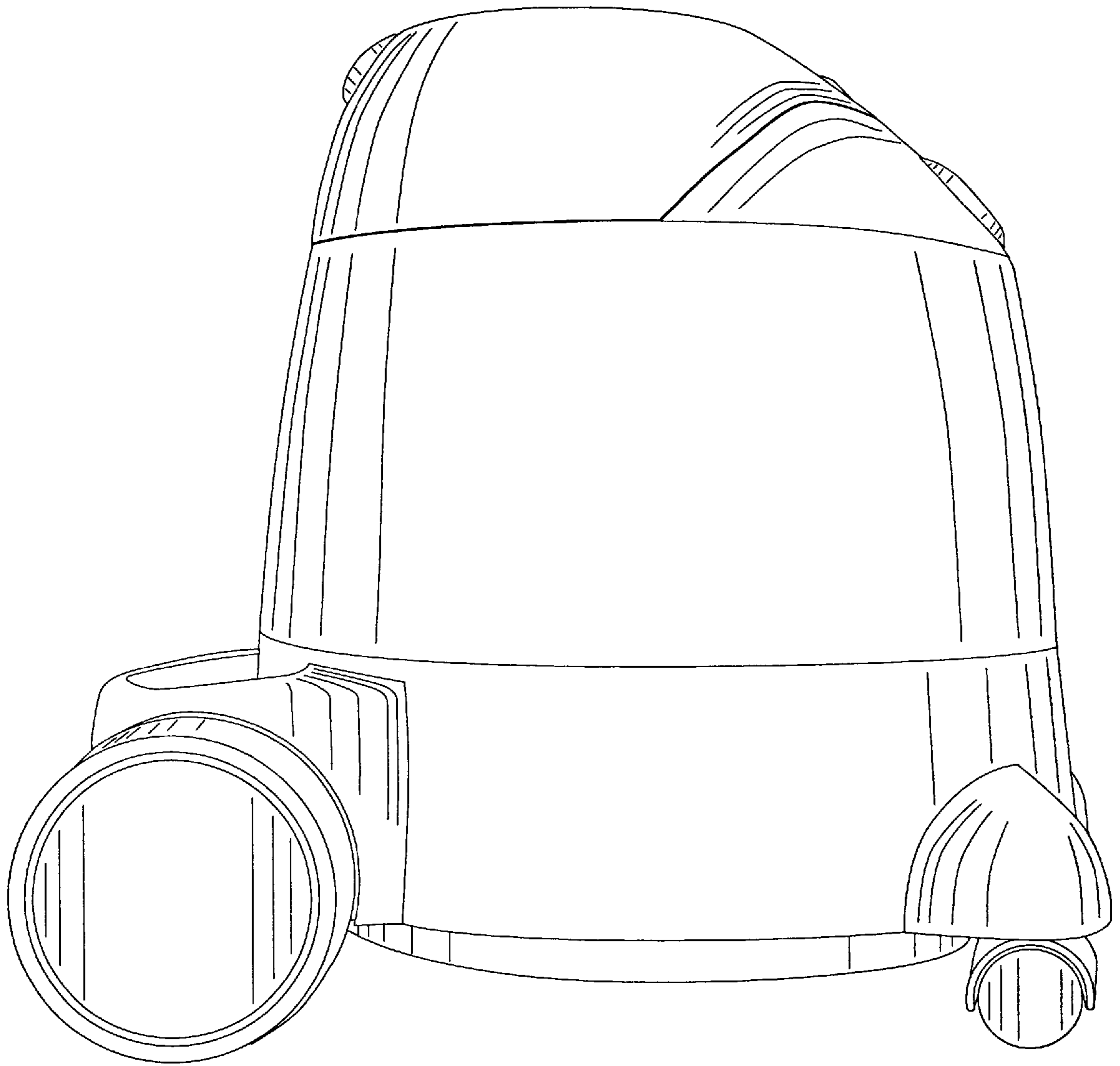

FIG. 4

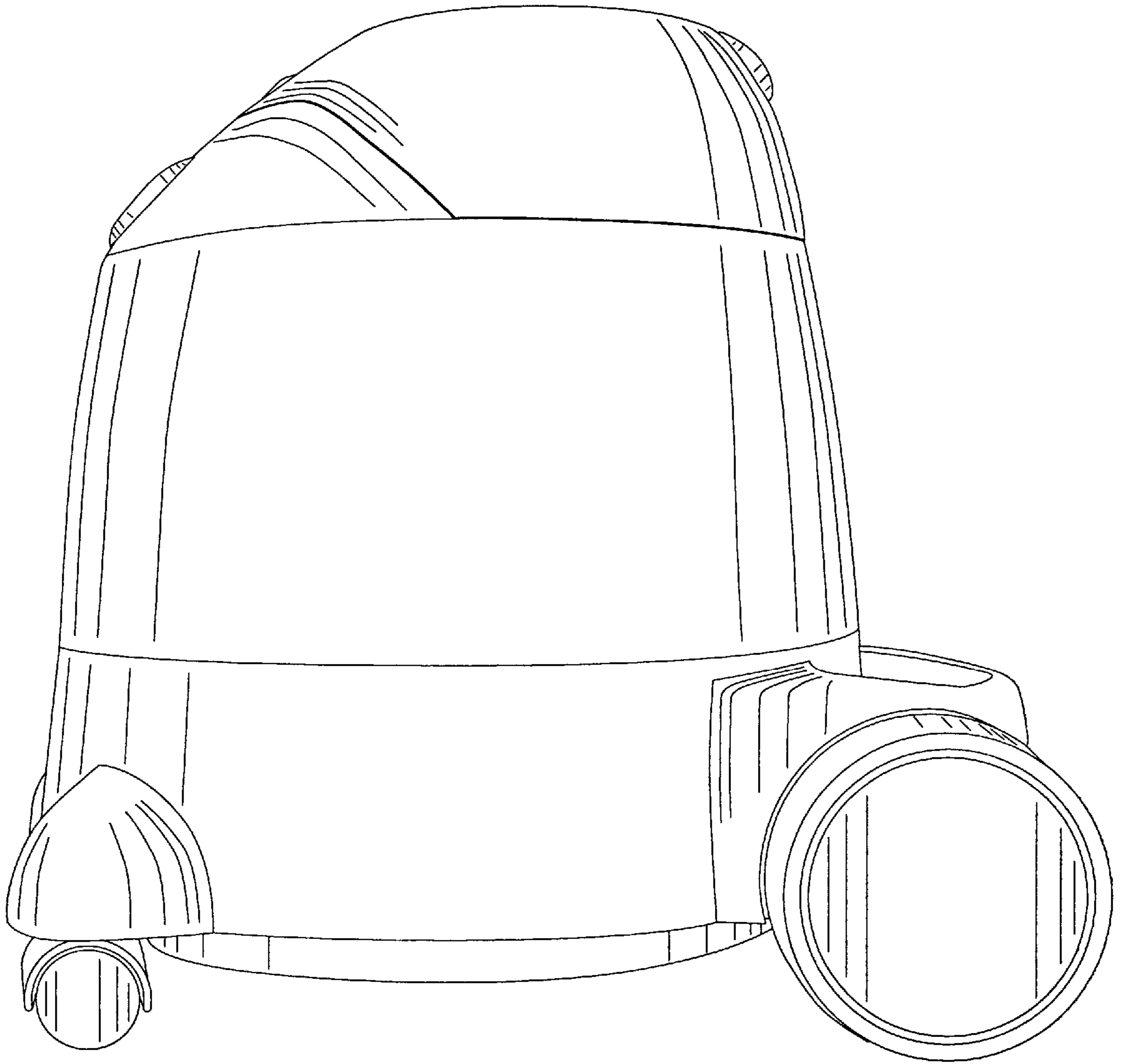

FIG. 5

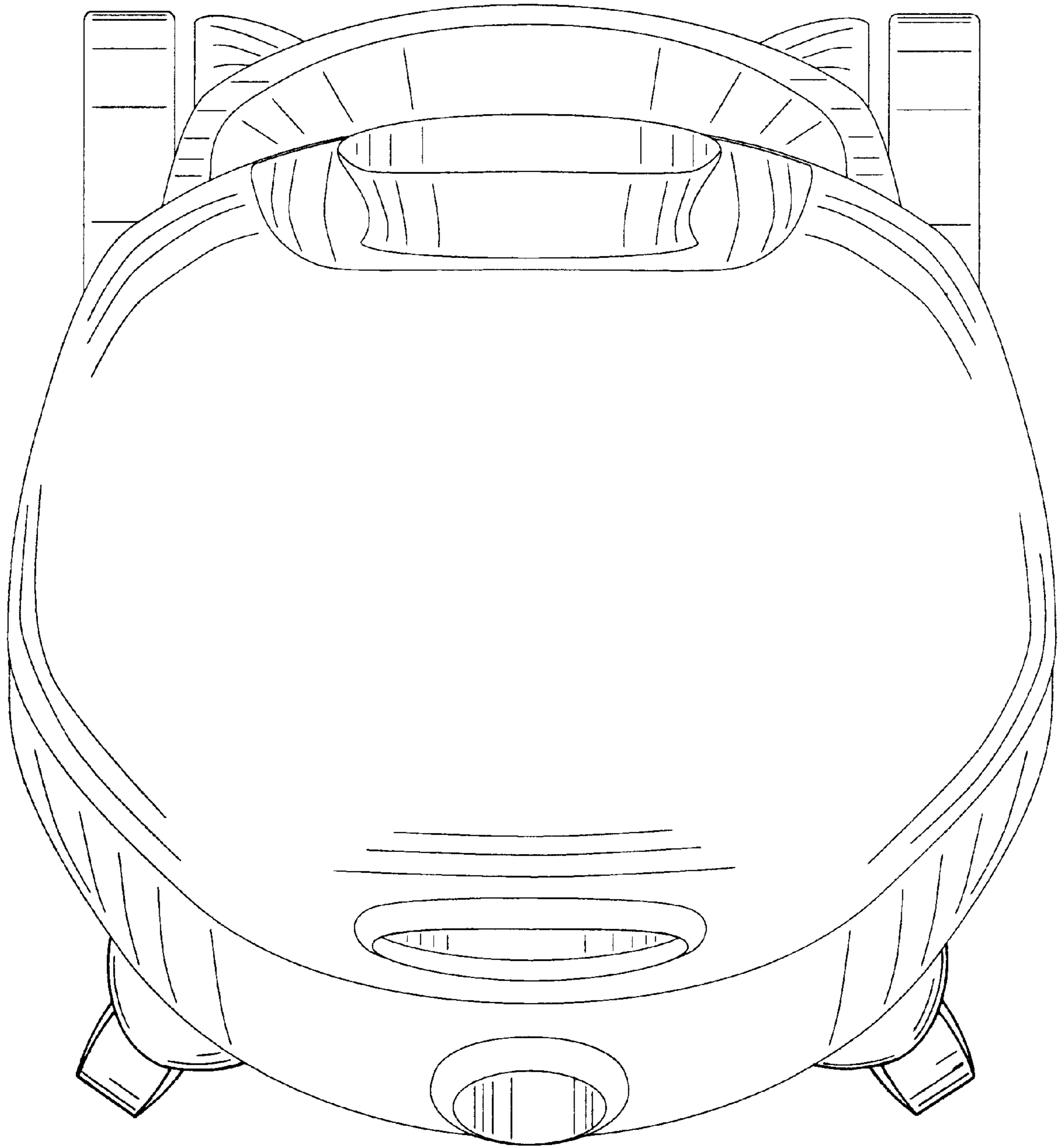

FIG. 6

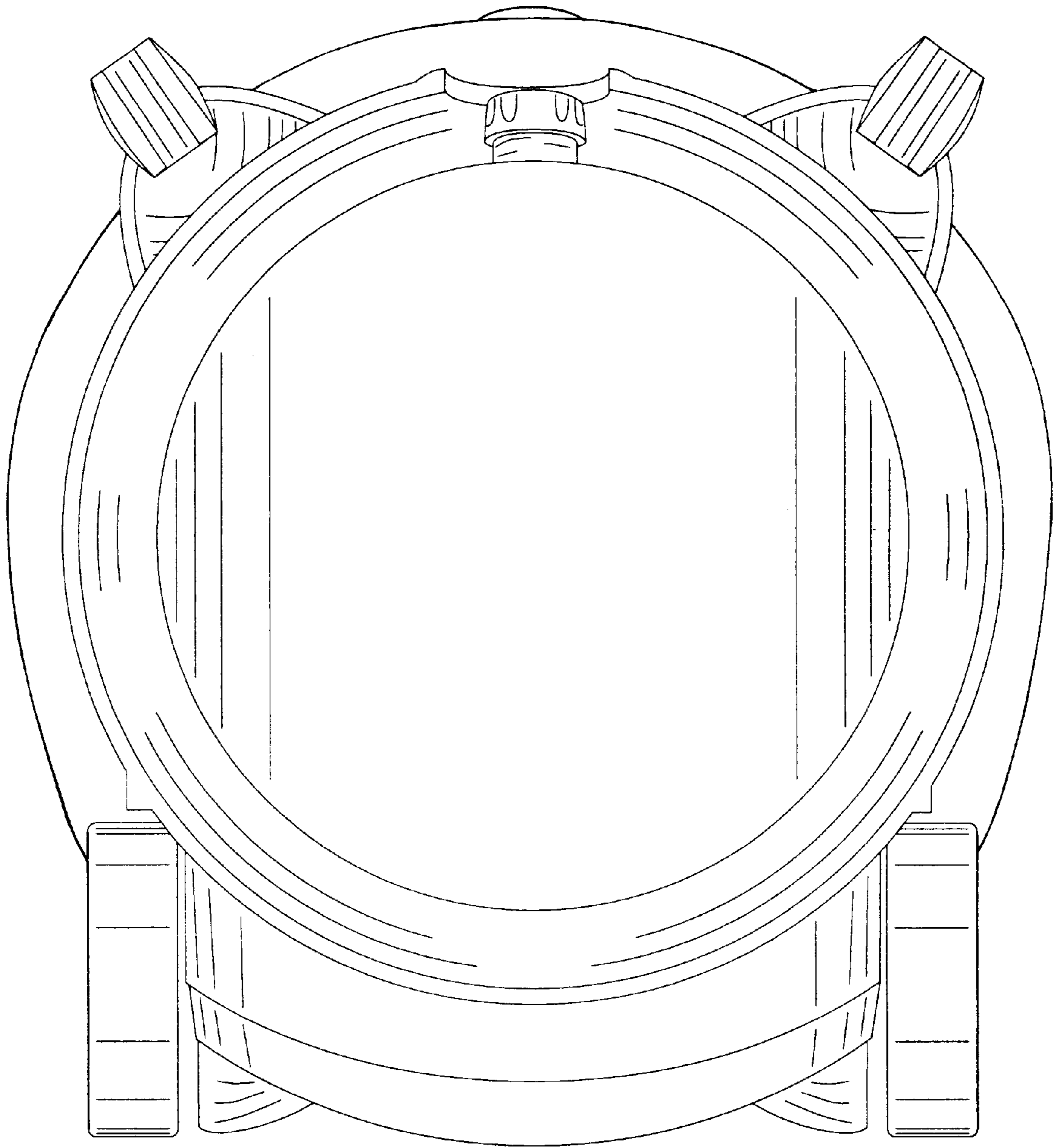

FIG. 7