



US00D445460S

(12) **United States Design Patent**
Lee

(10) **Patent No.:** **US D445,460 S**

(45) **Date of Patent:** **** Jul. 24, 2001**

(54) **ANIMAL TOY**

(75) **Inventor:** **Kun Kap Lee, Seoul (KR)**

(73) **Assignee:** **Toytron Co. Ltd., Seoul (KR)**

(**) **Term:** **14 Years**

(21) **Appl. No.:** **29/135,631**

(22) **Filed:** **Jan. 16, 2001**

(30) **Foreign Application Priority Data**

Oct. 23, 2000 (KR) 00-26915

(51) **LOC (7) Cl.** **21-01**

(52) **U.S. Cl.** **D21/428**

(58) **Field of Search** D21/419, 424,
D21/426, 427, 428, 435, 533, 548, 576,
613; 446/465, 470, 29, 269, 97, 153, 226,
268, 296, 369; 280/1.13, 87.01, 87.021,
828

(56) **References Cited**

U.S. PATENT DOCUMENTS

D. 295,200 * 4/1988 Hardiman et al. D21/613

D. 310,685 * 9/1990 Berger D21/428
D. 371,812 * 7/1996 Veraguth D21/428
D. 400,952 * 11/1998 Jensen et al. D21/428
D. 418,554 * 1/2000 E D21/613
4,741,544 * 5/1988 Kassai 280/1.13

* cited by examiner

Primary Examiner—Raphael Barkai

(74) *Attorney, Agent, or Firm*—Rosenthal & Osha, L.L.P.

(57) **CLAIM**

The ornamental design for animal toy, as shown and described.

DESCRIPTION

FIG. 1 is perspective view of the animal toy;
FIG. 2 is a front view thereof;
FIG. 3 is a rear view thereof;
FIG. 4 is a left side view thereof;
FIG. 5 is a right side view thereof;
FIG. 6 is a top plan view thereof; and,
FIG. 7 is a bottom plan view thereof.

1 Claim, 7 Drawing Sheets

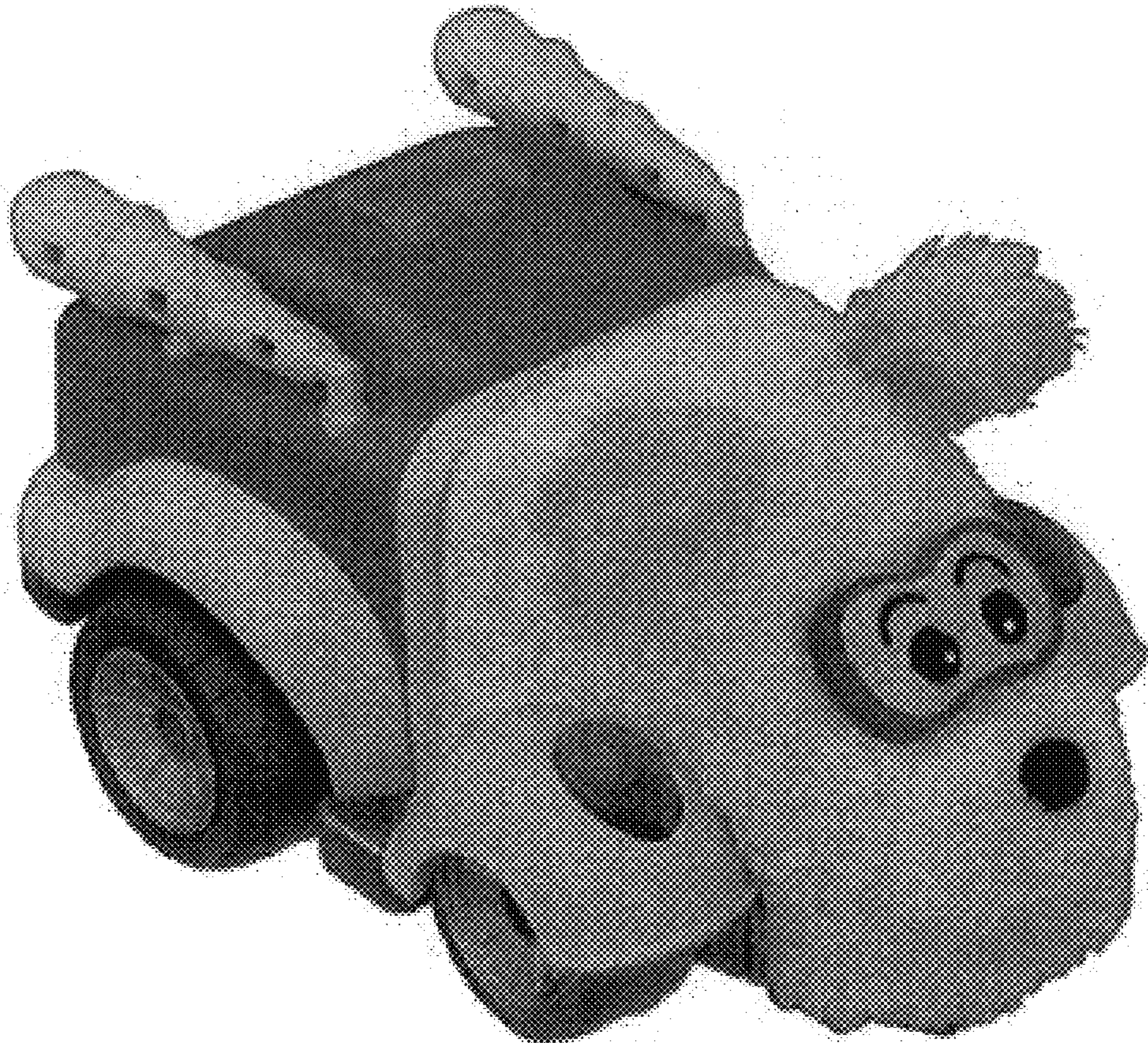

Fig. 1

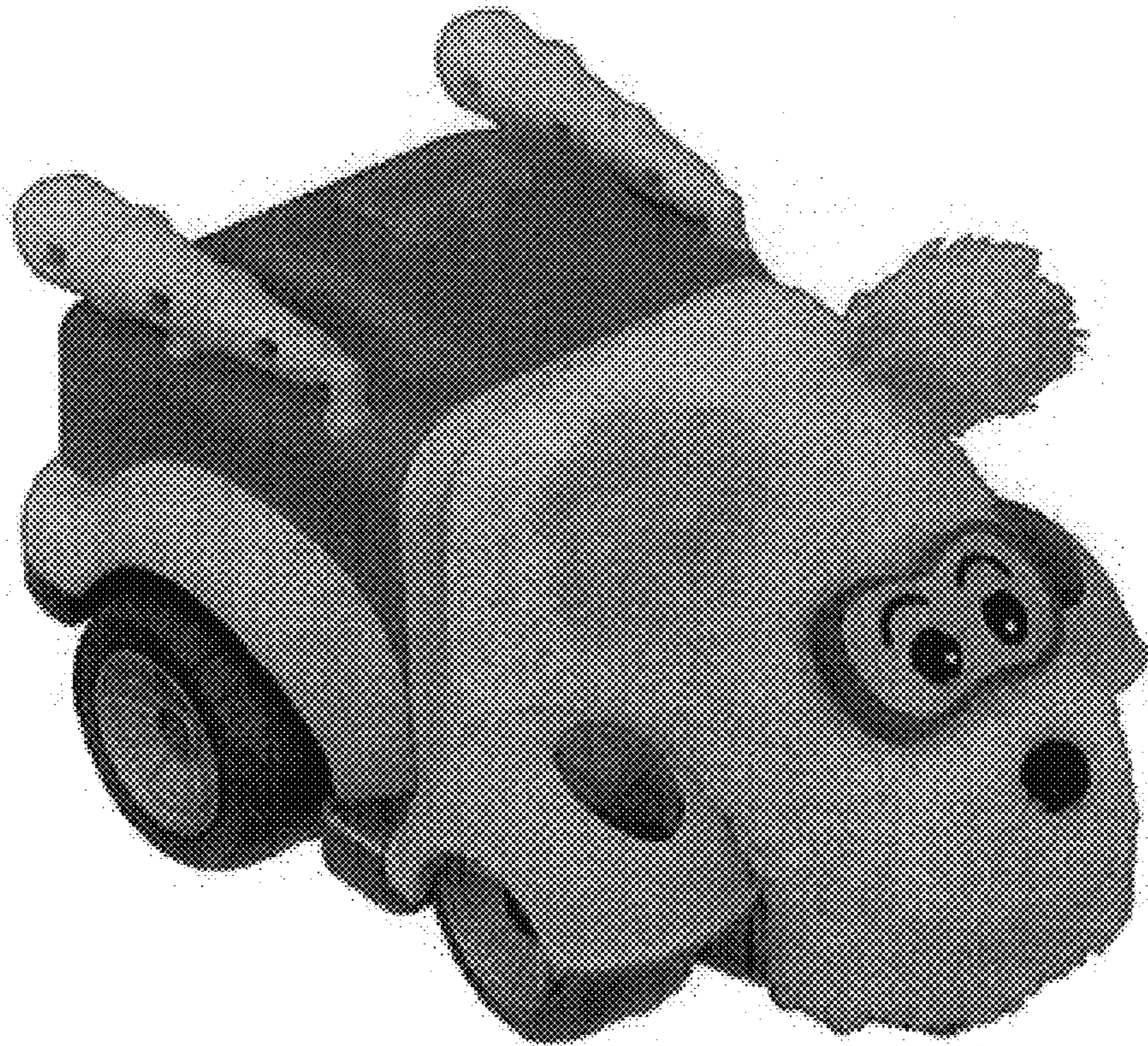

Fig. 2

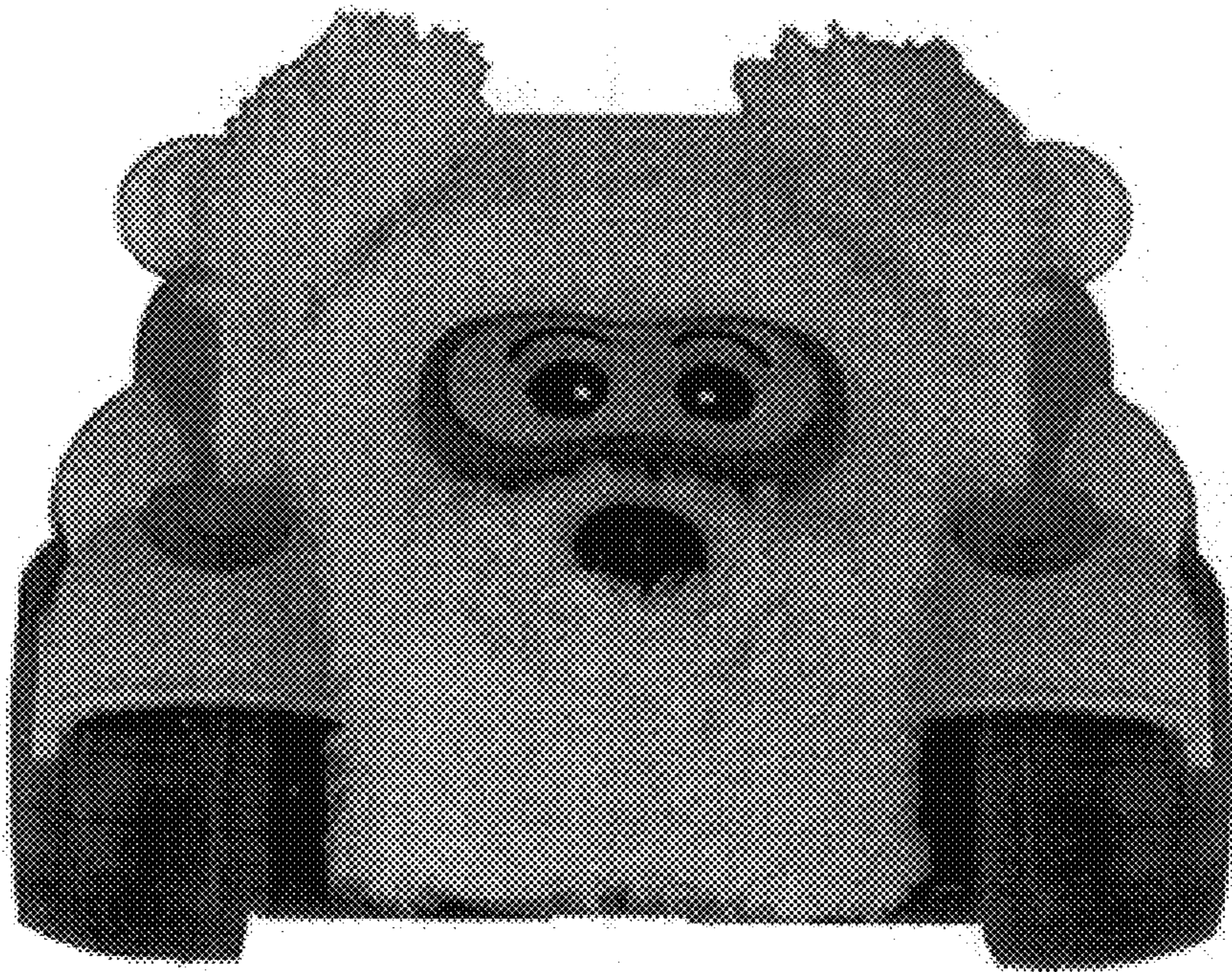

Fig. 3

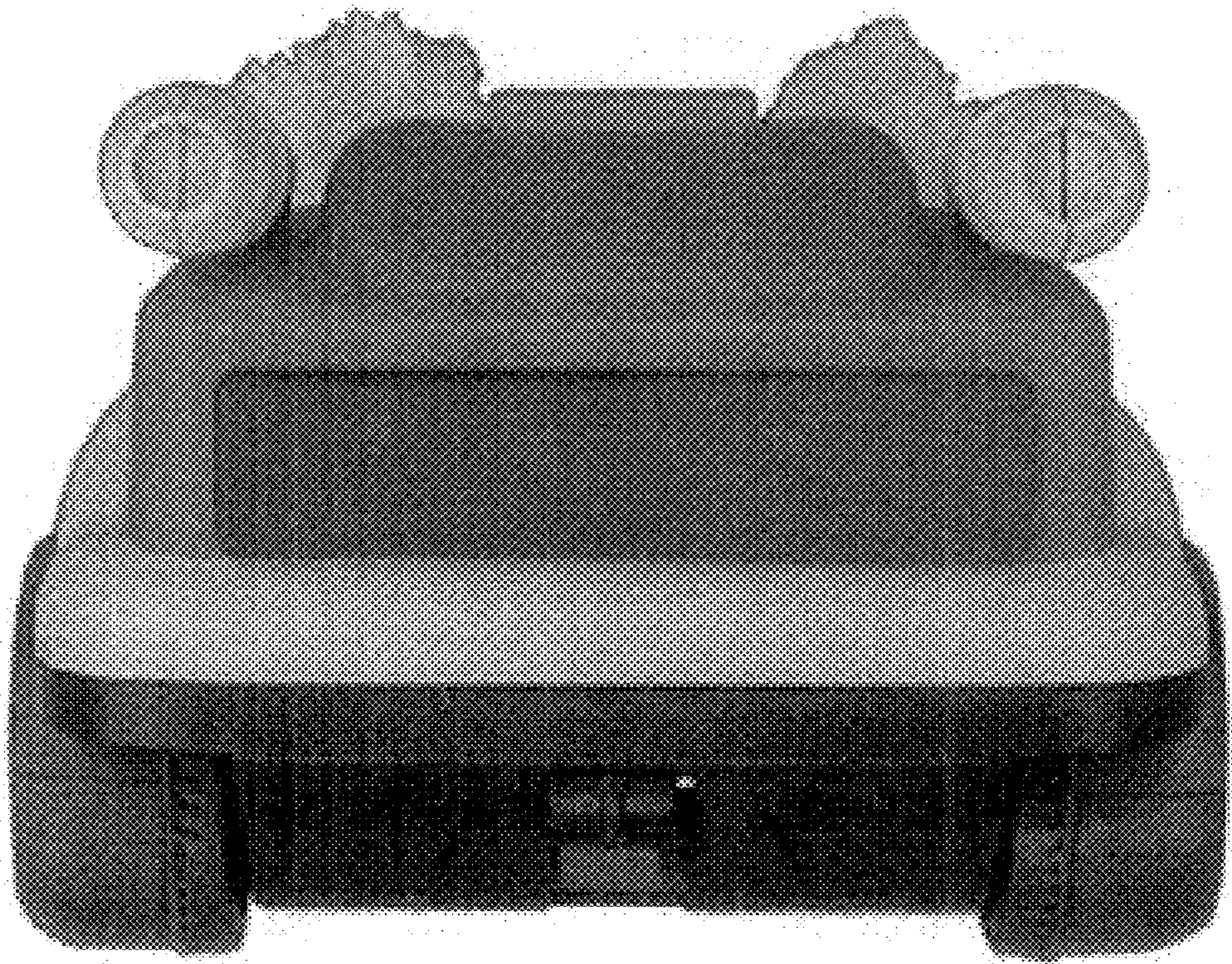

Fig. 4

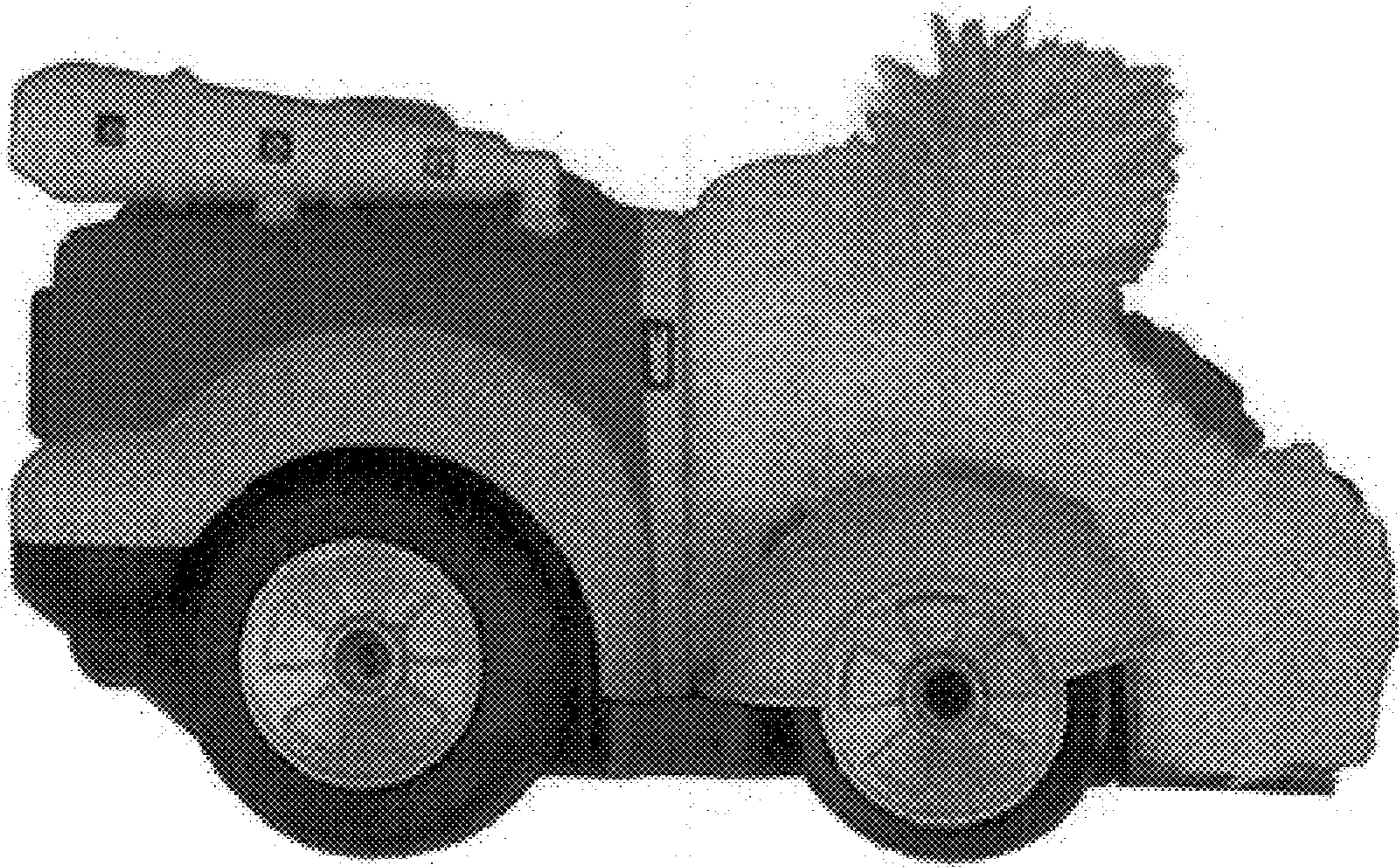

Fig. 5

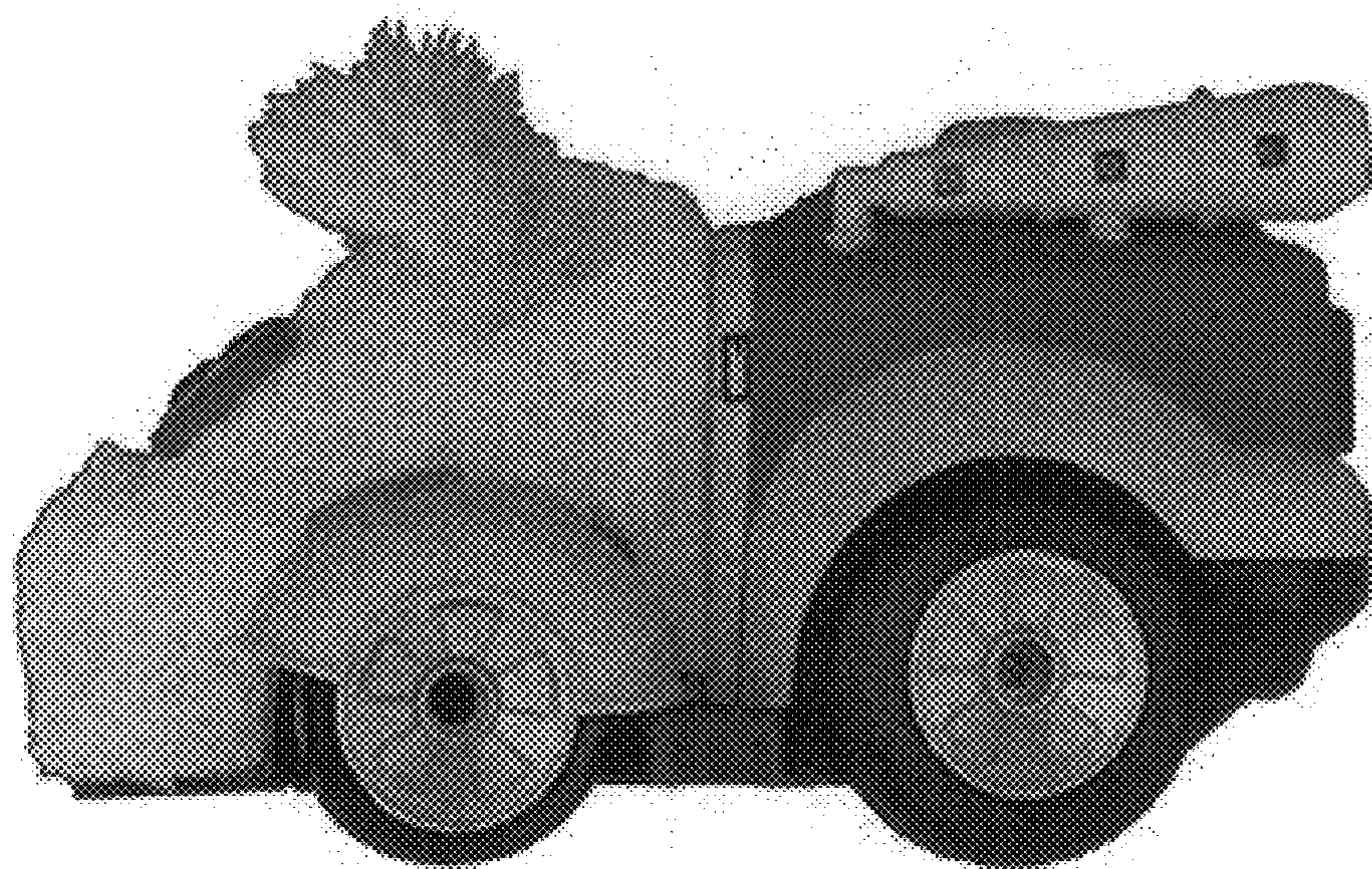

Fig. 6

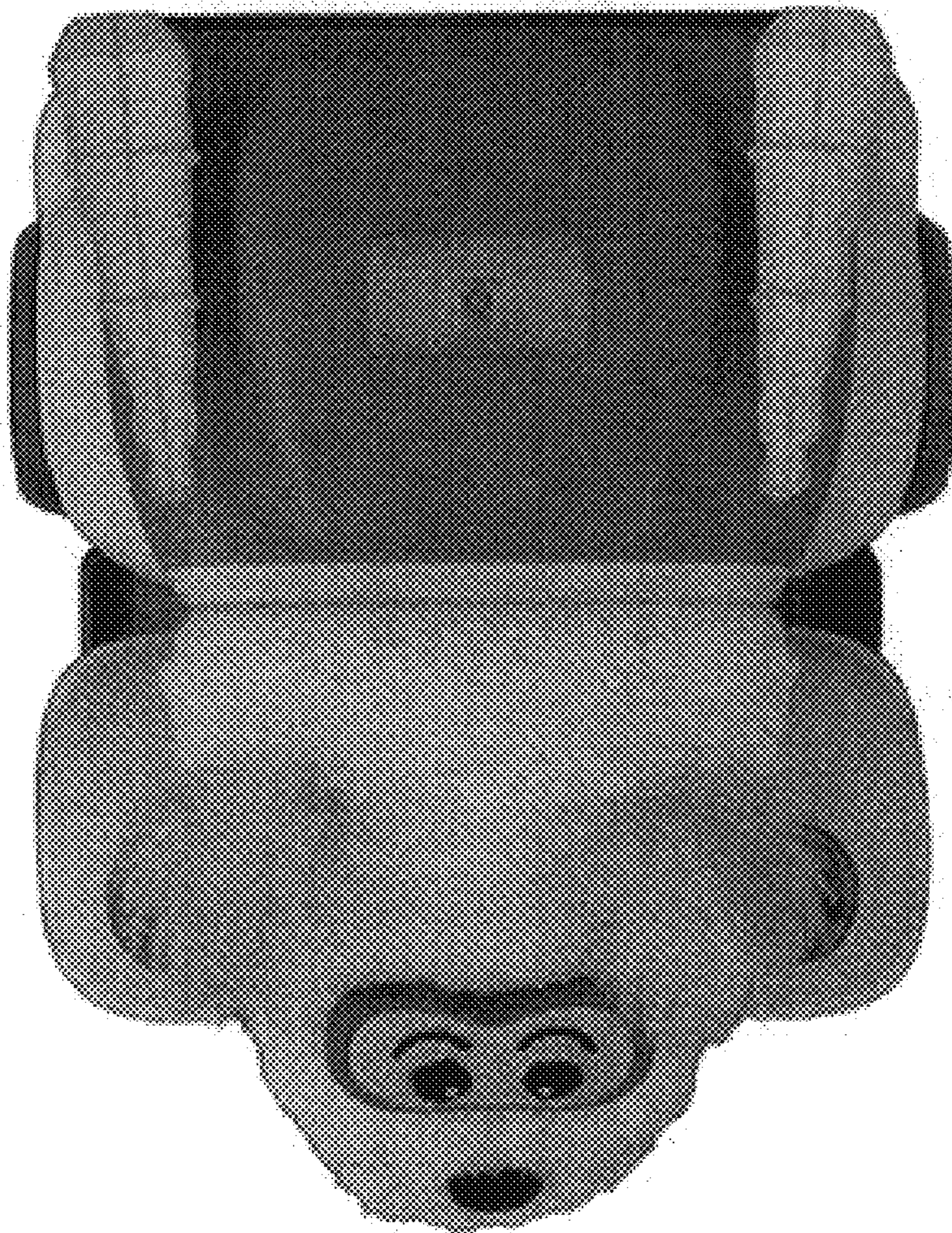

Fig. 7

