



US00D445309S

(12) **United States Design Patent** (10) **Patent No.:** **US D445,309 S**
Menow et al. (45) **Date of Patent:** **** Jul. 24, 2001**

(54) **BREAKFAST CEREAL DISPENSER**

(75) Inventors: **Steven M. Menow**, Fairfield, CA (US);
Todd Hannon, Burlington, WI (US);
Tom Chrisman, Villa Park, IL (US)

(73) Assignee: **Oddzon, Inc.**, Pawtucket, RI (US)

(**) Term: **14 Years**

(21) Appl. No.: **29/124,144**

(22) Filed: **May 30, 2000**

(51) **LOC (7) Cl.** **07-01**

(52) **U.S. Cl.** **D7/628; D9/329**

(58) **Field of Search** D7/601, 602, 628,
D7/629; D9/307, 329; 220/526, 555, 556,
574, 575, 377; 206/457

(56) **References Cited**

U.S. PATENT DOCUMENTS

D. 323,768	*	2/1992	Corthum	D9/307
D. 340,625	*	10/1993	Wang	D7/629
D. 409,084	*	5/1999	Sims et al.	D9/329
5,009,341		4/1991	Broxton	222/130

* cited by examiner

Primary Examiner—Terry A. Wallace

(74) *Attorney, Agent, or Firm*—Marshall, O'Toole,
Gerstein, Murray & Borun

(57) **CLAIM**

The ornamental design for a breakfast cereal dispenser, as shown and described.

DESCRIPTION

FIG. 1 is a front view of a breakfast cereal dispenser;

FIG. 2 is a rear view of the breakfast cereal dispenser of FIG. 1;

FIG. 3 is a left side view of the breakfast cereal dispenser of FIG. 1;

FIG. 4 is a right side view of the breakfast cereal dispenser of FIG. 1;

FIG. 5 is a top view of the breakfast cereal dispenser of FIG. 1; and,

FIG. 6 is a bottom view of the breakfast cereal dispenser of FIG. 1.

1 Claim, 5 Drawing Sheets

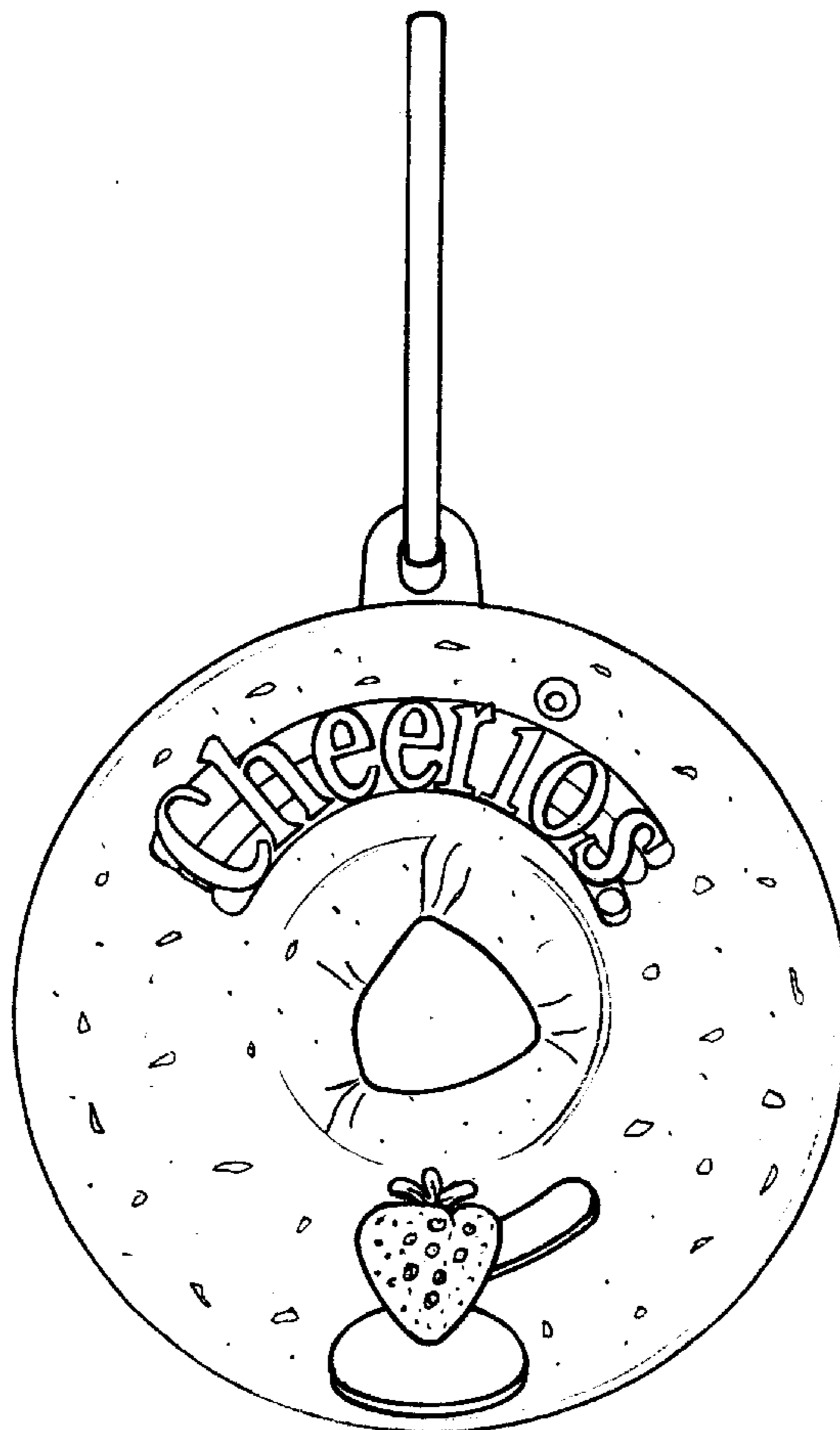

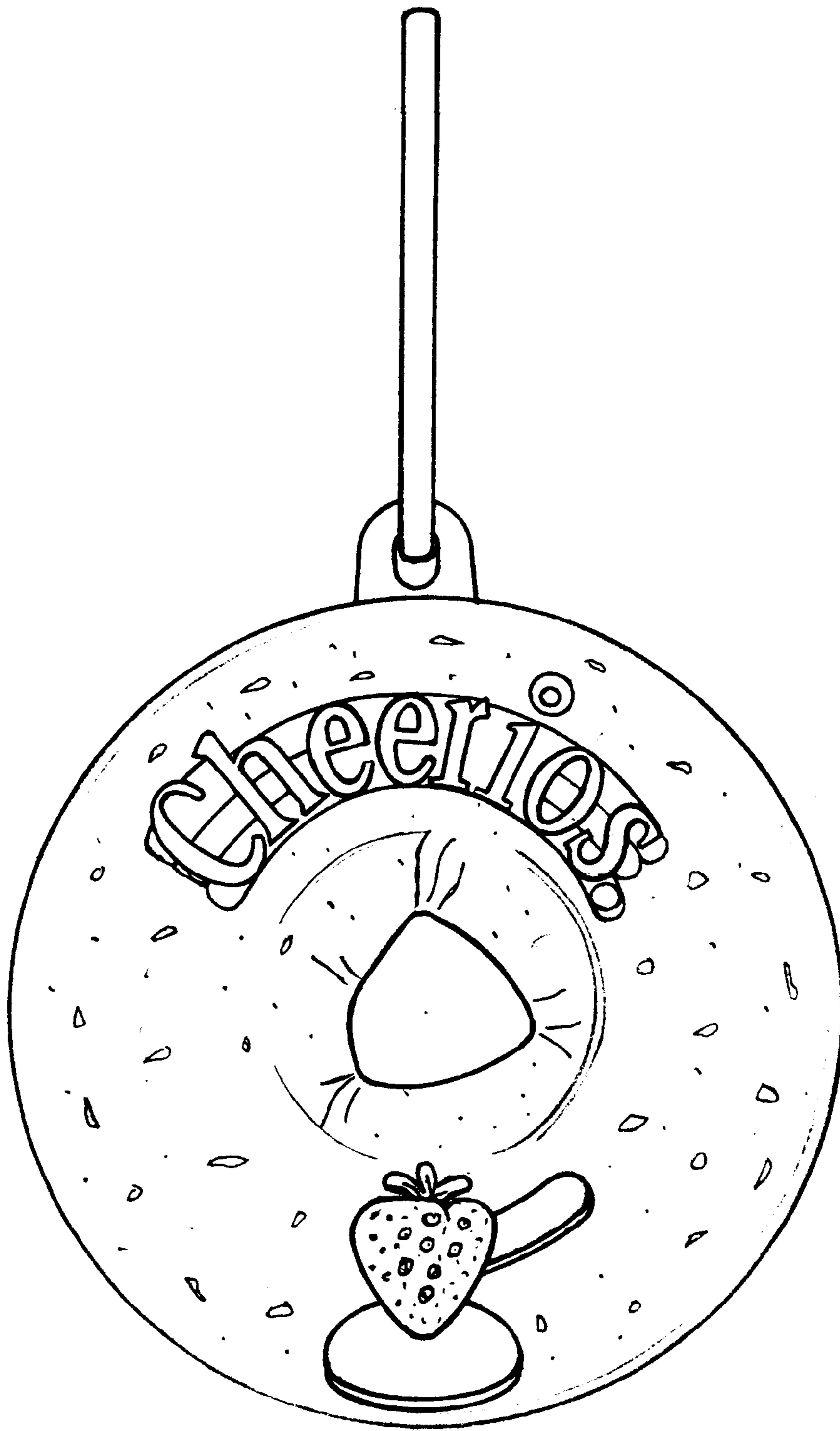

FIG. 1

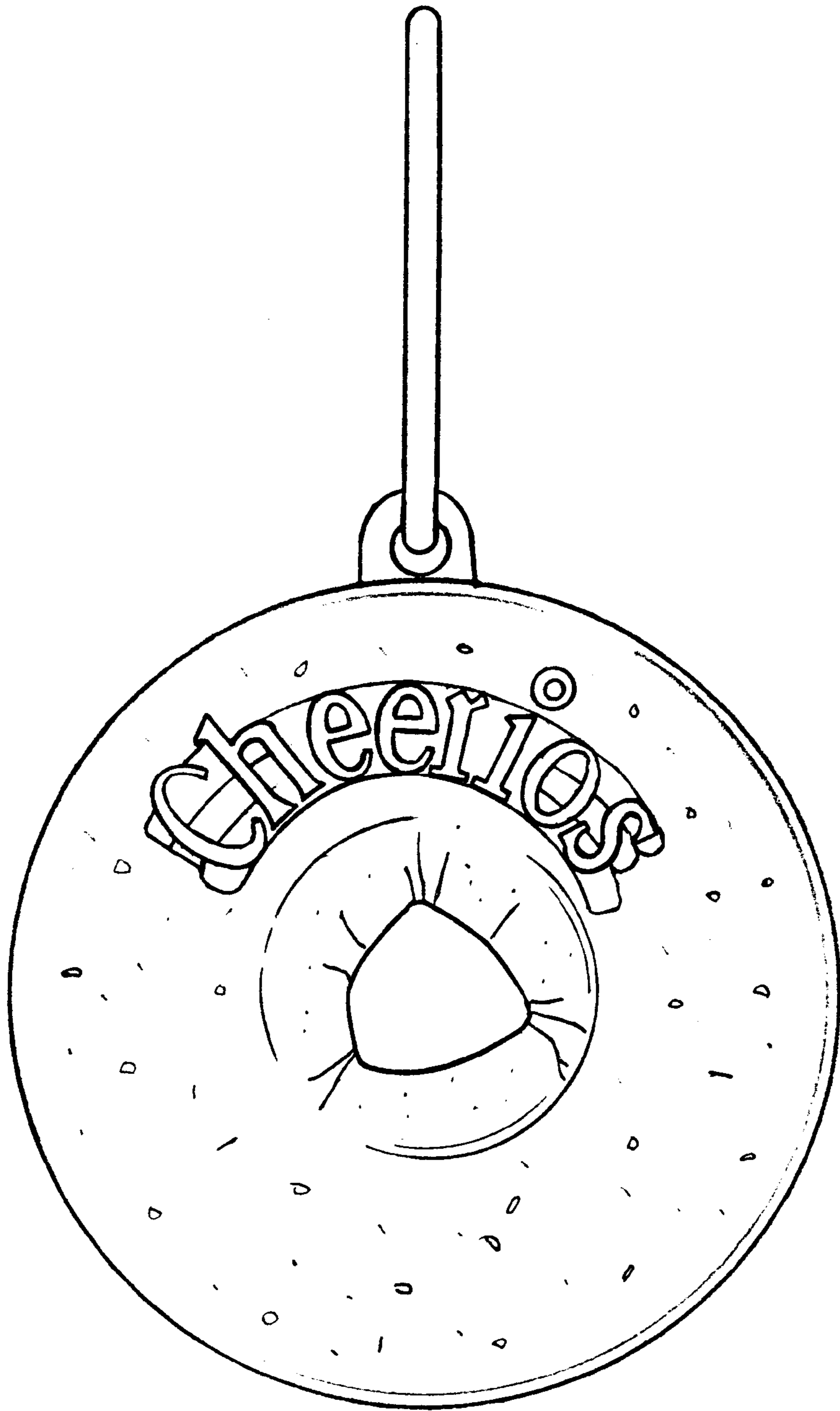

FIG. 2

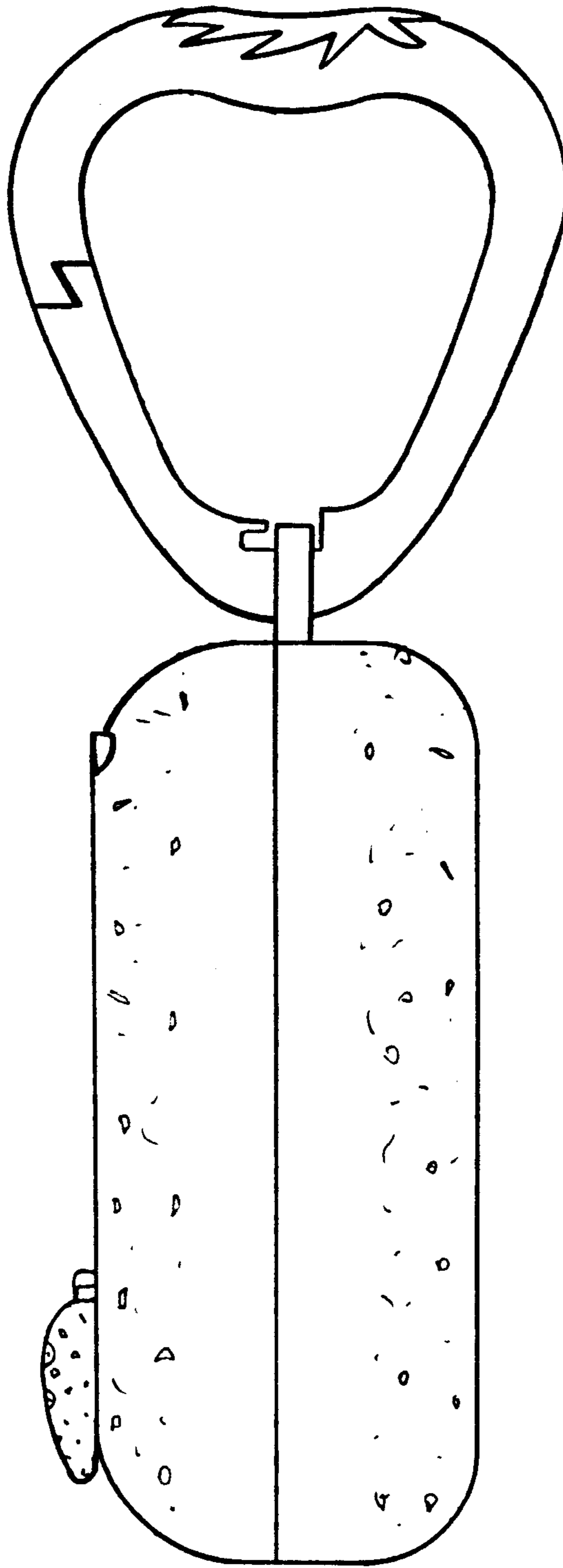

FIG. 3

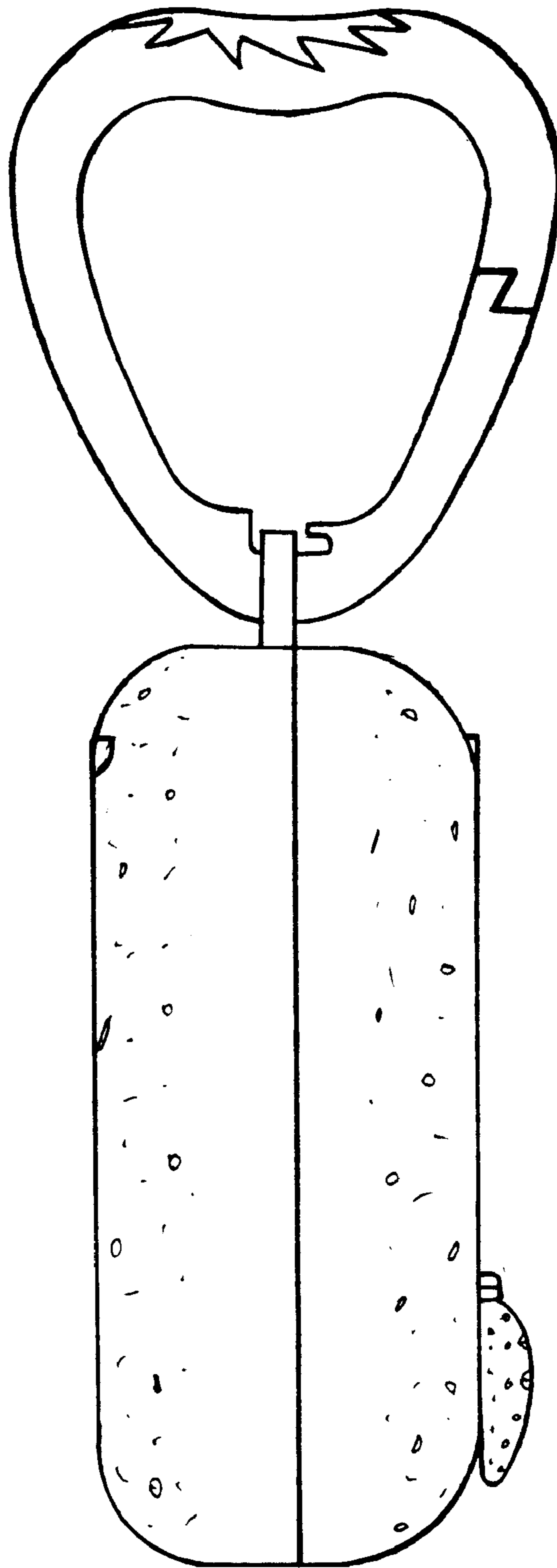

FIG. 4

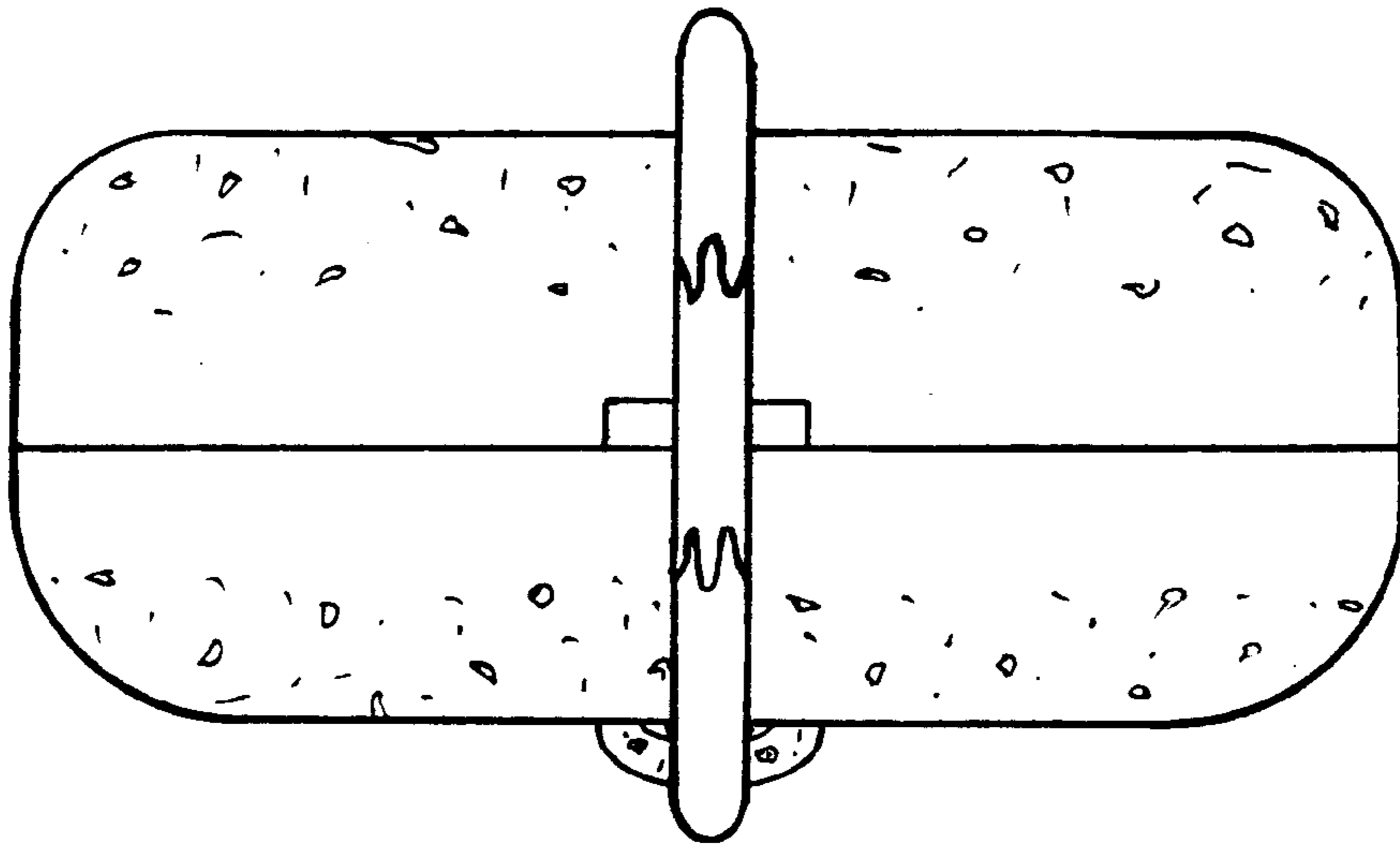

FIG. 5

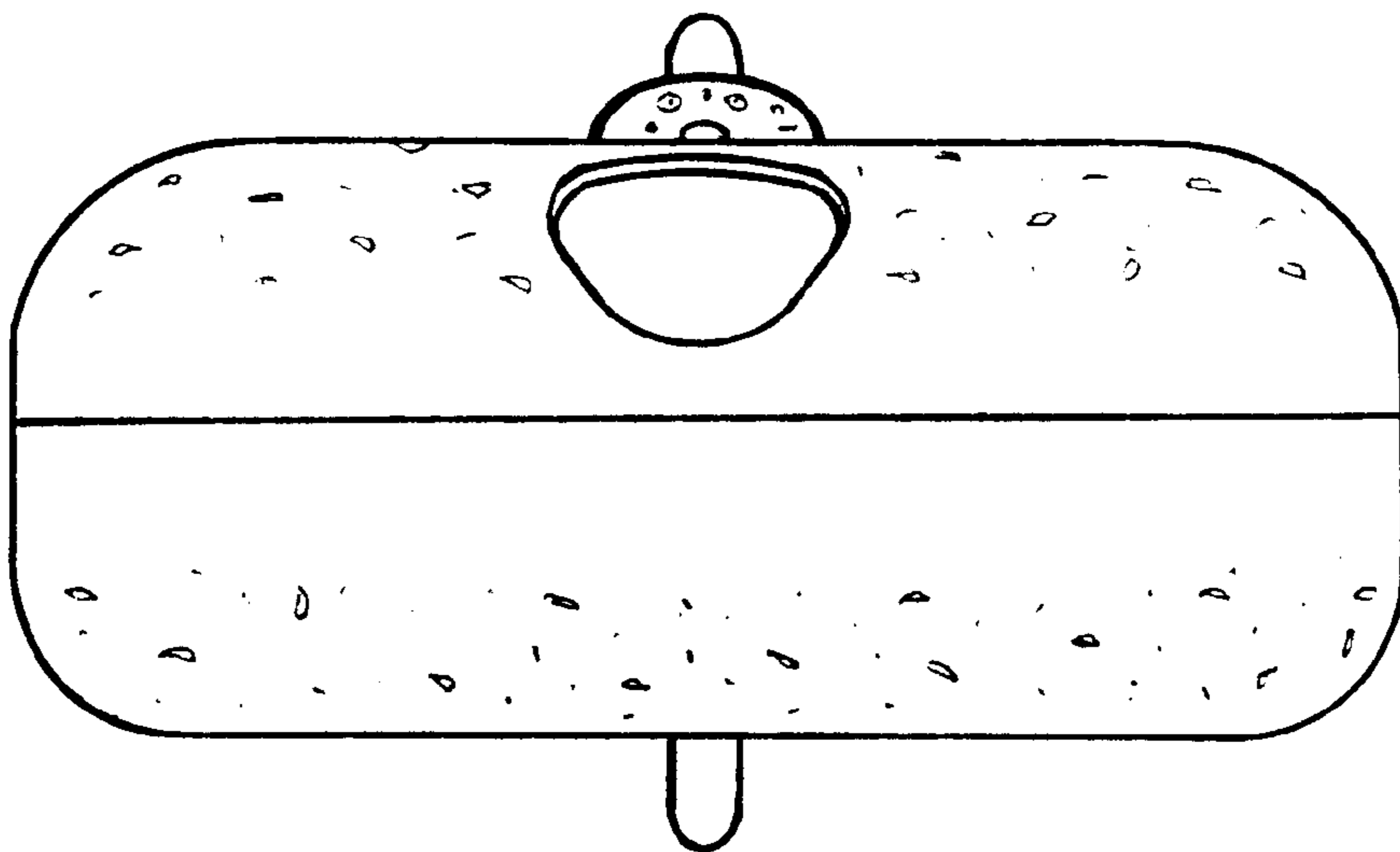

FIG. 6